

# YASKAWA AC Drive-J1000

## Compact V/f Control Drive

## Quick Start Guide

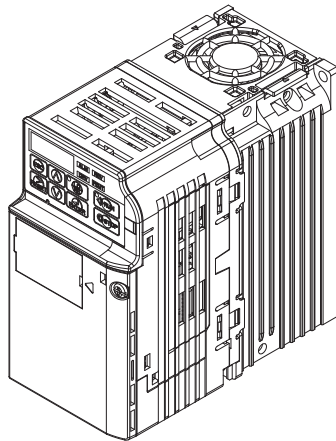
Type: CIMR-JU

Models: 200 V Class, Three-Phase Input: 0.1 to 5.5 kW

200 V Class, Single-Phase Input: 0.1 to 2.2 kW

400 V Class, Three-Phase Input: 0.2 to 5.5 kW

To properly use the product, read this manual thoroughly and retain for easy reference, inspection, and maintenance. Ensure the end user receives this manual.



Receiving

1

Mechanical Installation

2

Electrical Installation

3

Start-Up Programming & Operation

4

Troubleshooting

5

Periodic Inspection & Maintenance

6

Peripheral Devices & Options

7

Specifications

A

Parameter List

B

Standards Compliance

C

Copyright © 2008 YASKAWA ELECTRIC CORPORATION. All rights reserved.

All rights reserved. No part of this publication may be reproduced, stored in a retrieval system, or transmitted, in any form or by any means, mechanical, electronic, photocopying, recording, or otherwise, without the prior written permission of Yaskawa. No patent liability is assumed with respect to the use of the information contained herein. Moreover, because Yaskawa is constantly striving to improve its high-quality products, the information contained in this manual is subject to change without notice. Every precaution has been taken in the preparation of this manual. Yaskawa assumes no responsibility for errors or omissions. Neither is any liability assumed for damages resulting from the use of the information contained in this publication.

# Table of Contents

---

<b>i. PREFACE &amp; GENERAL SAFETY .....</b>	<b>9</b>
<b>i.1 Preface .....</b>	<b>10</b>
Applicable Documentation .....	10
Symbols.....	10
Terms and Abbreviations.....	10
<b>i.2 General Safety .....</b>	<b>11</b>
Supplemental Safety Information.....	11
Safety Messages .....	12
Drive Label Warnings .....	15
Warranty Information .....	16
Quick Reference.....	16
<b>1. RECEIVING .....</b>	<b>17</b>
<b>1.1 Section Safety.....</b>	<b>18</b>
<b>1.2 Model Number and Nameplate Check.....</b>	<b>19</b>
Nameplate.....	19
<b>1.3 Component Names .....</b>	<b>22</b>
IP20/Open-Chassis .....	22
Front Views .....	24
<b>2. MECHANICAL INSTALLATION .....</b>	<b>25</b>

<b>2.1</b>	<b>Section Safety</b> .....	<b>26</b>
<b>2.2</b>	<b>Mechanical Installation</b> .....	<b>29</b>
	Installation Environment .....	29
	Installation Orientation and Spacing.....	30
	Exterior and Mounting Dimensions .....	32
<b>3.</b>	<b>ELECTRICAL INSTALLATION</b> .....	<b>35</b>
<b>3.1</b>	<b>Section Safety</b> .....	<b>36</b>
<b>3.2</b>	<b>Standard Connection Diagram</b> .....	<b>39</b>
<b>3.3</b>	<b>Main Circuit Connection Diagram</b> .....	<b>42</b>
	Single-Phase 200 V Class Models BA0001 to BA0010 .....	42
	Three-Phase 200 V Class Models 2A0001 to 2A0020 .....	42
	Three-Phase 400 V Class Models 4A0001 to 4A0011 .....	42
<b>3.4</b>	<b>Terminal Block Configuration</b> .....	<b>43</b>
<b>3.5</b>	<b>Protective Covers</b> .....	<b>44</b>
	IP20/Open-Chassis Cover Removal and Installation.....	44
<b>3.6</b>	<b>Main Circuit Wiring</b> .....	<b>46</b>
	Main Circuit Terminal Functions .....	46
	Wire Gauges and Tightening Torques .....	46
	Main Circuit Terminal Power Supply and Motor Wiring.....	49
<b>3.7</b>	<b>Control Circuit Wiring</b> .....	<b>52</b>
	Control Circuit Terminal Block Functions.....	53
	Terminal Configuration.....	54
	Wiring Procedure.....	56
<b>3.8</b>	<b>I/O Connections</b> .....	<b>59</b>
	Sinking/Sourcing Mode Switch.....	59
<b>3.9</b>	<b>Main Frequency Reference</b> .....	<b>62</b>
	DIP Switch S1 Analog Input Signal Selection.....	62
<b>3.10</b>	<b>Braking Resistor</b> .....	<b>64</b>
	Installation.....	64
<b>3.11</b>	<b>Interlocking with Connected Machinery</b> .....	<b>66</b>
	Drive Ready Signal .....	66
<b>3.12</b>	<b>Wiring Checklist</b> .....	<b>67</b>

<b>4. START-UP PROGRAMMING &amp; OPERATION.....</b>	<b>69</b>
<b>4.1 Section Safety.....</b>	<b>70</b>
<b>4.2 Using the Digital LED Operator.....</b>	<b>73</b>
Keys, Displays, and LEDs.....	73
Digital Text Display .....	75
LED Screen Displays.....	76
LO/RE LED and RUN LED Indications .....	76
Menu Structure for Digital LED Operator.....	78
<b>4.3 The Drive and Programming Modes .....</b>	<b>79</b>
Navigating the Drive and Programming Modes.....	80
Changing Parameter Settings or Values .....	83
Verifying Parameter Changes: Verify Menu .....	84
Switching Between LOCAL and REMOTE.....	85
Parameters Available in the Setup Group.....	86
<b>4.4 Start-up Flowchart .....</b>	<b>87</b>
Flowchart: Basic Start-up.....	87
<b>4.5 Basic Operation .....</b>	<b>88</b>
Initialize Parameter Values: A1-03.....	88
Frequency Reference Source: b1-01.....	88
Run Command Input Selection: b1-02.....	90
Stopping Method Selection: b1-03.....	92
Acceleration/Deceleration: C1-01 to C1-04.....	93
Drive Duty and Carrier Frequency Selection: C6-01 and C6-02 .....	95
Multi-Step Speed Operation (4-Step Speed).....	97
E1: V/f Characteristics .....	101
Motor Parameters: E2-01 to E2-03 .....	104
Digital Output: H2-01 .....	105
Analog Outputs: H4-01 to H4-03 .....	105
Motor Protection: L1-01 and L1-02 .....	107
Drive Status Monitors: U1-01 to U4-13 .....	110
<b>4.6 Powering Up the Drive.....</b>	<b>112</b>
Powering Up the Drive and Operation Status Display .....	112
V/f Pattern Setting.....	113
<b>4.7 No-Load Operation Test Run .....</b>	<b>114</b>
No-Load Operation Test Run.....	114

## Table of Contents

---

<b>4.8</b>	<b>Test Run with Load Connected</b> .....	<b>116</b>
	Test Run with the Load Connected.....	116
<b>4.9</b>	<b>Verifying and Backing Up Parameter Settings</b> .....	<b>117</b>
	Parameter Access Level: A1-01.....	117
	Password Settings: A1-04, A1-05.....	117
	Copy Function (Optional).....	117
<b>4.10</b>	<b>Test Run Checklist</b> .....	<b>119</b>
<b>5.</b>	<b>TROUBLESHOOTING</b> .....	<b>121</b>
<b>5.1</b>	<b>Section Safety</b> .....	<b>122</b>
<b>5.2</b>	<b>Motor Performance Fine Tuning</b> .....	<b>125</b>
	Parameters for Tuning the Drive .....	125
	Motor Hunting and Oscillation Control Parameters .....	126
<b>5.3</b>	<b>Drive Alarms, Faults, and Errors</b> .....	<b>127</b>
	Types of Alarms, Faults, and Errors.....	127
	Alarm and Error Displays.....	128
<b>5.4</b>	<b>Fault Detection</b> .....	<b>130</b>
	Fault Displays, Causes, and Possible Solutions .....	130
<b>5.5</b>	<b>Alarm Detection</b> .....	<b>141</b>
	Alarm Codes, Causes, and Possible Solutions .....	141
<b>5.6</b>	<b>Operator Programming Errors</b> .....	<b>147</b>
	oPE Codes, Causes, and Possible Solutions .....	147
<b>5.7</b>	<b>Diagnosing and Resetting Faults</b> .....	<b>149</b>
	Fault Occurs Simultaneously with Power Loss .....	149
	If the Drive Still has Power After a Fault Occurs .....	149
	Viewing Fault History Data After Fault .....	149
	Fault Reset Methods .....	150
<b>5.8</b>	<b>Troubleshooting without Fault Display</b> .....	<b>151</b>
	Cannot Change Parameter Settings.....	151
	Motor Does Not Rotate Properly after Pressing RUN Button or after Entering External Run Command.....	152
<b>6.</b>	<b>PERIODIC INSPECTION &amp; MAINTENANCE</b> .....	<b>161</b>
<b>6.1</b>	<b>Section Safety</b> .....	<b>162</b>

<b>6.2</b>	<b>Inspection</b> .....	<b>165</b>
	Recommended Daily Inspection .....	165
	Recommended Periodic Inspection .....	166
<b>6.3</b>	<b>Periodic Maintenance</b> .....	<b>168</b>
	Replacement Parts .....	168
<b>6.4</b>	<b>Drive Cooling Fans</b> .....	<b>171</b>
	Number of Cooling Fans .....	171
	Cooling Fan Replacement .....	172
<b>7.</b>	<b>PERIPHERAL DEVICES &amp; OPTIONS</b> .....	<b>177</b>
<b>7.1</b>	<b>Section Safety</b> .....	<b>178</b>
<b>7.2</b>	<b>Drive Options and Peripheral Devices</b> .....	<b>180</b>
<b>7.3</b>	<b>Connecting Peripheral Devices</b> .....	<b>182</b>
<b>7.4</b>	<b>Installing Peripheral Devices</b> .....	<b>184</b>
	Installing a Molded Case Circuit Breaker (MCCB) and Earth Leakage Circuit Breaker (ELCB) .....	184
	Application Precautions when Installing a GFCI .....	185
	Installing a Magnetic Contactor .....	185
	Connecting an AC Reactor or DC Link Choke .....	186
	Connecting a Surge Suppressor .....	187
	Connecting a Noise Filter .....	187
	EMC Filter Installation .....	190
	Zero-Phase Reactor .....	190
	Installing Fuses on the Input Side .....	191
	Attachment for External Heatsink .....	191
	Noise Filter Installation .....	191
	Installing a Motor Thermal Overload (oL) Relay on the Drive Output .....	191
	NEMA Type 1 Kit .....	193
<b>7.5</b>	<b>Options</b> .....	<b>198</b>
	Interface Options .....	198
	Other Options .....	198
<b>A.</b>	<b>SPECIFICATIONS</b> .....	<b>199</b>
<b>A.1</b>	<b>Heavy Duty and Normal Duty Ratings</b> .....	<b>200</b>

<b>A.2</b>	<b>Single/Three-Phase 200 V Class Drives</b> .....	<b>201</b>
<b>A.3</b>	<b>Three-Phase 400 V Class Drives</b> .....	<b>203</b>
<b>A.4</b>	<b>Drive Specifications</b> .....	<b>205</b>
<b>A.5</b>	<b>Drive Watt Loss Data</b> .....	<b>209</b>
<b>A.6</b>	<b>Drive Derating Data</b> .....	<b>211</b>
	Temperature Derating .....	211
	Altitude Derating .....	212
<b>B.</b>	<b>PARAMETER LIST</b> .....	<b>213</b>
<b>B.1</b>	<b>Parameter Groups</b> .....	<b>214</b>
<b>B.2</b>	<b>Parameter Table</b> .....	<b>215</b>
	A: Initialization Parameters .....	215
	b: Application .....	216
	C: Tuning .....	217
	d: References .....	220
	E: Motor Parameters .....	222
	H Parameters: Multi-Function Terminals .....	223
	L: Protection Function .....	229
	n: Advanced Performance Set-Up .....	233
	o: Operator Related Parameters .....	233
	U: Monitors .....	235
<b>B.3</b>	<b>Defaults by Drive Model and Duty Rating ND/HD</b> .....	<b>238</b>
<b>C.</b>	<b>STANDARDS COMPLIANCE</b> .....	<b>241</b>
<b>C.1</b>	<b>Section Safety</b> .....	<b>242</b>
<b>C.2</b>	<b>European Standards</b> .....	<b>245</b>
	CE Low Voltage Directive Compliance .....	245
	EMC Guidelines Compliance.....	248
<b>C.3</b>	<b>UL Standards</b> .....	<b>254</b>
	UL Standards Compliance .....	254
	Drive Motor Overload Protection .....	260
	<b>INDEX</b> .....	<b>263</b>



# Preface & General Safety

---

This section provides safety messages pertinent to this product that, if not heeded, may result in fatality, personal injury, or equipment damage. Yaskawa is not responsible for the consequences of ignoring these instructions.

<b>i.1</b>	<b>PREFACE.....</b>	<b>10</b>
<b>i.2</b>	<b>GENERAL SAFETY.....</b>	<b>11</b>

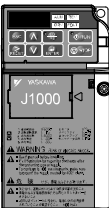
# i.1 Preface

Yaskawa manufactures products used as components in a wide variety of industrial systems and equipment. The selection and application of Yaskawa products remain the responsibility of the equipment manufacturer or end user. Yaskawa accepts no responsibility for the way its products are incorporated into the final system design. Under no circumstances should any Yaskawa product be incorporated into any product or design as the exclusive or sole safety control. Without exception, all controls should be designed to detect faults dynamically and fail safely under all circumstances. All systems or equipment designed to incorporate a product manufactured by Yaskawa must be supplied to the end user with appropriate warnings and instructions as to the safe use and operation of that part. Any warnings provided by Yaskawa must be promptly provided to the end user. Yaskawa offers an express warranty only as to the quality of its products in conforming to standards and specifications published in the Yaskawa manual. **NO OTHER WARRANTY, EXPRESS OR IMPLIED, IS OFFERED.** Yaskawa assumes no liability for any personal injury, property damage, losses, or claims arising from misapplication of its products.

---

## ◆ Applicable Documentation

The following manuals are available for J1000 series drives:

	J1000 Series Compact V/f Control Drive Quick Start Guide
	Read this manual first. This guide is packaged together with the product. It contains basic information required to install and wire the drive. This guide provides basic programming and simple setup and adjustment. Refer to the J1000 Technical Manual for complete descriptions of drive features and functions.
	J1000 Series Compact V/f Control Drive Technical Manual
	This manual describes installation, wiring, operation procedures, functions, troubleshooting, maintenance, and inspections to perform before operation.

---

## ◆ Symbols

**Note:** Indicates a supplement or precaution that does not cause drive damage.



Indicates a term or definition used in this manual.

---

## ◆ Terms and Abbreviations

- **Drive:** Yaskawa J1000 Series Drive
- **r/min:** Revolutions per Minute
- **SI-485/J:** RS-422/RS-485 Interface for MEMOBUS/Modbus Communication
- **V/f:** V/f Control

## i.2 General Safety

### ◆ Supplemental Safety Information

#### General Precautions

- The diagrams in this manual may be indicated without covers or safety shields to show details. Restore covers or shields before operating the drive and run the drive according to the instructions described in this manual.
- Any illustrations, photographs, or examples used in this manual are provided as examples only and may not apply to all products to which this manual is applicable.
- The products and specifications described in this manual or the content and presentation of the manual may be changed without notice to improve the product and/or the manual.
- When ordering a new copy of the manual due to damage or loss, contact your Yaskawa representative or the nearest Yaskawa sales office and provide the manual number shown on the front cover.
- If nameplate becomes worn or damaged, order a replacement from your Yaskawa representative or the nearest Yaskawa sales office.

#### WARNING

Read and understand this manual before installing, operating or servicing this drive. The drive must be installed according to this manual and local codes.

The following conventions are used to indicate safety messages in this manual. Failure to heed these messages could result in serious or possibly even fatal injury or damage to the products or to related equipment and systems.

#### DANGER

Indicates a hazardous situation, which, if not avoided, will result in death or serious injury.

#### WARNING

Indicates a hazardous situation, which, if not avoided, could result in death or serious injury.

**WARNING!** *will also be indicated by a bold key word embedded in the text followed by an italicized safety message.*

### CAUTION

Indicates a hazardous situation, which, if not avoided, could result in minor or moderate injury.

**CAUTION!** will also be indicated by a bold key word embedded in the text followed by an italicized safety message.

### NOTICE

Indicates a property damage message.

**NOTICE:** will also be indicated by a bold key word embedded in the text followed by an italicized safety message.

## ◆ Safety Messages

### DANGER

**Heed the safety messages in this manual.**

Failure to comply will result in death or serious injury.

The operating company is responsible for any injuries or equipment damage resulting from failure to heed the warnings in this manual.

#### **Electrical Shock Hazard**

**Do not connect or disconnect wiring while the power is on.**

Failure to comply will result in death or serious injury.

Before servicing, disconnect all power to the equipment. The internal capacitor remains charged even after the power supply is turned off. The charge indicator LED will extinguish when the DC bus voltage is below 50 Vdc. To prevent electric shock, wait at least one minute after all indicators are OFF and measure the DC bus voltage level to confirm safe level.

 **WARNING****Sudden Movement Hazard**

**System may start unexpectedly upon application of power, resulting in death or serious injury.**

Clear all personnel from the drive, motor and machine area before applying power. Secure covers, couplings, shaft keys and machine loads before applying power to the drive.

**Electrical Shock Hazard**

**Do not attempt to modify or alter the drive in any way not explained in this manual.**

Failure to comply could result in death or serious injury.

Yaskawa is not responsible for any modification of the product made by the user. This product must not be modified.

**Do not allow unqualified personnel to use equipment.**

Failure to comply could result in death or serious injury.

Maintenance, inspection, and replacement of parts must be performed only by authorized personnel familiar with installation, adjustment and maintenance of AC drives.

**Do not remove covers or touch circuit boards while the power is on.**

Failure to comply could result in death or serious injury.

**Fire Hazard**

**Do not use an improper voltage source.**

Failure to comply could result in death or serious injury by fire.

Verify that the rated voltage of the drive matches the voltage of the incoming power supply before applying power.

**Crush Hazard**

**Do not use this drive in lifting applications without installing external safety circuitry to prevent accidental dropping of the load.**

**The drive does not possess built-in load drop protection for lifting applications.**

Failure to comply could result in death or serious injury from falling loads.

Install electrical and/or mechanical safety circuit mechanisms independent of drive circuitry.

### CAUTION

#### Crush Hazard

**Do not carry the drive by the front cover.**

Failure to comply may result in minor or moderate injury from the main body of the drive falling.

### NOTICE

**Observe proper electrostatic discharge procedures (ESD) when handling the drive and circuit boards.**

Failure to comply may result in ESD damage to the drive circuitry.

**Never connect or disconnect the motor from the drive while the drive is outputting voltage.**

Improper equipment sequencing could result in damage to the drive.

**Do not perform a withstand voltage test on any part of the drive.**

Failure to comply could result in damage to the sensitive devices within the drive.

**Do not operate damaged equipment.**

Failure to comply could result in further damage to the equipment.

Do not connect or operate any equipment with visible damage or missing parts.

**Install adequate branch circuit short circuit protection per applicable codes.**

Failure to comply could result in damage to the drive.

The drive is suitable for circuits capable of delivering not more than 31,000 RMS symmetrical Amperes, 240 Vac maximum (200 V Class) and 480 Vac maximum (400 V Class).

**Do not expose the drive to halogen group disinfectants.**

Failure to comply may cause damage to the electrical components in the drive.

Do not pack the drive in wooden materials that have been fumigated or sterilized.

Do not sterilize the entire package after the product is packed.

## ◆ Drive Label Warnings

Always heed the warning information listed in *Figure i.1* in the position shown in *Figure i.2*.

**! WARNING Risk of electric shock.**



- Read manual before installing.
- Wait 1 minute for capacitor discharge after disconnecting power supply.
- To conform to **CE** requirements, make sure to ground the supply neutral for 400V class.

Figure i.1 Warning Information

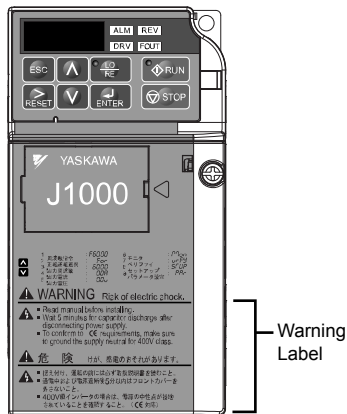


Figure i.2 Warning Information Position

### ◆ Warranty Information

#### ■ Restrictions

The drive was not designed or manufactured for use in devices or systems that may directly affect or threaten human lives or health.

Customers who intend to use the product described in this manual for devices or systems relating to transportation, health care, space aviation, atomic power, electric power, or in underwater applications must first contact their Yaskawa representatives or the nearest Yaskawa sales office.

This product has been manufactured under strict quality-control guidelines. However, if this product is to be installed in any location where failure of this product could involve or result in a life-and-death situation or loss of human life or in a facility where failure may cause a serious accident or physical injury, safety devices must be installed to minimize the likelihood of any accident.

### ◆ Quick Reference

#### Run a Motor of One-Frame Larger Capacity

When using this drive for variable torque loads such as fans and pumps, a motor one frame size larger can be used.

#### Know the Details of Safety Measures

The functions listed below affect the safe operation of the drive. Ensure that the settings fit the application requirements prior to operation.

**Safe operations.** Run by power on. Parameter setting b1-17.

**LED operator stop key priority selection.** Parameter o2-02.

**Enter press required after changing the keypad frequency reference.** Parameter o2-05.

**Operation interlock when program mode is selected.** Parameter b1-08.

#### Standards Compliance

*Refer to European Standards on page 245 and Refer to UL Standards on page 254.*





## Receiving

---

This chapter describes the proper inspections to perform after receiving the drive and illustrates the different enclosure types and components.

<b>1.1</b>	<b>SECTION SAFETY.....</b>	<b>18</b>
<b>1.2</b>	<b>MODEL NUMBER AND NAMEPLATE CHECK... </b>	<b>19</b>
<b>1.3</b>	<b>COMPONENT NAMES.....</b>	<b>22</b>

# 1.1 Section Safety

### CAUTION

**Do not carry the drive by the front cover.**

Failure to comply may cause the main body of the drive to fall, resulting in minor or moderate injury.

### NOTICE

**Observe proper electrostatic discharge procedures (ESD) when handling the drive and circuit boards.**

Failure to comply may result in ESD damage to the drive circuitry.

**A motor connected to a PWM drive may operate at a higher temperature than a utility-fed motor and the operating speed range may reduce motor cooling capacity.**

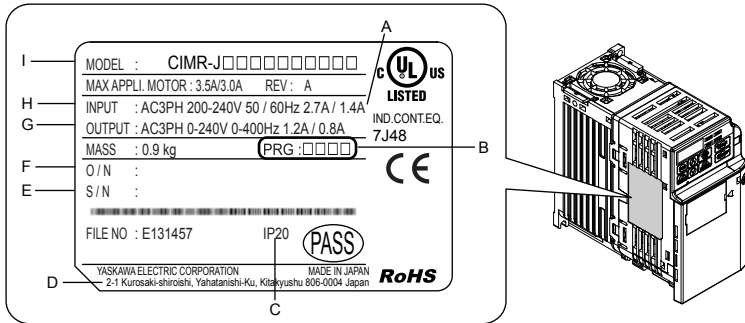
Ensure that the motor is suitable for drive duty and/or the motor service factor is adequate to accommodate the additional heating with the intended operating conditions.

## 1.2 Model Number and Nameplate Check

Please perform the following tasks after receiving the drive:

- Inspect the drive for damage.  
If the drive appears damaged upon receipt, contact the shipper immediately.
- Verify receipt of the correct model by checking the information on the nameplate.
- If you have received the wrong model or the drive does not function properly, contact your supplier.

### ◆ Nameplate

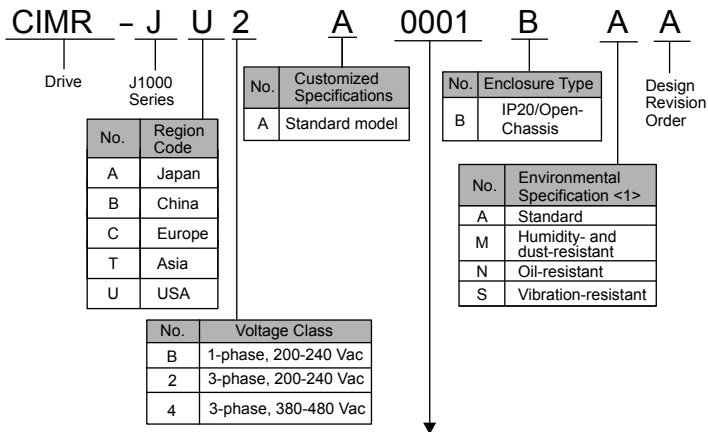


- |   |                                  |
|---|----------------------------------|
| <b>A</b> – Normal Duty Amps / Heavy Duty Amps | <b>F</b> – Lot number            |
| <b>B</b> – Software version                   | <b>G</b> – Output specifications |
| <b>C</b> – Enclosure type                     | <b>H</b> – Input specifications  |
| <b>D</b> – Address <1>                        | <b>I</b> – AC drive model        |
| <b>E</b> – Serial number                      |                                  |

Figure 1.1 Nameplate Information Example

- <1> The address of the head office of Yaskawa Electric Corporation (responsible for product liability) is shown on the nameplate.

## 1.2 Model Number and Nameplate Check



Refer to the tables below.

### ■ Single-Phase 200 V

Normal Duty			Heavy Duty		
No.	Max. Motor Capacity kW	Rated Output Current A	No.	Max. Motor Capacity kW	Rated Output Current A
0001	0.2	1.2	0001	0.1	0.8
0002	0.4	1.9	0002	0.2	1.6
0003	0.75	3.3	0003	0.4	3.0
0006	1.1	6.0	0006	0.75	5.0
0010	2.2	9.6	0010	1.5	8.0

### ■ Three-Phase 200 V

Normal Duty			Heavy Duty		
No.	Max Motor Capacity kW	Rated Output Current A	No.	Max Motor Capacity kW	Rated Output Current A
0001	0.2	1.2	0001	0.1	0.8
0002	0.4	1.9	0002	0.2	1.6
0004	0.75	3.5	0004	0.4	3.5
0006	1.1	6.0	0006	0.75	6.0
0010	2.2	9.6	0010	1.5	9.6
0012	3.0	12.0	0012	2.2	12.0
0020	5.5	19.6	0020	3.7	17.5

## 1.2 Model Number and Nameplate Check

### ■ Three-Phase 400 V

Normal Duty			Heavy Duty		
No.	Max. Motor Capacity kW	Rated Output Current A	No.	Max. Motor Capacity kW	Rated Output Current A
0001	0.4	1.2	0001	0.2	1.2
0002	0.75	2.1	0002	0.4	1.8
0004	1.5	4.1	0004	0.75	3.4
0005	2.2	5.4	0005	1.5	4.8
0007	3.0	6.9	0007	2.2	5.5
0009	3.7	8.8	0009	3.0	7.2
0011	5.5	11.1	0011	3.7	9.2

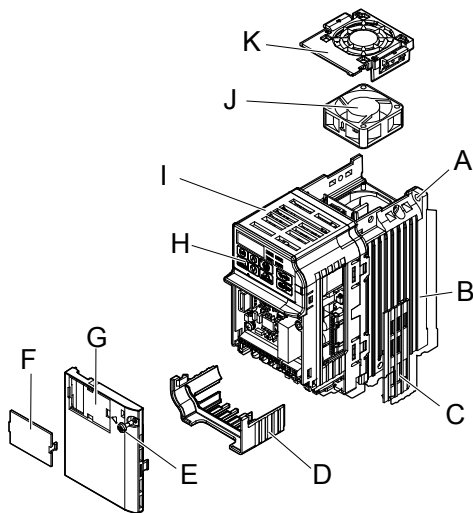
# 1.3 Component Names

This section illustrates drive components in the IP20/Open-Chassis models.

*Refer to NEMA Type 1 Kit on page 193* for information on using the NEMA Type 1 Kit option to create a NEMA Type 1 rating.

### ◆ IP20/Open-Chassis

- Single-Phase AC 200 V BA0001B to BA0003B
- Three-Phase AC 200 V 2A0001B to 2A0006B

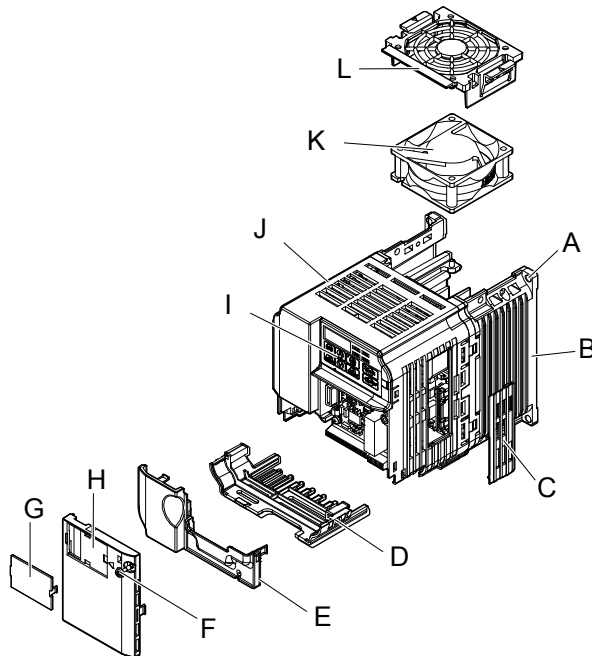


- |                            |  |
|----------------------------|--|
| A – Mounting hole          | G – Front cover  |
| B – Heatsink               | H – LED operator <i>Refer to Using the Digital LED Operator on page 73</i> |
| C – Cable cover            | I – Case   |
| D – Terminal cover         | J – Cooling fan <1>  |
| E – Front cover screw      | K – Fan cover <1>  |
| F – Option connector cover |  |

Figure 1.2 Exploded View of IP20/Open-Chassis Type Components (Model 2A0006B)

<1> Models BA0001B to BA0003B and 2A0001B to 2A0004B do not have a cooling fan or a cooling fan cover.

- Single-Phase AC 200 V BA0006B to BA0010B
- Three-Phase AC 200 V 2A0010B to 4A0020B
- Three-Phase AC 400 V 4A0001B to 4A0011B



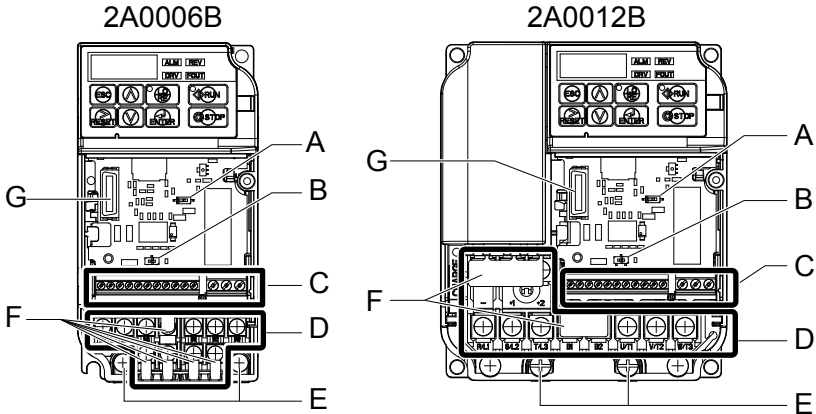
- |                       |  |
|-----------------------|--|
| A – Mounting hole     | G – Option connector cover   |
| B – Heatsink          | H – Front cover  |
| C – Cable cover       | I – LED operator <i>Refer to Using the Digital LED Operator on page 73</i> |
| D – Terminal cover    | J – Case   |
| E – Bottom cover      | K – Cooling fan <1>  |
| F – Front cover screw | L – Fan cover <1>  |

**Figure 1.3 Exploded view of IP20/Open-Chassis Type Components (Model 2A0012B)**

<1> Models BA0006B and 4A0001B to 4A0004B do not have a cooling fan or a cooling fan cover.

### 1.3 Component Names

#### ◆ Front Views



- A – DIP switch S1 Refer to [DIP Switch S1 Analog Input Signal Selection on page 62](#)
- B – DIP switch S3 Refer to [Sinking/Sourcing Mode Switch on page 59](#)
- C – Control circuit terminal Refer to [Control Circuit Wiring on page 52](#)
- D – Main circuit terminal Refer to [Wiring the Main Circuit Terminal on page 51](#)
- E – Ground terminal
- F – Terminal cover
- G – Option unit connector Refer to [Options on page 198](#)

Figure 1.4 Front Views of Drives



# 2

## Mechanical Installation

---

This chapter explains how to properly mount and install the drive.

<b>2.1</b>	<b>SECTION SAFETY.....</b>	<b>26</b>
<b>2.2</b>	<b>MECHANICAL INSTALLATION.....</b>	<b>29</b>

## 2.1 Section Safety

### **WARNING**

#### **Fire Hazard**

**Provide sufficient cooling with a fan or air conditioning unit when installing the drive inside an enclosed panel or cabinet.**

Failure to comply could result in overheating and fire.

The airflow over an IP20/Open-Chassis drive should be less than 50 °C, while an IP20/NEMA Type 1 drive using the NEMA Type 1 Kit option should have an airflow cooler than 40 °C.

### **CAUTION**

#### **Crush Hazard**

**Do not carry the drive by the front cover.**

Failure to comply may result in minor or moderate injury from the main body of the drive falling.

**NOTICE**

**Observe proper electrostatic discharge (ESD) procedures when handling the drive.**

Failure to comply could result in ESD damage to the drive circuitry.

**It may be difficult to perform maintenance on the cooling fans of drives installed in a vertical row inside an enclosure.**

Ensure adequate spacing at the top of the drive to perform cooling fan replacement when required.

**Operating the motor in the low-speed range diminishes the cooling effects, increases motor temperature, and may lead to motor damage by overheating.**

Reduce the motor torque in the low-speed range whenever using a standard blower cooled motor. If 100% torque is required continuously at low speed, consider using a special drive or vector motor. Select a motor that is compatible with the required load torque and operating speed range.

**Do not operate motors above the maximum rated RPM.**

Failure to comply may lead to bearing or other mechanical motor failures.

**The speed range for continuous operation differs according to the lubrication method and motor manufacturer.**

If the motor is to be operated at a speed higher than the rated speed, consult with the manufacturer.

Continuously operating an oil-lubricated motor in the low-speed range may result in burning.

### NOTICE

**When the wiring distance is greater than 100 meters, pay special attention to the motor insulation voltage or use a drive-rated motor.**

Failure to comply could lead to motor winding failure.

**Motor vibration may increase when operating a machine in variable-speed mode, if that machine previously operated at a constant speed.**

Install vibration-proof rubber on the motor base or use the frequency jump function to skip a frequency resonating the machine.

**The motor may require more acceleration torque with drive operation than with a commercial power supply.**

Set a proper V/f pattern by checking the load torque characteristics of the machine to be used with the motor.

**The rated input current of submersible motors is higher than the rated input current of standard motors.**

Select an appropriate drive according to its rated output current. When the distance between the motor and drive is long, use a cable thick enough to connect the motor to the drive to prevent motor torque reduction.

**When using an explosion-proof motor, it must be subject to an explosion-proof test in conjunction with the drive.**

This is also applicable when an existing explosion-proof motor is to be operated with the drive. Since the drive itself is not explosion-proof, always install it in a safe place.

**Do not use a drive for a single-phase motor.**

Replace the motor with a three-phase motor.

**If an oil-lubricated gearbox or speed reducer is used in the power transmission mechanism, oil lubrication will be affected when the motor operates only in the low speed range.**

The power transmission mechanism will make noise and experience problems with service life and durability if the motor is operated at a speed higher than the rated speed.

## 2.2 Mechanical Installation

This section outlines specifications, procedures, and environment for proper mechanical installation of the drive.

### ◆ Installation Environment

To help prolong the optimum performance life of the drive, install the drive in the proper environment. The table below provides a description of the appropriate environment for the drive.

**Table 2.1 Installation Environment**

Environment	Conditions
<b>Installation Area</b>	Indoors
<b>Ambient Temperature</b>	IP20/NEMA Type 1 enclosure: -10 °C to +40 °C (14 °F to 104 °F) IP20/IP00 Open-Chassis enclosure: -10 °C to +50 °C (14 °F to 122 °F) Finless Type: IP20 enclosure: -10 °C to +50 °C (14 °F to 122 °F) Drive reliability improves in environments without wide temperature fluctuations. When using an enclosure panel, install a cooling fan or air conditioner in the area to ensure that the air temperature inside the enclosure does not exceed the specified levels. Do not allow ice to develop on the drive.
<b>Humidity</b>	95% RH or less and free of condensation
<b>Storage Temperature</b>	-20 °C to +60 °C (-4 °F to +104 °F)
<b>Surrounding Area</b>	Install the drive in an area free from: <ul style="list-style-type: none"> <li>• oil mist and dust</li> <li>• metal shavings, oil, water or other foreign materials</li> <li>• radioactive materials</li> <li>• combustible materials (e.g., wood)</li> <li>• harmful gases and liquids</li> <li>• excessive vibration</li> <li>• chlorides</li> <li>• direct sunlight</li> </ul>
<b>Altitude</b>	Up to 1000 meters without derating; up to 3000 meters with output current, ambient temperature, and voltage derating.
<b>Vibration</b>	10 to 20 Hz at 9.8 m/s <sup>2</sup> 20 to 55 Hz at 5.9 m/s <sup>2</sup>
<b>Orientation</b>	Install the drive vertically to maintain maximum cooling effects.

**NOTICE:** Prevent foreign matter such as metal shavings or wire clippings from falling into the drive during installation and project construction. Failure to comply could result in damage to the drive. Place a temporary cover over the top of the drive during installation. Remove the temporary cover before startup, as the cover will reduce ventilation and cause the drive to overheat.

**NOTICE:** Avoid placing drive peripheral devices, transformers, or other electronics near the drive. Failure to comply could result in erroneous operation. If such devices must be used in close proximity to the drive, take proper steps to shield the drive from noise.

## 2.2 Mechanical Installation

### ◆ Installation Orientation and Spacing

Install the drive upright as illustrated in [Figure 2.1](#) to maintain proper cooling.

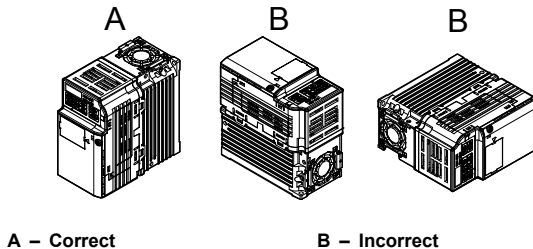


Figure 2.1 Correct Installation Orientation

### ■ Single Drive Installation

[Figure 2.2](#) explains the required installation spacing to maintain sufficient space for airflow and wiring. Install the heatsink against a closed surface to avoid diverting cooling air around the heatsink.

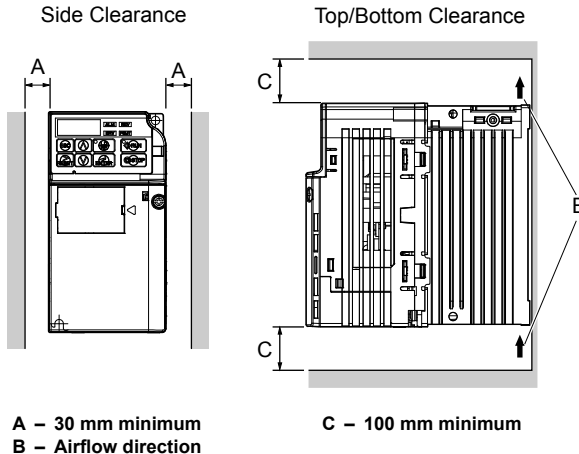
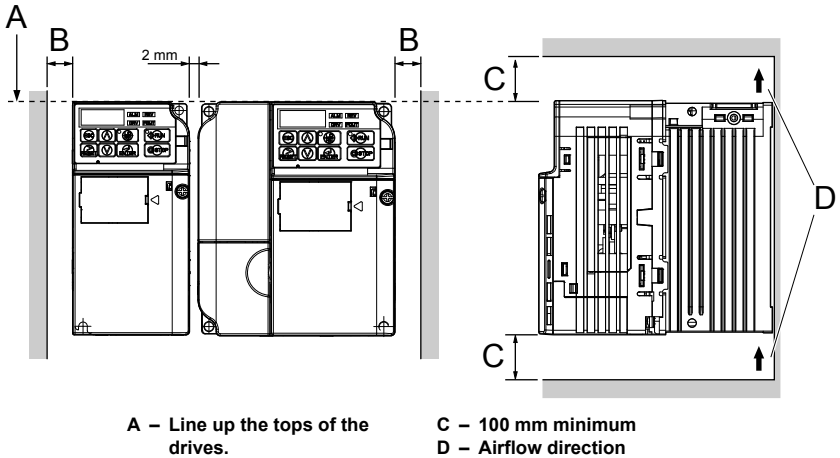


Figure 2.2 Correct Installation Spacing

**Note:** The space required on the left and right sides of the drive are the same for IP20/Open-Chassis drives and IP20/NEMA Type 1 drives using the NEMA Type 1 Kit option.

### Multiple Drive Installation

When installing multiple drives into the same enclosure panel, mount the drives according to [Figure 2.2](#). When mounting drives with a minimum side-by-side clearance of 2 mm according to [Figure 2.3](#), derating must be considered and parameter L8-35 must be set. [Refer to Parameter List on page 213](#).



A – Line up the tops of the drives.

B – 30 mm minimum

C – 100 mm minimum

D – Airflow direction

Figure 2.3 Space Between Drives (Side-by-Side Mounting)

**Note:** When installing drives of different heights in the same enclosure panel, the tops of the drives should line up. Leave space between the top and bottom of stacked drives for cooling fan replacement if required. Using this method, it is possible to replace the cooling fans later.

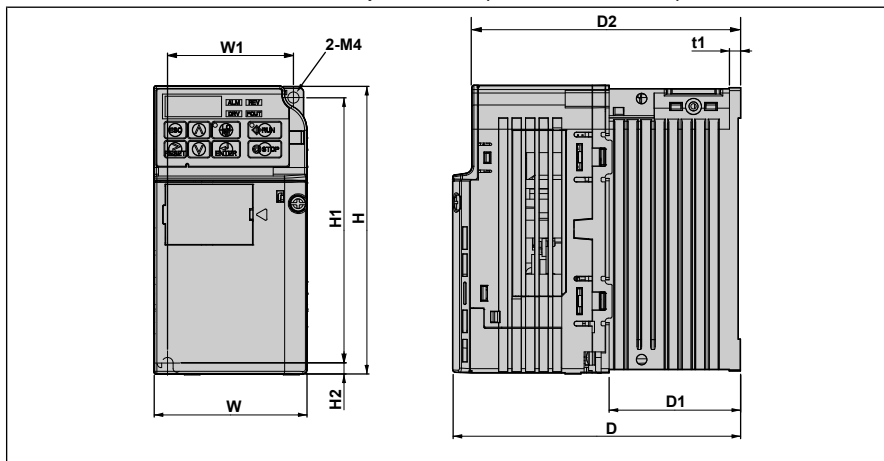
## 2.2 Mechanical Installation

### ◆ Exterior and Mounting Dimensions

Refer to *NEMA Type 1 Kit on page 193* for exterior and mounting dimensions for drives using the NEMA Type 1 Kit option.

#### ■ IP20/Open-Chassis Drives

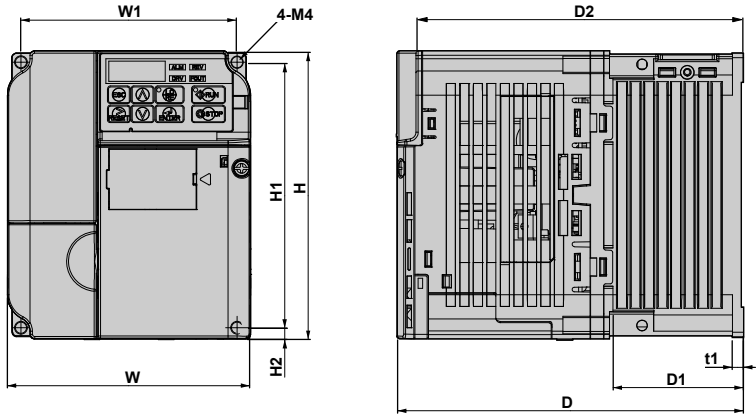
Table 2.2 IP20/Open-Chassis (without an EMC filter)



Voltage Class	Drive Model	Dimensions mm (in)									
		W	H	D	W1	H1	H2	D1	D2	t1	Wt. kg (lb.)
Single-Phase 200 V Class	BA0001B	68 (2.7)	128 (5.0)	76 (3.0)	56 (2.2)	118 (4.6)	5 (0.2)	6.5 (0.3)	67.5 (2.7)	3 (0.1)	0.6 (1.3)
	BA0002B	68 (2.7)	128 (5.0)	76 (3.0)	56 (2.2)	118 (4.6)	5 (0.2)	6.5 (0.3)	67.5 (2.7)	3 (0.1)	0.6 (1.3)
	BA0003B	68 (2.7)	128 (5.0)	118 (4.6)	56 (2.2)	118 (4.6)	5 (0.2)	38.5 (1.5)	109.5 (4.3)	5 (0.2)	1.0 (2.2)
Three-Phase 200 V Class	2A0001B	68 (2.7)	128 (5.0)	76 (3.0)	56 (2.2)	118 (4.6)	5 (0.2)	6.5 (0.3)	67.5 (2.7)	3 (0.1)	0.6 (1.3)
	2A0002B	68 (2.7)	128 (5.0)	76 (3.0)	56 (2.2)	118 (4.6)	5 (0.2)	6.5 (0.3)	67.5 (2.7)	3 (0.1)	0.6 (1.3)
	2A0004B	68 (2.7)	128 (5.0)	108 (4.3)	56 (2.2)	118 (4.6)	5 (0.2)	38.5 (1.5)	99.5 (3.9)	5 (0.2)	0.9 (2.0)
	2A0006B	68 (2.7)	128 (5.0)	128 (5.0)	56 (2.2)	118 (4.6)	5 (0.2)	58.5 (2.3)	119.5 (4.7)	5 (0.2)	1.1 (2.4)

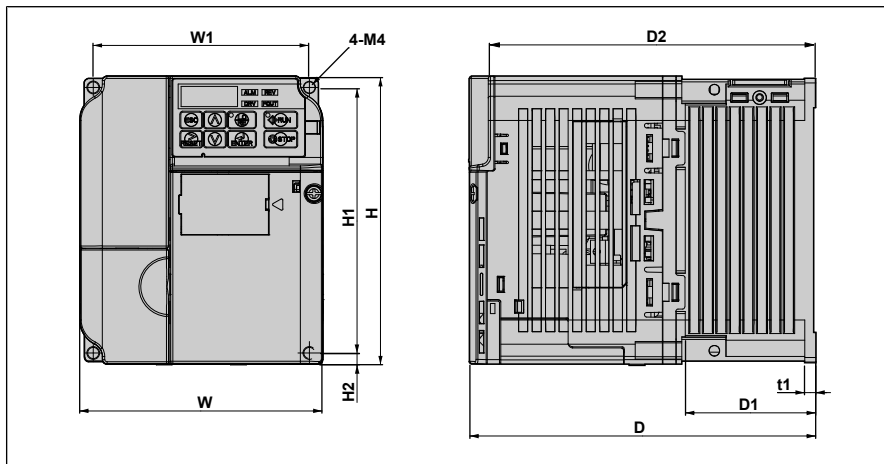


Table 2.3 IP20/Open-Chassis (without an EMC filter)



Voltage Class	Drive Model	Dimensions mm (in)									Wt. kg (lb.)
		W	H	D	W1	H1	H2	D1	D2	t1	
Single-Phase 200 V Class	BA0006B	108 (4.3)	128 (5.0)	137.5 (5.4)	96 (3.8)	118 (4.6)	5 (0.2)	58 (2.3)	129 (5.1)	5 (0.2)	1.7 (3.8)
	BA0010B	108 (4.3)	128 (5.0)	154 (6.1)	96 (3.8)	118 (4.6)	5 (0.2)	58 (2.3)	145.5 (5.7)	5 (0.2)	1.8 (4.0)
Three-Phase 200 V Class	2A0010B	108 (4.3)	128 (5.0)	129 (5.1)	96 (3.8)	118 (4.6)	5 (0.2)	58 (2.3)	120.5 (4.7)	5 (0.2)	1.7 (3.8)
	2A0012B	108 (4.3)	128 (5.0)	137.5 (5.4)	96 (3.8)	118 (4.6)	5 (0.2)	58 (2.3)	129 (5.1)	5 (0.2)	1.7 (3.8)
	2A0020B	140 (5.5)	128 (5.0)	143 (5.6)	128 (5.0)	118 (4.6)	5 (0.2)	65 (2.6)	134.5 (5.3)	5 (0.2)	2.4 (5.3)

## 2.2 Mechanical Installation



Voltage Class	Drive Model	Dimensions mm (in)									
		W	H	D	W1	H1	H2	D1	D2	t1	Wt. kg (lb.)
Three-Phase 400 V Class	4A0001B	108 (4.3)	128 (5.0)	81 (3.2)	96 (3.8)	118 (4.6)	5 (0.2)	10 (0.4)	72.5 (2.9)	5 (0.2)	1.0 (2.2)
	4A0002B	108 (4.3)	128 (5.0)	99 (3.9)	96 (3.8)	118 (4.6)	5 (0.2)	28 (1.1)	90.5 (3.6)	5 (0.2)	1.2 (2.7)
	4A0004B	108 (4.3)	128 (5.0)	137.5 (5.4)	96 (3.8)	118 (4.6)	5 (0.2)	58 (2.3)	129 (5.1)	5 (0.2)	1.7 (3.8)
	4A0005B	108 (4.3)	128 (5.0)	154 (6.1)	96 (3.8)	118 (4.6)	5 (0.2)	58 (2.3)	145.5 (5.7)	5 (0.2)	1.7 (3.8)
	4A0007B	108 (4.3)	128 (5.0)	154 (6.1)	96 (3.8)	118 (4.6)	5 (0.2)	58 (2.3)	145.5 (5.7)	5 (0.2)	1.7 (3.8)
	4A0009B	108 (4.3)	128 (5.0)	154 (6.1)	96 (3.8)	118 (4.6)	5 (0.2)	58 (2.3)	145.5 (5.7)	5 (0.2)	1.7 (3.8)
	4A0011B	140 (5.5)	128 (5.0)	143 (5.6)	128 (5.0)	118 (4.6)	5 (0.2)	65 (2.6)	134.5 (5.3)	5 (0.2)	2.4 (5.3)

# 3

## Electrical Installation

---

This chapter explains proper procedures for wiring the control circuit terminals, motor and power supply.

<b>3.1</b>	<b>SECTION SAFETY.....</b>	<b>36</b>
<b>3.2</b>	<b>STANDARD CONNECTION DIAGRAM.....</b>	<b>39</b>
<b>3.3</b>	<b>MAIN CIRCUIT CONNECTION DIAGRAM.....</b>	<b>42</b>
<b>3.4</b>	<b>TERMINAL BLOCK CONFIGURATION.....</b>	<b>43</b>
<b>3.5</b>	<b>PROTECTIVE COVERS.....</b>	<b>44</b>
<b>3.6</b>	<b>MAIN CIRCUIT WIRING.....</b>	<b>46</b>
<b>3.7</b>	<b>CONTROL CIRCUIT WIRING.....</b>	<b>52</b>
<b>3.8</b>	<b>I/O CONNECTIONS.....</b>	<b>59</b>
<b>3.9</b>	<b>MAIN FREQUENCY REFERENCE.....</b>	<b>62</b>
<b>3.10</b>	<b>BRAKING RESISTOR.....</b>	<b>64</b>
<b>3.11</b>	<b>INTERLOCKING WITH CONNECTED MACHINERY.....</b>	<b>66</b>
<b>3.12</b>	<b>WIRING CHECKLIST.....</b>	<b>67</b>

### 3.1 Section Safety

#### DANGER

##### **Electrical Shock Hazard**

**Do not connect or disconnect wiring while the power is on.**

Failure to comply will result in death or serious injury.

#### WARNING

##### **Electrical Shock Hazard**

**Do not operate equipment with covers removed.**

Failure to comply could result in death or serious injury.

The diagrams in this section may show drives without covers or safety shields to show details. Be sure to reinstall covers or shields before operating the drives and run the drives according to the instructions described in this manual.

**Always ground the motor-side grounding terminal.**

Improper equipment grounding could result in death or serious injury by contacting the motor case.

**Do not perform work on the drive while wearing loose clothing, jewelry or without eye protection.**

Failure to comply could result in death or serious injury.

Remove all metal objects such as watches and rings, secure loose clothing, and wear eye protection before beginning work on the drive.

**Do not remove covers or touch circuit boards while the power is on.**

Failure to comply could result in death or serious injury.

**Do not allow unqualified personnel to perform work on the drive.**

Failure to comply could result in death or serious injury.

Installation, maintenance, inspection, and servicing must be performed only by authorized personnel familiar with installation, adjustment, and maintenance of AC drives.

 **WARNING****Do not touch any terminals before the capacitors have fully discharged.**

Failure to comply could result in death or serious injury.

Before wiring terminals, disconnect all power to the equipment. The internal capacitor remains charged even after the power supply is turned off. The charge indicator LED will extinguish when the DC bus voltage is below 50 Vdc. To prevent electric shock, wait at least one minute after all indicators are off and measure the DC bus voltage level to confirm safe level.

**Fire Hazard****Tighten all terminal screws to the specified tightening torque.**

Loose electrical connections could result in death or serious injury by fire due to overheating of electrical connections.

**Do not use improper combustible materials.**

Failure to comply could result in death or serious injury by fire.

Attach the drive to metal or other noncombustible material.

**Do not use an improper voltage source.**

Failure to comply could result in death or serious injury by fire.

Verify that the rated voltage of the drive matches the voltage of the incoming power supply before applying power.

#### NOTICE

**Observe proper electrostatic discharge procedures (ESD) when handling the drive and circuit boards.**

Failure to comply may result in ESD damage to the drive circuitry.

**Never connect or disconnect the motor from the drive while the drive is outputting voltage.**

Improper equipment sequencing could result in damage to the drive.

**Do not use unshielded cable for control wiring.**

Failure to comply may cause electrical interference resulting in poor system performance. Use shielded, twisted-pair wires and ground the shield to the ground terminal of the drive.

**Check all the wiring to ensure that all connections are correct after installing the drive and connecting any other devices.**

Failure to comply could result in damage to the drive.

**Do not modify the drive circuitry.**

Failure to comply could result in damage to the drive and will void warranty.

Yaskawa is not responsible for any modification of the product made by the user. This product must not be modified.

**Route motor leads U/T1, V/T2, and W/T3 separate from other leads to reduce possible interference-related issues.**

Failure to comply may result in abnormal operation of drive and nearby equipment.

## 3.2 Standard Connection Diagram

Connect the drive and peripheral devices as shown in *Figure 3*. It is possible to run the drive via the digital operator without connecting digital I/O wiring. This section does not discuss drive operation; *Refer to Start-Up Programming & Operation on page 69* for instructions on operating the drive.

**NOTICE:** *Inadequate branch short circuit protection could result in damage to the drive. Install adequate branch circuit short circuit protection per applicable codes. The drive is suitable for circuits capable of delivering not more than 31,000 RMS symmetrical amperes, 240 Vac maximum (200 V Class) and 480 Vac maximum (400 V Class).*

**NOTICE:** *When the wiring distance is greater than 100 meters, pay special attention to the motor insulation voltage or use a drive duty motor. Failure to comply could lead to motor insulation breakdown.*

**NOTICE:** *Correctly set Sink/Source jumper S3 for internal power supply. Failure to comply may result in damage to the drive. Refer to I/O Connections on page 59 for details.*

**NOTICE:** *Do not connect AC control circuit ground to drive enclosure. Improper drive grounding can cause control circuit malfunction.*

**NOTICE:** *Route motor leads U/T1, V/T2, and W/T3 separate from all other leads to reduce possible interference related issues. Failure to comply may result in abnormal operation of drive and nearby equipment.*

**NOTICE:** *The minimum load for the multi-function relay output MA-MB-MC is 10 mA.*

## 3.2 Standard Connection Diagram

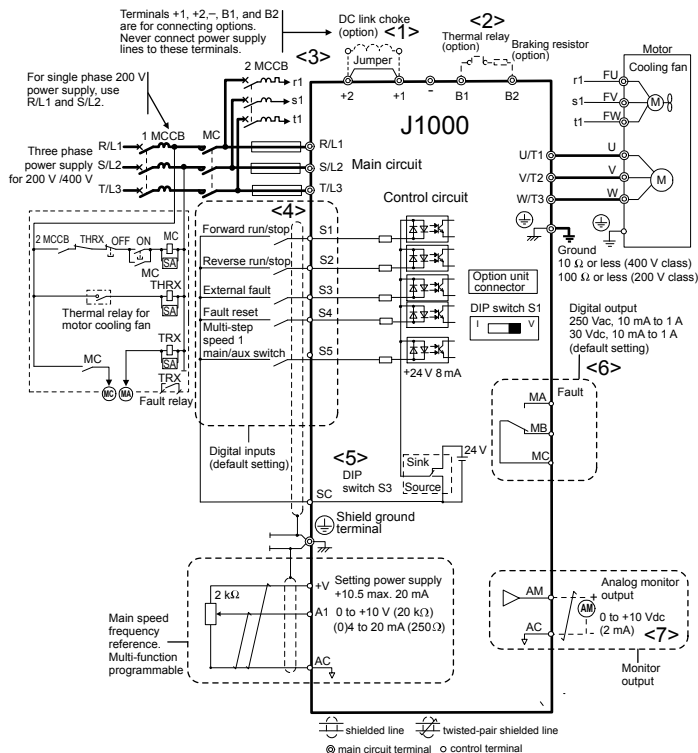


Figure 3.1 Drive Standard Connection Diagram (200 V Class Example)

- <1> Remove the jumper when installing an optional DC link choke.
- <2> The MC on the input side of the main circuit should open when the thermal relay is triggered.
- <3> Self-cooled motors do not require separate cooling fan motor wiring.
- <4> Connected using sequence input signal (S1 to S5) from NPN transistor; Default: sink mode (0 V com).
- <5> Use only a +24 V internal power supply in sinking mode; the source mode requires an external power supply. *Refer to I/O Connections on page 59.*
- <6> Minimum load: 5 Vdc, 10 mA (reference value).



## 3.2 Standard Connection Diagram

<7> Monitor outputs work with devices such as analog frequency meters, ammeters, voltmeters and wattmeters; they are not intended for use as a feedback-type of signal.

**WARNING!** Sudden Movement Hazard. Do not close the wiring for the control circuit unless the multifunction input terminal parameter is properly set (S5 for 3-Wire; H1-05 = "0"). Improper sequencing of run/stop circuitry could result in death or serious injury from moving equipment.

**WARNING!** Sudden Movement Hazard. Ensure start/stop and safety circuits are wired properly and in the correct state before energizing the drive. Failure to comply could result in death or serious injury from moving equipment. When programmed for 3-Wire control, a momentary closure on terminal S1 may cause the drive to start.

**WARNING!** When 3-Wire sequence is used, set the drive to 3-Wire sequence before wiring the control terminals and ensure parameter b1-17 is set to 0 (drive does not accept a run command at power up (default)). If the drive is wired for 3-Wire sequence but set up for 2-Wire sequence (default) and if parameter b1-17 is set to 1 (drive accepts a Run command at power up), the motor will rotate in reverse direction at power up of the drive and may cause injury.

Figure 3.2 illustrates an example of a 3-Wire sequence.

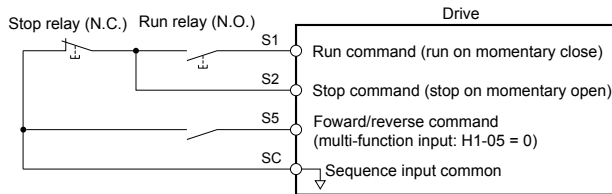


Figure 3.2 3-Wire Sequence

## 3.3 Main Circuit Connection Diagram

Refer to diagrams in this section for the Main Circuit wiring connections. Connections may vary based on drive capacity. The main circuit DC power supply powers the control circuit.

**NOTICE:** Do not use the negative DC bus terminal “-” as a ground terminal. This terminal is at high voltage DC potential. Improper wiring connections could result in damage to the drive.

### ◆ Single-Phase 200 V Class Models BA0001 to BA0010

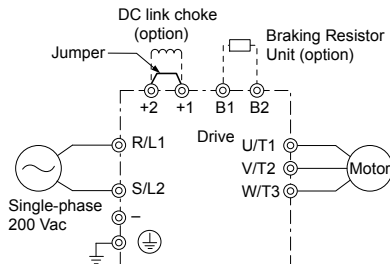


Figure 3.3 Connecting Single-Phase Main Circuit Terminals

**NOTICE:** Do not connect T/L3 terminal when using single-phase power supply input. Incorrect wiring may damage the drive.

### ◆ Three-Phase 200 V Class Models 2A0001 to 2A0020 Three-Phase 400 V Class Models 4A0001 to 4A0011

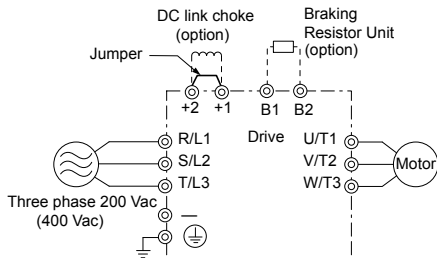


Figure 3.4 Connecting Three-Phase Main Circuit Terminals

## 3.4 Terminal Block Configuration

The figures in this section provide illustrations of the main circuit terminal block configurations of the different drive sizes.

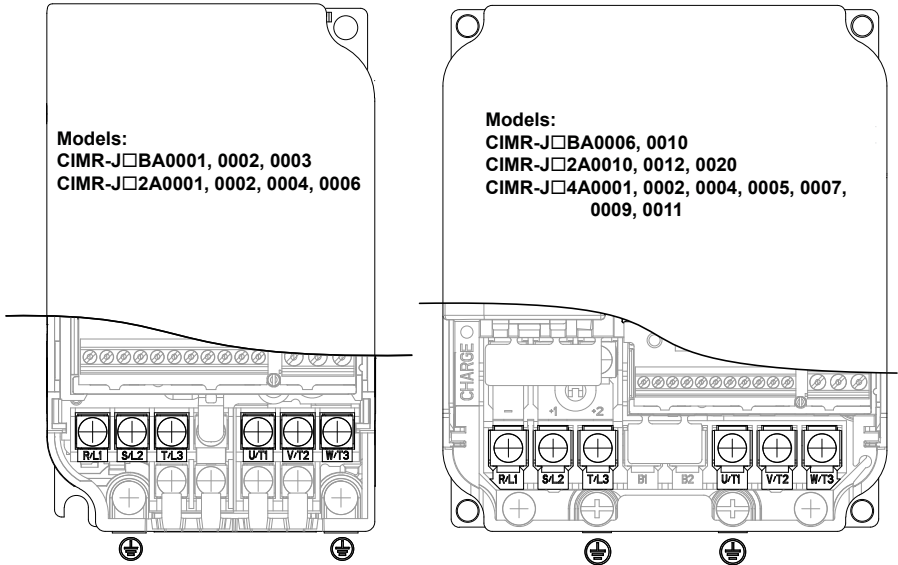


Figure 3.5 Main Circuit Terminal Block Configurations

# 3.5 Protective Covers

Follow the procedure below to remove the protective covers before wiring the drive and to reattach the covers after wiring is complete.

## ◆ IP20/Open-Chassis Cover Removal and Installation

### ■ Removing the Protective Covers

1. Loosen the screw that locks the front cover in place to remove.

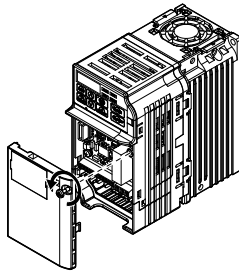


Figure 3.6 Remove the Front Cover on an IP20/Open-Chassis Drive

2. Apply pressure to the tabs on each side of the terminal cover. Pull the terminal cover away from the drive while pushing in on the tabs to pull the cover free.

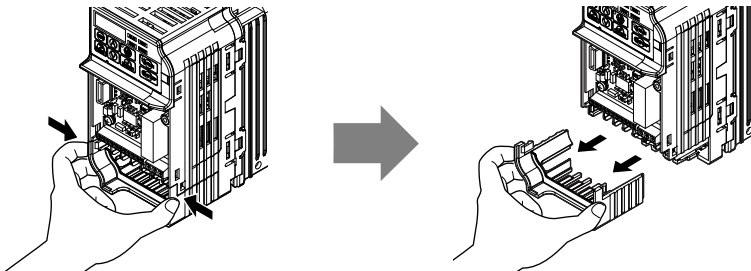


Figure 3.7 Remove the Terminal Cover on an IP20/Open-Chassis Drive

### ■ Reattaching the Protective Covers

Properly connect all wiring and route power wiring away from control signal wiring. Reattach all protective covers when wiring is complete. Apply only a small amount of pressure to lock the cover back into place.

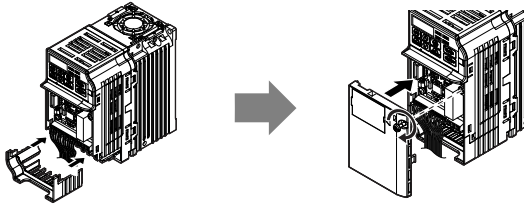


Figure 3.8 Reattach the Protective Covers on an IP20/Open-Chassis Drive

# 3.6 Main Circuit Wiring

This section describes the functions, specifications, and procedures required to safely and properly wire the main circuit of the drive.

**NOTICE:** Do not solder the ends of wire connections to the drive. Soldered wiring connections can loosen over time. Improper wiring practices could result in drive malfunction due to loose terminal connections.

## ◆ Main Circuit Terminal Functions

**Table 3.1 Main Circuit Terminal Functions**

Terminal	Type	Function	Reference
R/L1	Main circuit power supply input	Connects line power to the drive. Drives with single-phase 200 V input power use terminals R/L1 and S/L2 only. Do NOT use T/L3.	-
S/L2			
T/L3			
U/T1	Drive output	Connects to the motor.	49
V/T2			
W/T3			
B1	Braking resistor	Available for connecting a braking resistor or the braking resistor unit option.	-
B2			
⊕1	DC link choke connection	These terminals are shorted at shipment. Remove the shorting bar between ⊕1 and ⊕2 when connecting a DC link choke to this terminal.	-
⊕2			
⊕1	DC power supply input	For connecting a DC power supply.	-
⊖			
⊕ (2 terminals)	Ground	Grounding Terminal	49

## ◆ Wire Gauges and Tightening Torques

Select the appropriate wires and crimp terminals from [Table 3.2](#) through [Table 3.4](#).

- Note:**
1. Wire gauge recommendations based on drive continuous current ratings using 75 °C 600 Vac vinyl-sheathed wire assuming ambient temperature within 30 °C and wiring distance shorter than 100 m.
  2. Terminals ⊕1, ⊕2, ⊖, B1 and B2 are for connecting optional devices such as a braking resistor. Do not connect other non-specified devices to these terminals.
- Consider the amount of voltage drop when selecting wire gauges. Increase the wire gauge when the voltage drop is greater than 2% of motor rated voltage. Ensure the wire gauge is suitable for the terminal block. Use the following formula to calculate the amount of voltage drop:
  - Line drop voltage (V) =  $\sqrt{3}$  x wire resistance (Ω/km) x wire length (m) x current (A) x 10<sup>-3</sup>
  - Refer to instruction manual TOBP C720600 00 for braking unit or braking resistor unit wire gauges.

- *Refer to UL Standards Compliance on page 254* for information on UL compliance.

### ■ Single-Phase 200 V Class

**Table 3.2 Wire Gauge and Torque Specifications**

Drive Model	Terminal	Recomm. Gauge AWG, kcmil	Wire Range AWG, kcmil	Screw Size	Tightening Torque N·m (lb.in.)
BA0001 BA0002 BA0003	R/L1, S/L2, T/L3	14	18 to 14	M3.5	0.8 to 1.0 (7.1 to 8.9)
	U/T1, V/T2, W/T3	14	18 to 14		
	ϕ, ϕ1, ϕ2	–	18 to 14		
	B1, B2	–	18 to 14		
	⊕	14	18 to 14		
BA0006	R/L1, S/L2, T/L3	12	14 to 10	M4	1.2 to 1.5 (10.6 to 13.3)
	U/T1, V/T2, W/T3	14	14 to 10		
	ϕ, ϕ1, ϕ2	–	14 to 10		
	B1, B2	–	14 to 10		
	⊕	10	14 to 10		
BA0010	R/L1, S/L2, T/L3	10	14 to 10	M4	1.2 to 1.5 (10.6 to 13.3)
	U/T1, V/T2, W/T3	14	14 to 10		
	ϕ, ϕ1, ϕ2	–	14 to 10		
	B1, B2	–	14 to 10		
	⊕	10	14 to 10		

### ■ Three-Phase 200 V Class

**Table 3.3 Wire Gauge and Torque Specifications**

Drive Model	Terminal	Recomm. Gauge AWG, kcmil	Wire Range AWG, kcmil	Screw Size	Tightening Torque N·m (lb.in.)
2A0001 2A0002 2A0004 2A0006	R/L1, S/L2, T/L3	14	18 to 14	M3.5	0.8 to 1.0 (7.1 to 8.9)
	U/T1, V/T2, W/T3	14	18 to 14		
	ϕ, ϕ1, ϕ2	–	18 to 14		
	B1, B2	–	18 to 14		
	⊕	14	18 to 14		

## 3.6 Main Circuit Wiring

Drive Model	Terminal	Recomm. Gauge AWG, kcmil	Wire Range AWG, kcmil	Screw Size	Tightening Torque N•m (lb.in.)
2A0010	R/L1, S/L2, T/L3	14	14 to 10	M4	1.2 to 1.5 (10.6 to 13.3)
	U/T1, V/T2, W/T3	14	14 to 10		
	ϕ, ϕ1, ϕ2	–	14 to 10		
	B1, B2	–	14 to 10		
	⊕	10	14 to 10		
2A0012	R/L1, S/L2, T/L3	12	14 to 10	M4	1.2 to 1.5 (10.6 to 13.3)
	U/T1, V/T2, W/T3	14	14 to 10		
	ϕ, ϕ1, ϕ2	–	14 to 10		
	B1, B2	–	14 to 10		
	⊕	10	14 to 10		
2A0020	R/L1, S/L2, T/L3	10	14 to 10	M4	1.2 to 1.5 (10.6 to 13.3)
	U/T1, V/T2, W/T3	10	14 to 10		
	ϕ, ϕ1, ϕ2	–	14 to 10		
	B1, B2	–	14 to 10		
	⊕	10	14 to 10		

## ■ Three-Phase 400 V Class

Table 3.4 Wire Gauge and Torque Specifications

Drive Model	Terminal	Recomm. Gauge AWG, kcmil	Wire Range AWG, kcmil	Screw Size	Tightening Torque N•m (lb.in.)
4A0001 4A0002 4A0004	R/L1, S/L2, T/L3	14	14 to 10	M4	1.2 to 1.5 (10.6 to 13.3)
	U/T1, V/T2, W/T3	14	14 to 10		
	ϕ, ϕ1, ϕ2	–	14 to 10		
	B1, B2	–	14 to 10		
	⊕	14	14 to 10		
4A0005 4A0007 4A0009	R/L1, S/L2, T/L3	14	14 to 10	M4	1.2 to 1.5 (10.6 to 13.3)
	U/T1, V/T2, W/T3	14	14 to 10		
	ϕ, ϕ1, ϕ2	–	14 to 10		
	B1, B2	–	14 to 10		
	⊕	10	14 to 10		



Drive Model	Terminal	Recomm. Gauge AWG, kcmil	Wire Range AWG, kcmil	Screw Size	Tightening Torque N·m (lb.in.)
4A0011	R/L1, S/L2, T/L3	12	14 to 10	M4	1.2 to 1.5 (10.6 to 13.3)
	U/T1, V/T2, W/T3	14	14 to 10		
	⊖, ⊕1, ⊕2	–	14 to 10		
	B1, B2	–	14 to 10		
	⊕	10	14 to 10		

### ◆ Main Circuit Terminal Power Supply and Motor Wiring

This section outlines the various steps, precautions, and checkpoints for wiring the main circuit terminals and motor terminals.

**NOTICE:** When connecting the motor to the drive output terminals U/T1, V/T2, and W/T3, the phase order for the drive and motor should match. Failure to comply with proper wiring practices may cause the motor to run in reverse if the phase order is backward.

**NOTICE:** Route motor leads U/T1, V/T2, and W/T3 separate from all other leads to reduce possible interference related issues. Failure to comply may result in abnormal operation of drive and nearby equipment.

**NOTICE:** Do not connect phase-advancing capacitors or LC/RC noise filters to the output circuits. Improper application of noise filters could result in damage to the drive.

**NOTICE:** Do not connect the AC power line to the output motor terminals of the drive. Failure to comply could result in death or serious injury by fire as a result of drive damage from line voltage application to output terminals.

### ■ Cable Length Between Drive and Motor

When the cable length between the drive and the motor is too long (especially at low frequency output), note that the cable voltage drop may cause reduced motor torque. Drive output current will increase as the leakage current from the cable increases. An increase in leakage current may trigger an overcurrent situation and weaken the accuracy of the current detection.

Adjust the drive carrier frequency according to the following table. If the motor wiring distance exceeds 100 m because of the system configuration, reduce the ground currents.

Refer to [Table 3.5](#) to set the carrier frequency to an appropriate level.

**Table 3.5 Cable Length Between Drive and Motor**

Cable Length	50 m or less	100 m or less	Greater than 100 m
Carrier Frequency	15 kHz or less	5 kHz or less	2 kHz or less

**Note:** When setting carrier frequency, calculate the cable length as the total distance of wiring to all connected motors when running multiple motors from a single drive.

### ■ Ground Wiring

Follow the precautions to wire the ground for one drive or a series of drives.

## 3.6 Main Circuit Wiring

---

**WARNING!** *Electrical Shock Hazard. Always use a ground wire that complies with technical standards on electrical equipment and minimize the length of the ground wire. Improper equipment grounding may cause dangerous electrical potentials on equipment chassis, which could result in death or serious injury.*

**WARNING!** *Electrical Shock Hazard. Be sure to ground the drive ground terminal. (200 V Class: Ground to 100  $\Omega$  or less, 400 V Class: Ground to 10  $\Omega$  or less). Improper equipment grounding could result in death or serious injury by contacting ungrounded electrical equipment.*

**NOTICE:** *Do not share the ground wire with other devices such as welding machines or large-current electrical equipment. Improper equipment grounding could result in drive or equipment malfunction due to electrical interference.*

**NOTICE:** *When using more than one drive, ground multiple drives according to instructions. Improper equipment grounding could result in abnormal operation of drive or equipment.*

Refer to [Figure 3.9](#) when using multiple drives. Do not loop the ground wire.

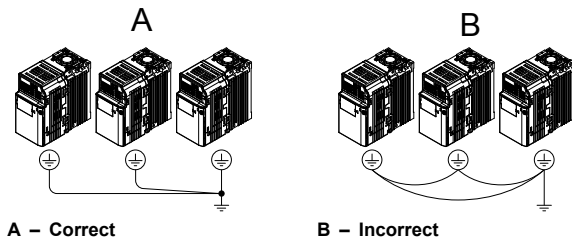
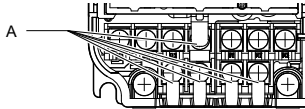


Figure 3.9 Multiple Drive Wiring

### ■ Wiring the Main Circuit Terminal

**WARNING!** *Electrical Shock Hazard. Shut off the power supply to the drive before wiring the main circuit terminals. Failure to comply may result in death or serious injury.*

**Note:** A cover placed over the DC Bus and braking circuit terminals prior to shipment helps prevent miswiring. Cut away covers as needed for terminals with a needle-nose pliers.



**A – Protective Cover to Prevent Miswiring**

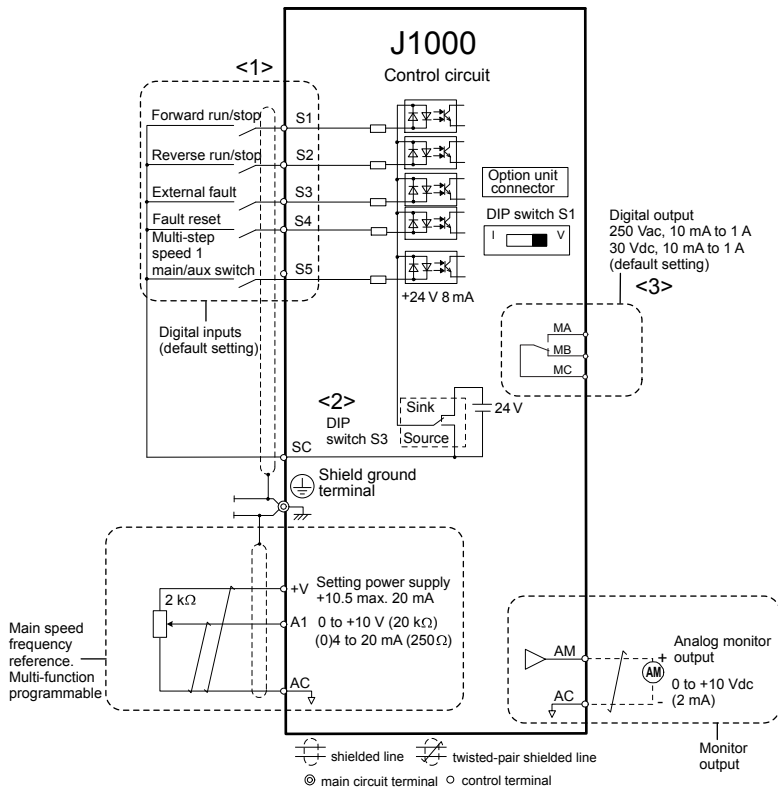
### Main Circuit Connection Diagram

Refer to section [3.3 Main Circuit Connection Diagram](#) on page [42](#) for drive main power circuit connections.

**WARNING!** *Fire Hazard. The braking resistor connection terminals are B1 and B2. Do not connect braking resistors to any other terminals. Improper wiring connections could cause the braking resistor to overheat and cause death or serious injury by fire. Failure to comply may result in damage to the braking circuit or drive.*

## 3.7 Control Circuit Wiring

**NOTICE:** Do not solder the ends of wire connections to the drive. Soldered wire connections can loosen over time. Improper wiring practices could result in drive malfunction due to loose terminal connections.



**Figure 3.10 Control Circuit Connection Diagram**

<1> Connected using sequence input signal (S1 to S5) from NPN transistor; Default: sink mode (0 V com)

<2> Use only the +24 V internal power supply in sinking mode; the source mode requires an external power supply. [Refer to I/O Connections on page 59.](#)

<3> Minimum load: 5 Vdc, 10 mA (reference value).

### ◆ Control Circuit Terminal Block Functions

Drive parameters determine which functions apply to the multi-function digital inputs (S1 to S5), multi-function digital outputs (MA, MB, MC), and multi-function analog output (AM). The default is called out next to each terminal in [Figure 3.10](#).

**WARNING!** *Sudden Movement Hazard. Always check the operation and wiring of control circuits after being wired. Operating a drive with untested control circuits could result in death or serious injury.*

**WARNING!** *Confirm the drive I/O signals and external sequence before starting test run. Failure to comply may result in death or serious injury.*

### ■ Input Terminals

**Table 3.6 Control Circuit Input Terminals**

Type	No.	Terminal Name (Function)	Function (Signal Level) Default Setting
Multi-Function Digital Inputs	S1	Multi-function input 1 (Closed: Forward run, Open: Stop)	24 Vdc, 8 mA <b>Note:</b> Drive preset to sinking mode. When using source mode, set DIP switch S3 to allow for a 24 Vdc ( $\pm 10\%$ ) external power supply. <a href="#">Refer to Sinking/Sourcing Mode Switch on page 59</a> .
	S2	Multi-function input 2 (Closed: Reverse run, Open: Stop)	
	S3	Multi-function input 3 (External fault (N.O.))	
	S4	Multi-function input 4 (Fault reset)	
	S5	Multi-function input 5 (Multi-step speed reference 1)	
	SC	Multi-function input common (Control common)	Sequence common
Main Frequency Reference Input	A1	Frequency reference	Input voltage or input current (Selected by DIP switch S1 and H3-01) 0 to +10 Vdc (20 k $\Omega$ ), Resolution: 1/1000 4 to 20 mA (250 $\Omega$ ) or 0 to 20 mA (250 $\Omega$ ), Resolution: 1/500
	+V	Analog input power supply	+10.5 Vdc (max allowable current 20 mA)
	AC	Frequency reference common	0 Vdc

## 3.7 Control Circuit Wiring

### Output Terminals

Table 3.7 Control Circuit Output Terminals

Type	No.	Terminal Name (Function)	Function (Signal Level) Default Setting
Multi-Function Digital Output	MA	N.O. output (fault)	Digital output 30 Vdc, 10 mA to 1 A; 250 Vac, 10 mA to 1 A Minimum load: 5 Vdc, 10 mA (reference value)
	MB	N.C. output (fault)	
	MC	Digital output common	
Monitor Output	AM	Analog monitor output	0 to 10 Vdc (2 mA or less) Resolution: 1/256
	AC	Monitor common	0 V

### Terminal Configuration

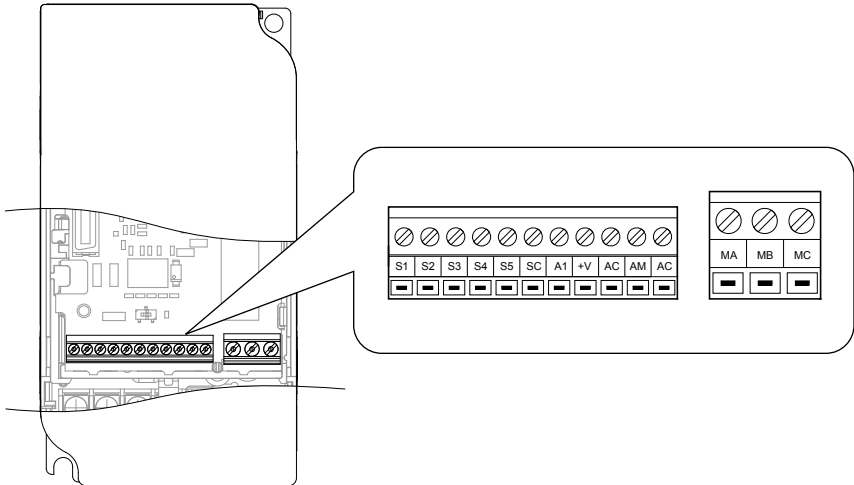


Figure 3.11 Control Circuit Terminal

### ■ Wire Size and Torque Specifications

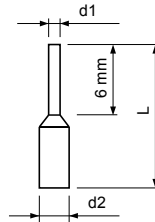
Select appropriate wire type and size from [Table 3.8](#). For simpler and more reliable wiring, crimp ferrules to the wire ends. Refer to [Table 3.9](#) for ferrule terminal types and sizes.

**Table 3.8 Wire Size and Torque Specifications (Same for All Models)**

Terminal	Screw Size	Tightening Torque N·m	Tightening Torque (in-lbs)	Bare Wire Terminal		Ferrule-Type Terminal		
				Applic. wire size mm <sup>2</sup> (AWG)	Recomm. mm <sup>2</sup> (AWG)	Applic. wire size mm <sup>2</sup> (AWG)	Recomm. mm <sup>2</sup> (AWG)	Wire Type
MA, MB, MC	M3	0.5 to 0.6	4.4 to 5.3	Stranded: 0.25 to 1.5 (24 to 16) Single: 0.25 to 1.5 (24 to 16)	0.75 (18)	0.25 to 1.0 (24 to 17)	0.5 (20)	Shielded line, etc.
S1-S5, SC, +V, A1, AC, AM	M2	0.22 to 0.25	1.9 to 2.2	Stranded: 0.25 to 1.0 (24 to 18) Single: 0.25 to 1.5 (24 to 16)	0.75 (18)	0.25 to 0.5 (24 to 20)	0.5 (20)	

### ■ Ferrule-Type Wire Terminations

Crimp a ferrule to signal wiring to improve wiring simplicity and reliability. Use CRIMPFOX 6, a crimping tool manufactured by PHOENIX CONTACT.



**Figure 3.12 Ferrule Dimensions**

## 3.7 Control Circuit Wiring

Table 3.9 Ferrule Terminal Types and Sizes

Size mm <sup>2</sup> (AWG)	Type	L (mm)	d1 (mm)	d2 (mm)	Manufacturer
0.25 (24)	AI 0.25-6YE	10.5	0.8	2.0	PHOENIX CONTACT
0.34 (22)	AI 0.34-6TQ	10.5	0.8	2.0	
0.5 (20)	AI 0.5-6WH	12	1.1	2.5	
0.75 (18)	AI 0.75-6GY	12	1.3	2.8	
1.0	AI 1-6RD	12	1.5	3.0	

### ◆ Wiring Procedure

This section describes the proper procedures and preparations for wiring the control terminals.

**WARNING!** *Electrical Shock Hazard. Do not remove covers or touch the circuit boards while the power is on. Failure to comply could result in death or serious injury.*

**NOTICE:** *Separate control circuit wiring from main circuit wiring (terminals R/L1, S/L2, T/L3, B1, B2, U/T1, V/T2, W/T3, -, +1, +2) and other high-power lines. Improper wiring practices could result in drive malfunction due to electrical interference.*

**NOTICE:** *Separate wiring for digital output terminals MA, MB and MC from wiring to other control circuit lines. Improper wiring practices could result in drive or equipment malfunction or nuisance trips.*

**NOTICE:** *Use a class 2 power supply (UL standard) when connecting to the control terminals. Improper application of peripheral devices could result in drive performance degradation due to improper power supply.*

**NOTICE:** *Insulate shields with tape or shrink tubing to prevent contact with other signal lines and equipment. Improper wiring practices could result in drive or equipment malfunction due to short circuit.*

**NOTICE:** *Connect the shield of shielded cable to the appropriate ground terminal. Improper equipment grounding could result in drive or equipment malfunction or nuisance trips.*

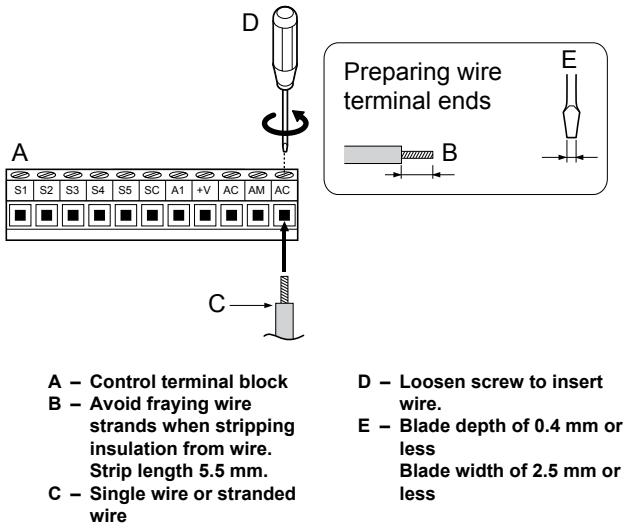
Wire the control terminals using [Figure 3.13](#) as a guide. Prepare the ends of the control circuit wiring as shown in [Figure 3.14](#). [Refer to Wire Size and Torque Specifications on page 55.](#)

**NOTICE:** *Do not tighten screws beyond the specified tightening torque. Failure to comply may damage the terminal.*

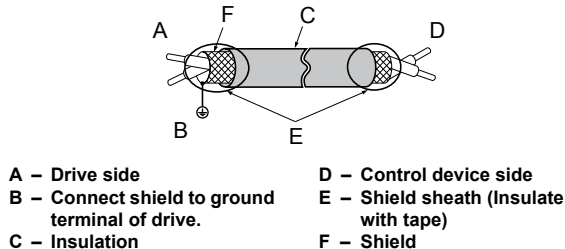
**NOTICE:** *Use shielded twisted-pair cables as indicated to prevent operating faults. Improper wiring practices could result in drive or equipment malfunction due to electrical interference.*

Connect control wires as shown in the following figure:





**Figure 3.13 Terminal Board Wiring Guide**



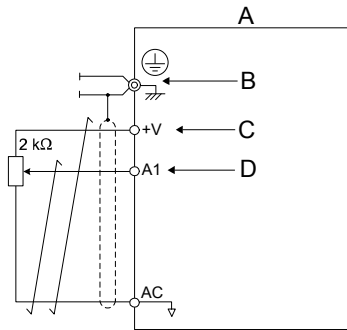
**Figure 3.14 Preparing the Ends of Shielded Cables**

When setting the frequency by analog reference from an external potentiometer, use shielded twisted-pair wires and ground the shield of twisted-pair wires to the ground terminal of the drive.

**NOTICE:** *The analog signal lines between the drive and the operator station or peripheral equipment should not exceed 50 meters when using an analog signal from a remote source to supply the frequency reference. Failure to comply could result in poor system performance.*

### 3.7 Control Circuit Wiring

---



- A** – Drive
- B** – Ground terminal (shield connection)
- C** – (+V) Frequency setting power source +10.5 Vdc maximum 20 mA
- D** – (A1) Main speed frequency reference 0 to +10 Vdc (20 kΩ)  
or  
4 to 20 mA (250 Ω)/  
0 to 20 mA (250 Ω)

**Figure 3.15** Wiring the Frequency Reference to the Control Circuit Terminals (External Reference)

## 3.8 I/O Connections

### ◆ Sinking/Sourcing Mode Switch

Set the DIP switch S3 on the front of the drive to switch the digital input terminal logic between sinking mode and sourcing mode; the drive is preset to sinking mode.

Table 3.10 Sinking/Sourcing Mode Setting

Set Value	Details
SINK	Sinking Mode (0 V common): default setting
SOURCE	Sourcing Mode (+24 V common)

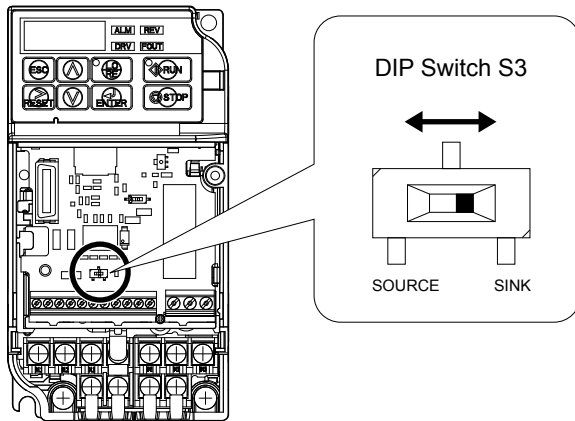


Figure 3.16 DIP Switch S3

## 3.8 I/O Connections

### ■ Transistor Input Signal Using 0 V Common/Sink Mode

When controlling the digital inputs by NPN transistors (0 V common/sinking mode), set the DIP switch S3 to SINK and use the internal 24 V power supply.

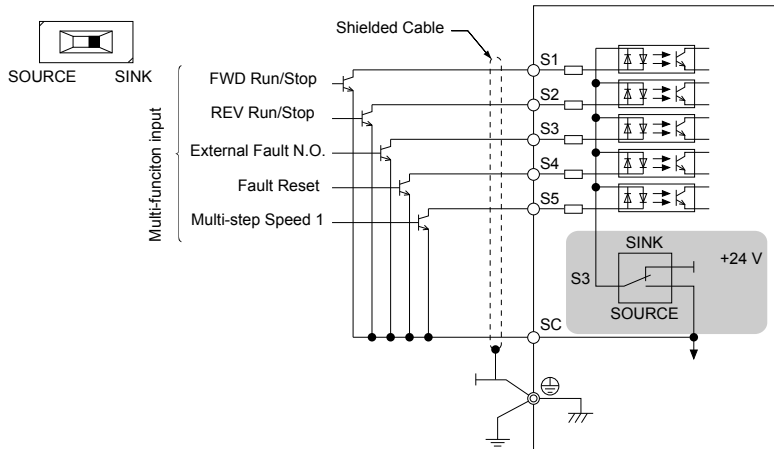


Figure 3.17 Sinking Mode: Sequence from NPN Transistor (0 V Common)

### ■ Transistor Input Signal Using +24 V Common/Source Mode

When controlling digital inputs by PNP transistors (+24 V common/sourcing mode), set the DIP switch S3 to SOURCE and use an external 24 V power supply.

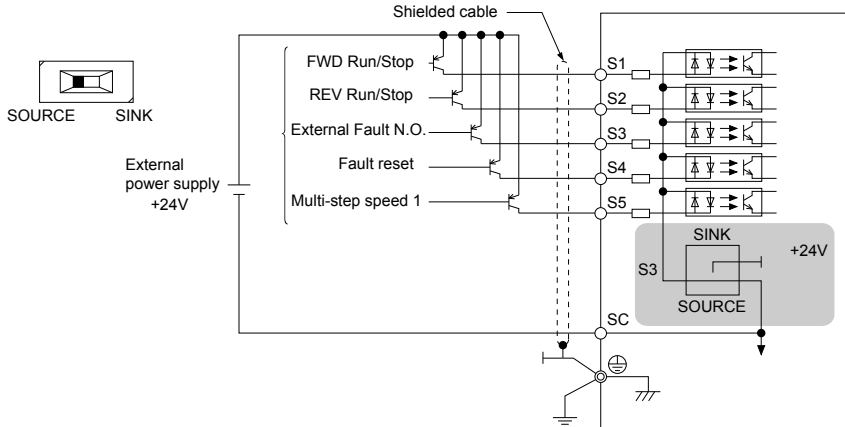


Figure 3.18 Source Mode: Sequence from PNP Transistor (+24 V Common)

## 3.9 Main Frequency Reference

### ◆ DIP Switch S1 Analog Input Signal Selection

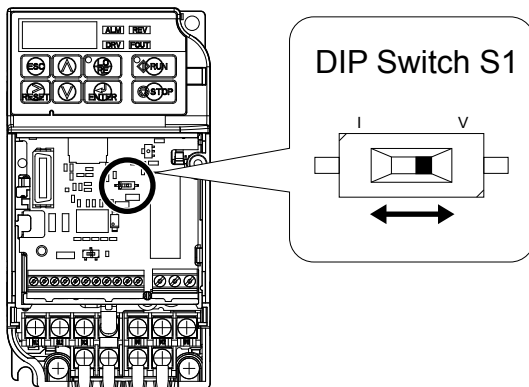
The main frequency reference can either be a voltage or current signal input at terminal A1.

When using input A1 as a voltage input, set DIP switch S1 to “V” (right position, default setting) and program parameter H3-01 to “0” (0 to +10 Vdc with lower limit) or “1” (0 to +10 Vdc without lower limit).

To use current input at terminal A1, set the DIP switch S1 to “I” and set parameter H3-01 = “2” or “3” (4-20 mA or 0-20 mA).

**Table 3.11 Frequency Reference Configurations**

Voltage Input	Current Input



**Figure 3.19 DIP Switch S1**

## 3.9 Main Frequency Reference

**Table 3.12 DIP Switch S1 Settings**

Setting Value	Description
V ( right position)	Voltage input (0 to 10 V): default setting
I ( left position)	Current input (4 to 20 mA or 0 to 20 mA)

**Table 3.13 Parameter H3-01 Details**

No.	Parameter Name	Description	Setting Range	Default Setting	MEMOBUS Register
H3-01	Frequency ref. (voltage/current) terminal A1 signal level selection	Selects the signal level for terminal A1. 0: 0 to +10 V, unipolar input (negative frequency reference values are zeroed) 1: 0 to +10 V, bipolar input (negative frequency reference changes the direction) 2: 4 to 20 mA 3: 0 to 20 mA	0 to 3	0	410

### 3.10 Braking Resistor

Dynamic braking (DB) helps bring the motor to a smooth and rapid stop when working with high inertia loads. Regeneration occurs as the drive lowers the motor frequency with high inertia. When the regeneration flows back into the DC bus capacitors, an overvoltage situation occurs. A braking resistor prevents these overvoltage faults.

**NOTICE:** *Do not allow unqualified personnel to use the product. Failure to comply could result in damage to the drive or braking circuit. Carefully review the braking resistor instruction manual when connecting a braking option to the drive.*

**Note:** The braking circuit must be sized properly in order to dissipate the power required to decelerate the load in the desired time. Ensure that the braking circuit can dissipate the energy for the set deceleration time prior to running the drive.

**NOTICE:** *Use a thermal overload relay or over-temperature contact to interrupt input power to the drive if the braking resistor overheats. In the event of a possible thermal overload, the relay triggers the input contactor and prevents the braking resistor from burning up.*

---

### ◆ Installation

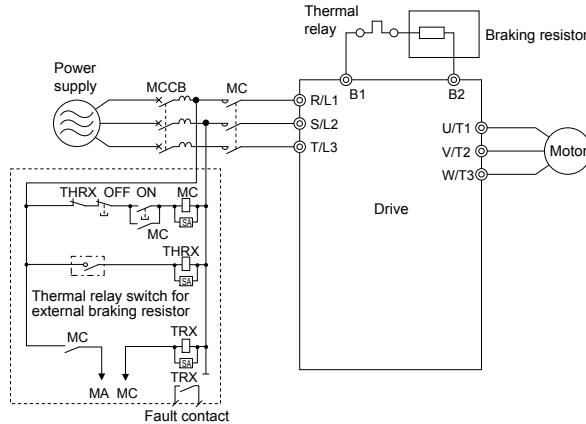
**WARNING! Fire Hazard.** *The braking resistor connection terminals are B1 and B2. Do not connect a braking resistor directly to any other terminals. Improper wiring connections could result in death or serious injury by fire. Failure to comply may result in damage to the braking circuit or drive.*

**NOTICE:** *Connect braking resistors to the drive as shown in the I/O wiring examples. Improperly wiring braking circuits could result in damage to the drive or equipment.*

### ■ Installation Procedure

1. Disconnect all electrical power to the drive and wait at least one minute before servicing the drive and any connected components.
2. Remove drive front cover.
3. Use a voltmeter to verify that voltage is disconnected from incoming power terminals and that the DC bus no longer holds a charge.





**Figure 3.20 Connecting a Braking Resistor**

- Follow manufacturer instructions to connect the resistor unit to the drive using proper wire gauge according to local electrical codes.

Power leads for the remote mount resistors generate high levels of electrical noise; group these signal leads separately.

- Mount the resistor unit on a noncombustible surface. Maintain minimum side and top clearances according to resistor manufacturer instructions.

**WARNING! Fire Hazard.** Do not use improper combustible materials. Failure to comply could result in death or serious injury by fire. Attach the drive or braking resistors to metal or other noncombustible material.

- Reinstall drive covers and resistor covers, if provided.
- Set parameter L3-04 = "0" to disable stall prevention during deceleration.  
Set parameter L8-01 to "1" to enable overheat protection when using a heatsink-mounted braking resistor option.  
Set L8-01 = "0" for other braking resistor types.

**Table 3.14 Braking Resistor Settings**

Parameter	Settings
L8-01: Internal Dynamic Braking Resistor Protection Selection	0: Disabled. The drive will not provide overheat protection. Supply separate means of overheat protection. 1: Enabled. Braking Resistor is protected from overheat.
L3-04: Stall Prevention During Decel	0: Stall prevention disabled.

- Operate the system and verify the required deceleration rate is obtained during dynamic braking or stopping.

### 3.11 Interlocking with Connected Machinery

For safety reasons, applications that may be affected by the operation status of the drive should be set up so that operation can only occur when the drive is ready to operate. A "Drive ready" and "Fault" signal should be assigned to the multi-function outputs to guarantee interlock with application.

---

#### ◆ Drive Ready Signal

When the "Drive ready" signal has been set to one of the multi-function contact outputs, that output will close whenever the drive is ready to accept a Run command or is already running. Under the following conditions the Drive ready signal will switch off and remain off, even if a Run command is entered:

- when the power supply is shut off
- during a fault
- when there is problem with the control power supply
- when a parameter setting error makes the drive unable to run even if a Run command has been entered
- when a fault such as overvoltage or undervoltage is triggered as soon as the Run command is entered
- when the drive is in the Programming mode and will not accept a Run command even when entered.

## 3.12 Wiring Checklist

<input checked="" type="checkbox"/>	No.	Item	Page	
<b>Drive, peripherals, option cards</b>				
<input type="checkbox"/>	1	Check drive model number to ensure receipt of correct model.	19	
<input type="checkbox"/>	2	Check for correct braking resistors, DC link chokes, noise filters, and other peripheral devices.	64	
<b>Installation area and physical setup</b>				
<input type="checkbox"/>	3	Ensure area surrounding the drive complies with specifications.	29	
<b>Power supply voltage, output voltage</b>				
<input type="checkbox"/>	4	The voltage from the power supply should fall within the input voltage specification range of the drive.		
<input type="checkbox"/>	5	The voltage rating for the motor should match the drive output specifications.	19	
<b>Main circuit wiring</b>				
<input type="checkbox"/>	6	Confirm proper branch circuit protection exists per National and Local codes.	39	
<input type="checkbox"/>	7	Properly wire the power supply to drive terminals R/L1, S/L2 and T/L3.	42	
<input type="checkbox"/>	8	Properly wire the drive and motor together. The motor lines and drive output terminals R/T1, V/T2 and W/T3 should match in order to produce the desired phase order. If the phase order is incorrect, the drive will rotate in the opposite direction.	49	
<input type="checkbox"/>	9	Use 600 Vac vinyl-sheathed wire for the power supply and motor lines.	46	
<input type="checkbox"/>	10	Use the correct wire gauges for the main circuit. Refer to <a href="#">Table 3.2</a> through <a href="#">Table 3.4</a> .	46	
		<ul style="list-style-type: none"> <li>When using comparatively long motor cable, calculate the amount of voltage drop. <table border="1" style="margin-left: 20px;"> <tr> <td> <math display="block">\text{Motor rated voltage (V)} \times 0.02 \geq</math> <math display="block">3 \times \text{voltage resistance } (\Omega/\text{km}) \times \text{cable length (m)} \times \text{motor rated current (A)} \times 10^{-3}</math> </td> </tr> </table> </li> </ul>	$\text{Motor rated voltage (V)} \times 0.02 \geq$ $3 \times \text{voltage resistance } (\Omega/\text{km}) \times \text{cable length (m)} \times \text{motor rated current (A)} \times 10^{-3}$	46
$\text{Motor rated voltage (V)} \times 0.02 \geq$ $3 \times \text{voltage resistance } (\Omega/\text{km}) \times \text{cable length (m)} \times \text{motor rated current (A)} \times 10^{-3}$				
		<ul style="list-style-type: none"> <li>If the cable between the drive and motor exceeds 50 m, adjust the carrier frequency (C6-02) accordingly.</li> </ul>	49	
<input type="checkbox"/>	11	Properly ground the drive. Review page <a href="#">49</a> .	49	
<input type="checkbox"/>	12	Tightly fasten all terminal screws (control circuit terminals, grounding terminals). Refer to <a href="#">Table 3.2</a> through <a href="#">Table 3.4</a> .	46	

### 3.12 Wiring Checklist

☑	No.	Item	Page
☐	13	<p>Set up overload protection circuits when running multiple motors from a single drive.</p> <p>MC1 - MCn ... magnetic contactor OL 1 - OL n ... thermal relay</p> <p><b>Note:</b> Close MC1 through MCn before operating the drive.</p>	-
☐	14	If using a braking resistor or dynamic braking resistor unit, install a magnetic contactor. Properly install the resistor, and ensure that overload protection shuts off the power supply.	64
☐	15	Verify phase advancing capacitors are NOT installed on the output side of the drive.	-
<b>Control circuit wiring</b>			
☐	16	Use twisted-pair cables for all drive control circuit wiring.	52
☐	17	Ground the shields of shielded wiring to the GND ⊕ terminal.	56
☐	18	If using a 3-Wire sequence, properly set parameters for multi-function contact input terminals S1 through S5, and properly wire control circuits.	41
☐	19	Check for any other wiring mistakes. Only use a multimeter to check wiring.	-
☐	20	Properly fasten the control circuit terminal screws in the drive. Refer to <a href="#">Table 3.2</a> through <a href="#">Table 3.4</a> .	46
☐	21	Pick up all wire clippings.	-
☐	22	Ensure that no frayed wires on the terminal block are touching other terminals or connections.	-
☐	23	Properly separate control circuit wiring and main circuit wiring.	-
☐	24	Analog signal line wiring should not exceed 50 m.	-

# 4

## Start-Up Programming & Operation

---

This chapter explains the functions of the LED operator and how to program the drive for initial operation.

<b>4.1</b>	<b>SECTION SAFETY.....</b>	<b>70</b>
<b>4.2</b>	<b>USING THE DIGITAL LED OPERATOR.....</b>	<b>73</b>
<b>4.3</b>	<b>THE DRIVE AND PROGRAMMING MODES.....</b>	<b>79</b>
<b>4.4</b>	<b>START-UP FLOWCHART.....</b>	<b>87</b>
<b>4.5</b>	<b>BASIC OPERATION.....</b>	<b>88</b>
<b>4.6</b>	<b>POWERING UP THE DRIVE.....</b>	<b>112</b>
<b>4.7</b>	<b>NO-LOAD OPERATION TEST RUN.....</b>	<b>114</b>
<b>4.8</b>	<b>TEST RUN WITH LOAD CONNECTED.....</b>	<b>116</b>
<b>4.9</b>	<b>VERIFYING AND BACKING UP PARAMETER SETTINGS.....</b>	<b>117</b>
<b>4.10</b>	<b>TEST RUN CHECKLIST.....</b>	<b>119</b>

# 4.1 Section Safety

### DANGER

#### Electrical Shock Hazard

**Do not connect or disconnect wiring while the power is on.**

Failure to comply will result in death or serious injury.

### WARNING

#### Electrical Shock Hazard

**Do not operate equipment with covers removed.**

Failure to comply could result in death or serious injury.

The diagrams in this section may include drives without covers or safety shields to illustrate details. Be sure to reinstall covers or shields before operating the drives and run the drives according to the instructions described in this manual.

**Always ground the motor-side grounding terminal.**

Improper equipment grounding could result in death or serious injury by contacting the motor case.

**Do not touch any terminals before the capacitors have fully discharged.**

Failure to comply could result in death or serious injury.

Before wiring terminals, disconnect all power to the equipment. The internal capacitor remains charged even after the power supply is turned off. The charge indicator LED will extinguish when the DC bus voltage is below 50 Vdc. To prevent electric shock, wait at least one minute after all indicators are off and measure the DC bus voltage level to confirm safe level.

**Do not allow unqualified personnel to perform work on the drive.**

Failure to comply could result in death or serious injury.

Installation, maintenance, inspection, and servicing must be performed only by authorized personnel familiar with installation, adjustment and maintenance of AC drives.

 **WARNING**

**Do not perform work on the drive while wearing loose clothing, jewelry or without eye protection.**

Failure to comply could result in death or serious injury.

Remove all metal objects such as watches and rings, secure loose clothing, and wear eye protection before beginning work on the drive.

**Do not remove covers or touch circuit boards while the power is on.**

Failure to comply could result in death or serious injury.

### **Fire Hazard**

**Tighten all terminal screws to the specified tightening torque.**

Loose electrical connections could result in death or serious injury by fire due to overheating of electrical connections.

**Do not use an improper voltage source.**

Failure to comply could result in death or serious injury by fire.

Verify that the rated voltage of the drive matches the voltage of the incoming power supply before applying power.

**Do not use improper combustible materials.**

Failure to comply could result in death or serious injury by fire.

Attach the drive to metal or other noncombustible material.

### NOTICE

**Observe proper electrostatic discharge procedures (ESD) when handling the drive and circuit boards.**

Failure to comply may result in ESD damage to the drive circuitry.

**Never connect or disconnect the motor from the drive while the drive is outputting voltage.**

Improper equipment sequencing could result in damage to the drive.

**Do not use unshielded cable for control wiring.**

Failure to comply may cause electrical interference resulting in poor system performance. Use shielded twisted-pair wires and ground the shield to the ground terminal of the drive.

**Do not allow unqualified personnel to use the product.**

Failure to comply could result in damage to the drive or braking circuit.

Carefully review instruction manual TOBPC72060000 when connecting a braking option to the drive.

**Do not modify the drive circuitry.**

Failure to comply could result in damage to the drive and will void warranty.

Yaskawa is not responsible for any modification of the product made by the user. This product must not be modified.

**Check all the wiring to ensure that all connections are correct after installing the drive and connecting any other devices.**

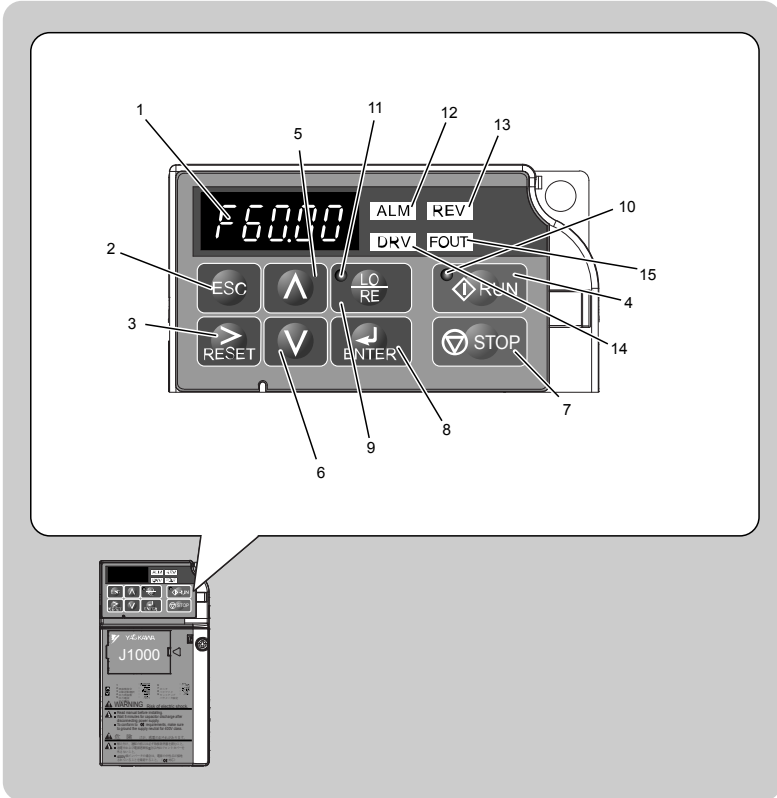
Failure to comply could result in damage to the drive.



## 4.2 Using the Digital LED Operator

Use the LED operator to enter run and stop commands, display data, edit parameters, as well as display fault and alarm information.

### ◆ Keys, Displays, and LEDs



## 4.2 Using the Digital LED Operator

**Table 4.1 Keys and Displays on the LED Operator**

No.	Display	Name	Function
1		Data Display Area	Displays the frequency reference, parameter number, etc.
2		ESC Key	Returns to the previous menu.
3		RESET Key	Moves the cursor to the right. Resets the drive to clear a fault situation.
4		RUN Key	Starts the drive.
5		Up Arrow Key	Scrolls up to select parameter numbers, setting values, etc.
6		Down Arrow Key	Scrolls down to select parameter numbers, setting values, etc.
7		STOP Key	Stops the drive. <b>Note:</b> Stop priority circuit. Pressing the STOP key will always cause the drive to stop the motor, even if a Run command is active at any external Run command source. Set parameter o2-06 to 0 to disable the STOP key priority.
8		ENTER Key	Selects all modes, parameters, settings, etc. Selects a menu item to move from one display screen to the next.
9		LO/RE Selection Key	Switches drive control between the operator (LOCAL) and the control circuit terminals (REMOTE). <b>Note:</b> LOCAL/REMOTE key effective during stop in drive mode.
10		RUN Light	Lit while the drive is operating the motor.
11		LO/RE Light	Lit while the operator (LOCAL) is selected to run the drive.
12		ALM LED Light	<i>Refer to LED Screen Displays on page 76.</i>
13		REV LED Light	
14		DRV LED Light	
15		FOUT LED Light	

### ◆ Digital Text Display

Text appears on the LED Operator as shown below. This section explains the meaning of text as it appears on the display screen.

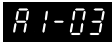



Lit	Flashing
	




Table 4.2 Digital Text Display

Text	LED	Text	LED	Text	LED	Text	LED
0	0	9	9	I	i	R	r
1	1	A	A	J	j	S	S
2	2	B	b	K	k	T	T
3	3	C	C	L	L	U	U
4	4	D	d	M		V	v
5	5	E	E	N	n	W	
6	6	F	F	O	o	X	None
7	7	G	G	P	p	Y	y
8	8	H	H	Q	q	Z	None







<1> Displayed in two digits.

## 4.2 Using the Digital LED Operator

### ◆ LED Screen Displays

Display	Lit	Flashing	Off
<b>ALM</b>	When the drive detects an alarm or error	<ul style="list-style-type: none"> <li>When an alarm occurs</li> <li>oPE detected</li> </ul>	Normal state (no fault or alarm)
<b>REV</b>	Motor is rotating in reverse	—	Motor is rotating forward
<b>DRV</b>	Drive Mode	—	Programming Mode
<b>FOUT</b>	Displays output frequency (Hz)	—	—
As illustrated in this manual			

### ◆ LO/RE LED and RUN LED Indications

LED	Lit	Flashing	Flashing Quickly <1>	Off
	When a Run command is selected from the LED operator (LOCAL)	—	—	Run command is selected from device other than LED operator (REMOTE)
	During Run	<ul style="list-style-type: none"> <li>During deceleration to stop</li> <li>When a Run command is input and frequency reference is 0</li> </ul>	<ul style="list-style-type: none"> <li>During deceleration at a fast-stop.</li> <li>During stop by interlock operation.</li> </ul>	During stop
As shown				

<1> Refer to [Figure 4.1](#) for the difference between “flashing” and “flashing quickly”.

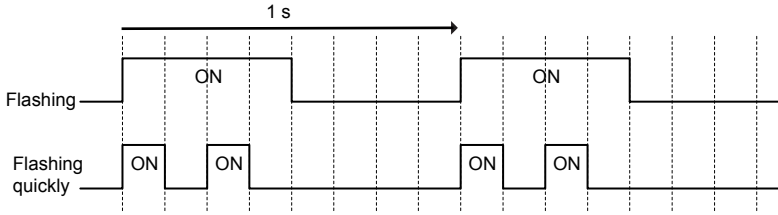


Figure 4.1 RUN LED Status and Meaning

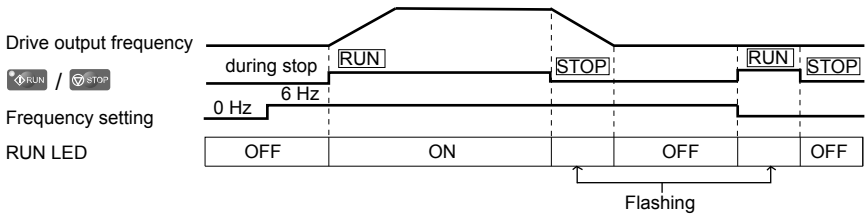


Figure 4.2 RUN LED and Drive Operation

### ◆ Menu Structure for Digital LED Operator

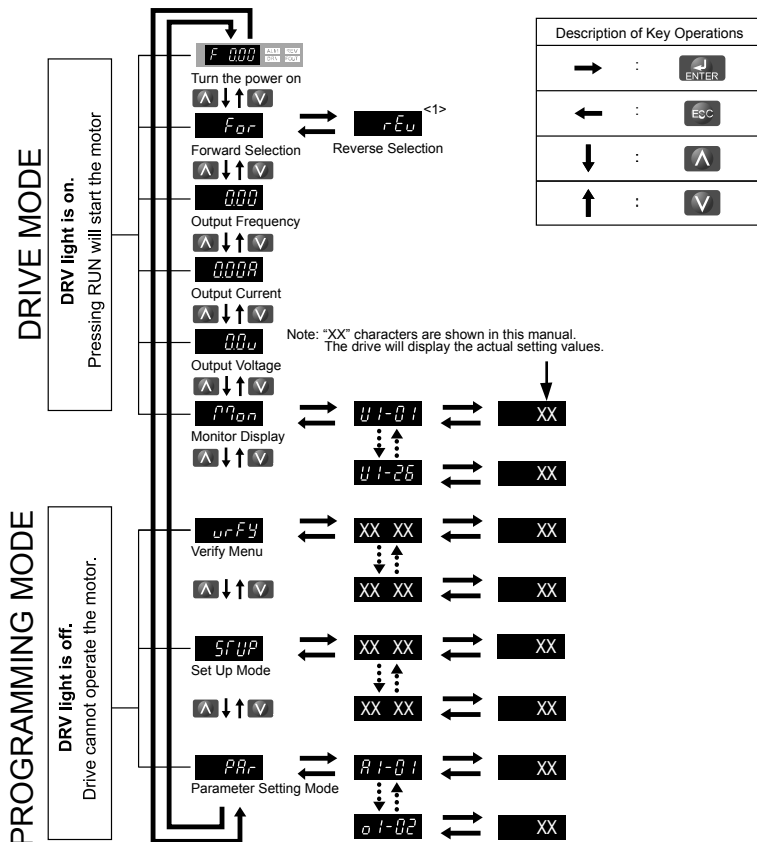


Figure 4.3 Digital LED Operator Screen Structure

<1> Reverse can only be selected when LOCAL is set.

## 4.3 The Drive and Programming Modes

The drive functions are divided into two main groups accessible via the Digital LED Operator:

**Drive Mode:** The Drive mode allows motor operation and parameter monitoring. Parameter settings cannot be changed when accessing functions in the Drive Mode ([Table 4.3](#)).

**Programming Mode:** The Programming Mode allows access to setup/adjust, verify parameters. The drive prohibits changes in motor operation such as start/stop when the Digital LED Operator is accessing a function in the Programming Mode.

[Table 4.3](#) illustrates the different functions visible as the “Up arrow” is scrolled immediately after powering up the drive.

**Note:** When b1-08 (Run Command Selection while in Programming Mode) is set to 1 (enabled), the drive can run even if the mode is switched to the programming mode. When setting b1-08 to 0 (disabled), the mode cannot be switched to the programming mode while the drive is running.



**Table 4.3 Summary of Modes**





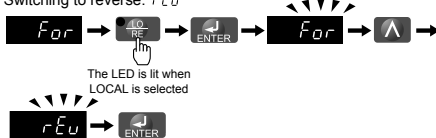








Mode Group	Description	Key Press	LED Digital Operator Display <1>
<b>Drive Mode Functions</b> (Motor operation and monitoring)	Frequency Reference Display (Initial power-up state)		
	Forward/Reverse		
	Output Frequency Display		
	Output Current Display		
	Output Voltage Reference		
	Monitor Display		
<b>Programming Mode Functions</b> (Changing parameters)	Verify Function		
	Setup Group Parameters		
	All Parameters		

<1> The enlarged illustration of the LED indicates that the LED is on.

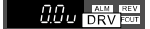
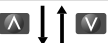

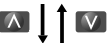
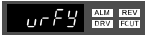






## 4.3 The Drive and Programming Modes

### ◆ Navigating the Drive and Programming Modes

The drive is set to operate in Drive Mode when it is first powered up. Switch between display screens using  and .

<p>Power Up</p>	<p>Frequency Reference</p>  <p>Default Setting</p>	<p>This display screen allows the user to monitor and set the frequency reference while the drive is running. <i>Refer to The Drive and Programming Modes on page 79.</i></p> <p><b>Note:</b> The user can select items to display when the drive is first powered up by setting parameter o1-02.</p>
<p>Drive Mode</p>	<p> </p> <p>Forward/Reverse</p> 	<p><i>For</i>: Motor rotates forward.</p> <p><i>rEv</i>: Motor rotates in reverse.</p> <p><b>Note:</b> For applications that should not run in reverse (fans, pumps, etc.), set parameter b1-04 = "1" to prohibit the motor from rotating in reverse. This sequence also puts the drive in LOCAL mode.</p> <p>Switching to reverse: <i>rEv</i></p>  <p>The LED is lit when LOCAL is selected</p>
<p>Drive Mode</p>	<p> </p> <p>Output Frequency Display</p>  <p> </p> <p>Output Current Display</p>  <p> </p>	<p>Monitors the frequency output by the drive.</p> <p>Monitors the output current of the drive.</p>



Drive Mode	Output Voltage Reference 	Monitors the output voltage of the drive.
		
	Monitor Display 	Monitor parameters (U parameters) are displayed.
Programming Mode		
	Verify Function 	Lists all parameters that have been edited or changed from default settings. → Refer to <a href="#">Verifying Parameter Changes: Verify Menu on page 84</a> .
		
	Setup 	A select list of parameters necessary to get the drive operational quickly. → Refer to <a href="#">The Setup Group within the Programming Mode on page 82</a> .
		
	Parameter Setting 	Allows the user to access and edit all parameter settings. → Refer to <a href="#">Parameter List on page 213</a> .
		
Drive Mode	Frequency Reference 	Returns to the frequency reference display screen.

#### ■ Drive Mode Details

The following actions are possible in the Drive Mode:

- Run and stop the drive.
- Monitor the operation status of the drive (frequency reference, output frequency, output current, output voltage, etc.).
- View information on an alarm.

**Note:** Select "Drive Mode" when running. The mode can be switched to any mode (program mode, etc.) other than drive mode while the drive is stopped. However, the drive cannot be operated in other modes. Return the mode to "Drive Mode" after completing periodic inspection.

**Figure 4.4** illustrates changing the default frequency reference of F 0.00 (0 Hz) to F 6.00 (6 Hz) while in Drive Mode. This example assumes the drive is set to LOCAL.

## 4.3 The Drive and Programming Modes

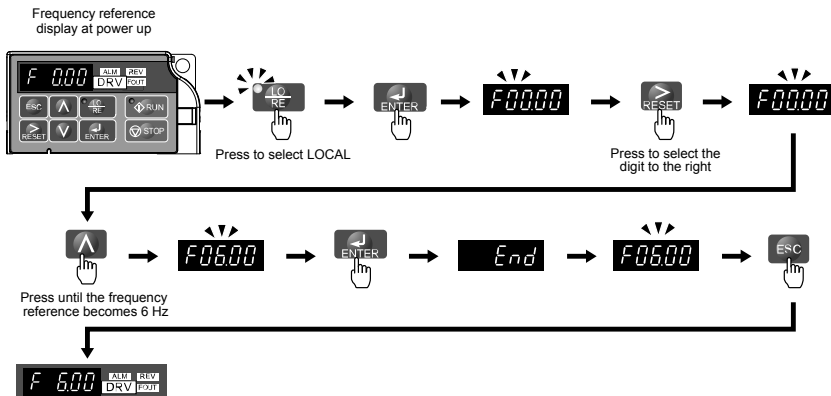


Figure 4.4 Setting the Frequency Reference while in Drive Mode

**Note:** The drive will not accept a frequency reference set value unless the ENTER key is pressed after the frequency reference is entered. This feature prevents accidental setting of the frequency reference. By setting o2-05 (Frequency Reference Setting Method Selection) to 1 (Enabled), the drive will accept the frequency reference while it is being adjusted on the digital operator.

### ■ Programming Mode Details

The following actions are possible in the programming mode:

- **Verify Function:** Verify parameter setting changes from original default values.
- **Setup Group:** Access a list of commonly used parameters to simplify setup.
- **Parameter Setting Mode:** Access and edit all parameter settings.

#### The Setup Group within the Programming Mode

In Setup Group, the user can access the minimum group of parameters required to operate the application.

**Note:** Setup Group parameters are listed in [Table 4.4](#).

[Figure 4.5](#) illustrates the keys to press to enter the Setup Group.

In this example, the source of the frequency reference is changed from the control circuit terminals to the LED Operator (i.e., b1-01 is changed from 1 to 0).

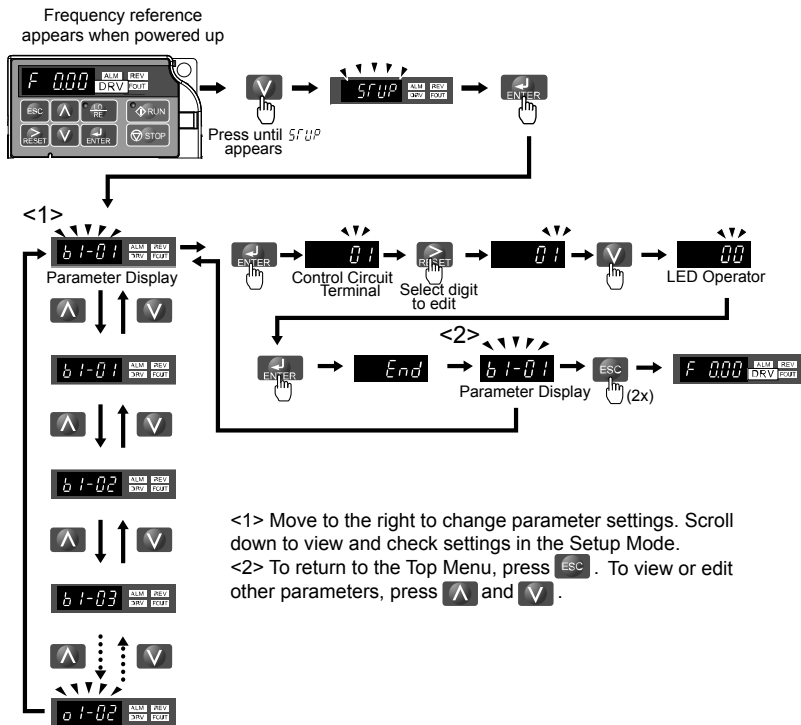

















Figure 4.5 Setup Group Example

## ◆ Changing Parameter Settings or Values

This example explains changing C1-01 (Acceleration Time 1) from 10.0 seconds (default) to 20.0 seconds.

Step		Display/Result
1.	Turn on the power to the drive. The initial display appears.	
2.	Press the <b>▲</b> key until the Setup Mode Screen appears.	

### 4.3 The Drive and Programming Modes

Step			Display/Result
3.	Press the  key to view the parameter setting display.	→	
4.	Scroll through parameters by pressing the  key until C1-01 appears.	→	
5.	Press  to view the current setting value (10.0). (Number farthest to the left flashes)	→	
6.	Press  until the desired number is selected. ("1" flashes)	→	
7.	Press the  key and enter 0020.0.	→	
8.	Press  and the drive will confirm the change.	→	
9.	The display automatically returns to the screen shown in Step 4.	→	
10.	Press the  key until back at the initial display.	→	




#### ◆ Verifying Parameter Changes: Verify Menu








The Verify Menu lists edited parameters from the Programming Mode. The Verify Menu helps determine which settings have been changed, and is particularly useful when replacing a drive. If no settings have been changed the Verify Menu will read *nonE*. The Verify menu also allows users to access and re-edit edited parameters.

**Note:** The Verify Menu will not display parameters from the A1 group even if those parameters have been changed from default settings.

The following example is a continuation of the steps beginning on page 83. Here, parameter C1-01 is accessed using the Verify Menu and is changed again to 20.0 s.

To check the list of edited parameters:

Step			Display/Result
1.	Turn on the power to the drive. The initial display appears.	→	
2.	Press  until the display shows the "Verify" representation.	→	

Step			Display/Result
3.	Press  to enter the list of parameters that have been edited from their original default settings. Scroll through the list by pressing the  key.	➔	
4.	Press the  key until C1-01 appears.	➔	
5.	Press the  key to access the setting value. (number farthest to the left flashes)	➔	

### ◆ Switching Between LOCAL and REMOTE






Entering the run command using the LED operator is referred to as LOCAL, while entering the run command from an external device via the control circuit terminals or network option is referred to as REMOTE.

**WARNING! Sudden Movement Hazard.** The drive may start unexpectedly if the Run command is already applied when switching from LOCAL mode to REMOTE mode when b1-07 = 1, resulting in death or serious injury. Be sure all personnel are clear of rotating machinery and electrical connections prior to switching between LOCAL mode and REMOTE mode.

There are two ways to switch between LOCAL and REMOTE.

- Note:**
1. After selecting LOCAL, the LO/RE light will remain lit.
  2. The drive will not allow the user to switch between LOCAL and REMOTE during run.

### ■ Using the LO/RE Key on the LED Operator

Step			Display/Result
1.	Turn on the power to the drive. The initial display appears.	➔	
2.	Press  . The LO/RE light will light up. The drive is now in Local. To set the drive for REMOTE operation, press the  key again.	➔	 

## 4.3 The Drive and Programming Modes

### ■ Using Input Terminals S1 through S5 to Switch between LO/RE

Switch between LOCAL and REMOTE using one of the digital input terminals S1 through S5 (set the corresponding parameter H1-01 through H1-05 to “1”).

Follow the example below to set the digital input terminals.

- Note:**
1. For a list of digital input selections, *Refer to Parameter List on page 213.*
  2. Setting a multi-function input terminal to a value of 1 disables the LO/RE key on the LED operator.

## ◆ Parameters Available in the Setup Group

### ■ Setup Mode (STUP)

Parameters used for this drive are classified into A to U. To simplify the drive setup, frequently used parameters are selected and input into Setup Mode.

1. To set a parameter, the Setup Mode must be displayed first. Press the Up/Down key until *STUP* is displayed.
2. Select the parameter and change the setting. [Table 4.4](#) lists parameters available in the Setup group. If the desired parameter cannot be set in the Setup mode, use the Parameter Setting mode.

**Table 4.4 Setup Group Parameters**

Parameter	Name	Parameter	Name
b1-01	Frequency Reference Selection	d1-17	Jog Frequency Reference
b1-02	Run Command Selection	E1-01	Input Voltage Reference
b1-03	Stop Method Selection	E1-04	Maximum Output Frequency
C1-01	Acceleration Time 1	E1-05	Maximum Voltage
C1-02	Deceleration Time 1	E1-06	Base Frequency
C6-01	Drive Duty Selection	E1-09	Minimum Output Frequency
C6-02	Carrier Frequency Selection	E2-01	Motor Rated Current
d1-01	Frequency Reference 1	H4-02	Terminal AM Gain Setting
d1-02	Frequency Reference 2	L1-01	Motor Protection Function Selection
d1-03	Frequency Reference 3	L3-04	Stall Prevention Selection during Deceleration
d1-04	Frequency Reference 4		

## 4.4 Start-up Flowchart

This section summarizes the basic steps required to start the drive. The flowchart is intended as a quick reference to help familiarize the user with start-up procedures.

### ◆ Flowchart: Basic Start-up

*Figure 4.6* describes basic start-up sequence for the drive and motor system. This sequence varies slightly depending on application. Use drive default parameter settings in simple applications that do not require high precision.

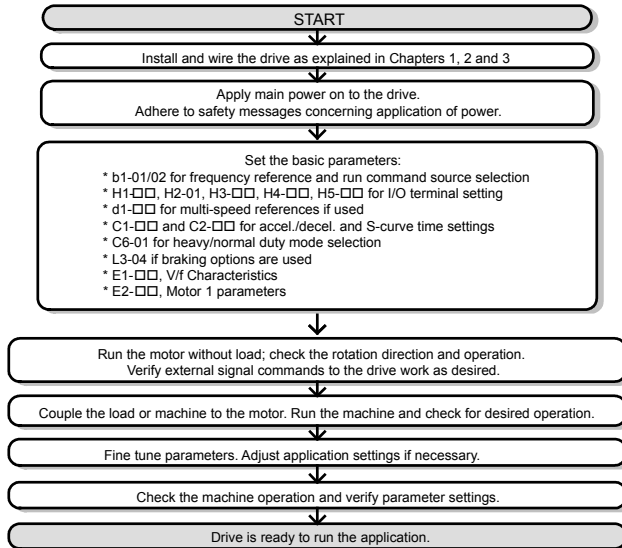


Figure 4.6 Basic Start-Up

# 4.5 Basic Operation

This section explains the basic settings required for initial drive operation. Checking these basic parameter settings during start-up will help to ensure a successful drive start-up.

If more information is required for parameters not listed in this section, [Refer to Parameter List on page 213](#) as required for a complete listing of drive parameters.

---

## ◆ Initialize Parameter Values: A1-03

Parameter A1-03 (Initialize Parameters) resets all parameters to the original default values.

**Note:** Record all the changed settings before initializing parameters.

## ■ Different Methods of Drive initialization

### 2220: 2-Wire Initialization

Returns all parameters to factory default values for 2-wire control. A 2-Wire sequence assigns functions to input terminals S1 and S2.

### 3330: 3-Wire Initialization

Returns all parameters to factory default values for 3-wire control. A 3-Wire sequence assigns functions to input terminals S1, S2, and S5.

---

## ◆ Frequency Reference Source: b1-01

This section explains how to assign the frequency reference. Parameters b1-01 and b1-02 can be used to select the source of the run command and the frequency reference independently (e.g., set the reference from the operator and set the run command from the terminals).

## ■ Frequency Reference from the LED Operator: b1-01 = 0

When b1-01 = 0 the frequency reference will be provided by the LED operator. [Refer to The Drive and Programming Modes on page 79](#) for information on how to set the frequency reference.

## ■ Frequency Reference from the Analog Input Terminal: b1-01 = 1

When b1-01 = 1, analog input A1 provides the frequency reference.

**Note:** Set H3-01 (Terminal A1 Function Selection) to “0” to configure Terminal A1 for the main analog frequency reference.

### Voltage Input

When entering the frequency reference with a voltage signal, set parameter H3-01 to “0” for 0 to 10 Vdc with lower reference limit. Set H3-01 to “1” if 0 to 10 Vdc input without lower limit is required. Set DIP Switch S1 for voltage input (position “V”).



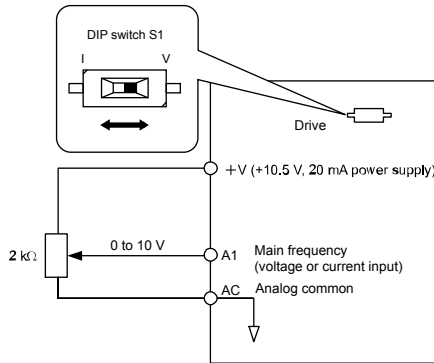


Figure 4.7 Voltage Input for the Frequency Reference

**Current Input**

When entering the frequency reference using an analog input signal, set parameter H3-01 to “2” if 4 to 20 mA input is used. When using 0 to 20 mA input, set H3-01 to “3”. Set DIP Switch S1 for current input (position “I”).

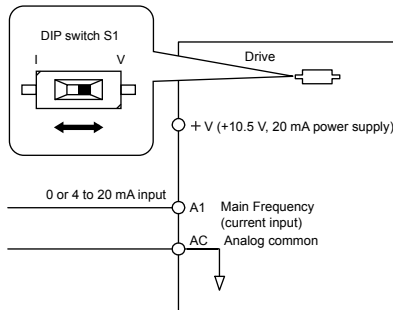


Figure 4.8 Current Input for the Frequency Reference

## 4.5 Basic Operation

### ◆ Run Command Input Selection: b1-02

This section explains how to assign the run command input.

Parameters b1-01 and b1-02 can be used to select the source of the run command and the frequency reference independently, e.g. set the reference from the operator and set the run command from the terminals.


**WARNING! Sudden Movement Hazard.** Clear personnel, secure equipment, and check sequence and safety circuitry before starting the drive. Failure to comply could result in death or serious injury from moving equipment.




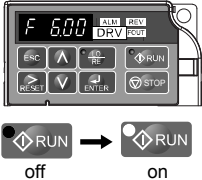

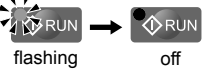
### ■ Run the Drive at 6 Hz using the LED Operator: b1-02 = 0

To assign the run command to the operator panel, set parameter b1-02 to “0”. This will set up the drive to acknowledge the run command through the LED operator. Initialize the run command using the Run and Stop keys. Upon power up, the drive uses parameter b1-02 to determine the run command location.

The following procedure indicates how to start and stop the drive through the LED operator after parameter b1-02 has been set to 0.

**Note:**

When b1-02 (Run Command Selection) is not set to 0 (operator), press  to set LOCAL.

Step		Display/Result
1.	Turn on the power to the drive. The initial display appears.	
2.	Set the frequency reference to F6.00 (6 Hz). <b>Note:</b> <a href="#">Refer to Drive Mode Details on page 81</a> for instructions on how to set the frequency reference.	
3.	Press the  key to start the motor.	
4.	The motor should accelerate up to 6 Hz while the RUN light is on.	
5.	Press the  key to stop the motor. The RUN light will flash until the motor comes to a complete stop.	

## ■ Run the Drive using Digital Input Terminals: b1-02 = 1

This setting uses the digital input terminals to enter the run command. The factory setting is a 2-Wire sequence.

### Using a 2-Wire Sequence

Digital Input Terminals	ON	OFF
S1	Forward Run	Stop
S2	Reverse Run	Stop

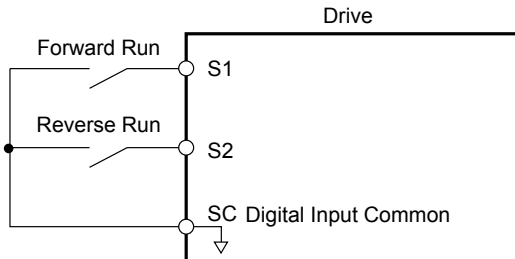


Figure 4.9 Example Wiring Diagram for 2-Wire Sequence

### Using a 3-Wire Sequence

When H1-05 (Multi-Function Digital Input Terminal S5 Function Selection) = 0, the functions of terminals S1 and S2 are set to 3-Wire sequence, and the multi-function input terminal becomes forward/reverse run command terminal.

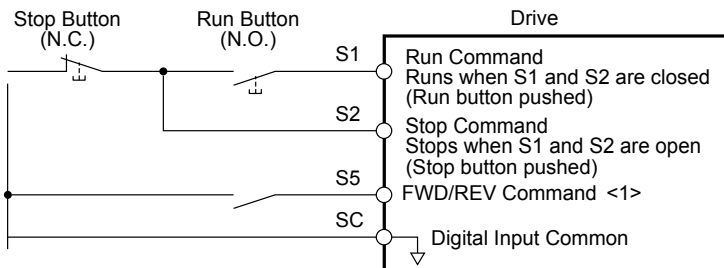


Figure 4.10 Example Wiring Diagram for 3-Wire Sequence Using Terminal S5

## 4.5 Basic Operation

<1> When terminal S5 is open, the motor rotates forward. When closed, the motor rotates in reverse.

**WARNING!** When 3-Wire sequence is used, set the drive to 3-Wire sequence before wiring the control terminals and ensure parameter b1-17 is set to 0 (drive does not accept a run command at power up (default)). If the drive is wired for 3-Wire sequence but set up for 2-Wire sequence (default) and if parameter b1-17 is set to 1 (drive accepts a Run command at power up), the motor will rotate in reverse direction at power up of the drive and may cause injury.

- Note:** Refer to [Parameter List on page 213](#) for a list of digital input functions. After performing a 3-Wire initialization (A1-03 = "3"), the drive will automatically assign the forward/reverse command to terminal S5.
- Note:** Run by Turning on/off the Power Supply. For safety reasons, the drive is initially set up not to accept a run command at power up (b1-17 = "0"). If a run command is issued at power up, the RUN indicator LED will flash quickly. To change this and have the run command issued by the drive, change parameter b1-17 to 1.

### ◆ Stopping Method Selection: b1-03

When a Stop command is issued, the drive stops the motor using one of two possible methods.

#### ■ Ramp to Stop: b1-03 = 0

When b1-03 = 0, the motor will decelerate to a stop when a stop command is entered. The deceleration time is set by C1-02 (Deceleration Time 1). [Refer to Acceleration/Deceleration: C1-01 to C1-04 on page 93.](#)

When the output frequency falls below E1-09 (Minimum Output Frequency) during deceleration, the DC Injection braking current (b2-02) will be activated for the specified DC Injection time at stop (b2-04).

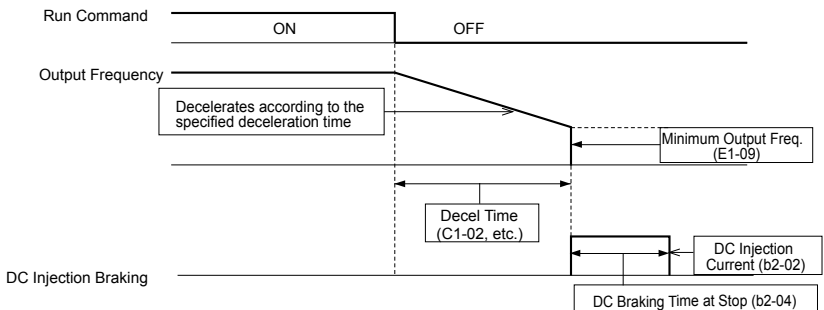


Figure 4.11 Ramp to Stop

## ■ Coast to Stop: b1-03 = 1

When the run command is removed, the drive will shut off its output and the motor will coast (uncontrolled deceleration). The motor will coast to a stop at the rate determined by the load inertia.

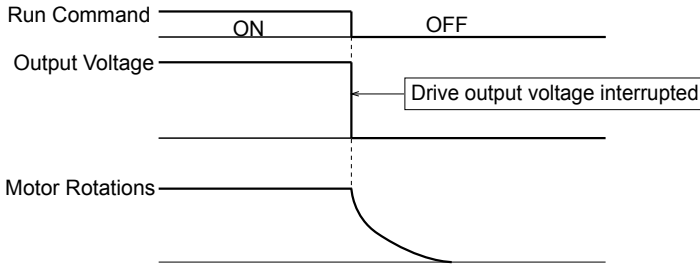


Figure 4.12 Coast to Stop

- Note:**
1. After entering a stop command, the drive will not accept another run command until the time set passes.
  2. Do not enter another run command until the motor comes to a complete stop. If a run command must be entered before the motor has fully stopped, use DC Injection to slow the motor or catch the motor before restarting.

## ◆ Acceleration/Deceleration: C1-01 to C1-04

C1-01 (Acceleration Time 1) sets the time to accelerate from 0 to the maximum output frequency (E1-04). C1-02 (Deceleration Time 1) sets the time to decelerate from maximum output frequency to 0.

No.	Parameter Name	Description	Setting Range	Default
C1-01 </>	Acceleration Time 1	Sets the time to accelerate from 0 to 100% (maximum output frequency).	0.0 to 6000.0	10.0 s
C1-02 </>	Deceleration Time 1	Sets the time to decelerate from 100% (maximum output frequency) to 0%.		

<1> The parameter can be changed during run.

**WARNING!** Sudden Movement Hazard. Rapid deceleration may cause the drive to fault on an overvoltage condition, resulting in death or serious injury due to an uncontrolled motor state. Set an acceptable deceleration time in parameter C1-09 when using the Fast-stop feature.

## 4.5 Basic Operation

### Switching Accel/Decel Times with Digital Input Terminals

Two acceleration / deceleration times can be selected using one of the digital input terminals S1 through S5.

Program one of the parameters H1-01 through H1-05 to “07” (Accel/Decel Time). Opening or closing the digital input changes the accel/decel times as shown below:

Accel/Decel Time H1-□□ = 7	Acceleration Time	Deceleration Time
Open (not selected)	C1-01	C1-02
Closed	C1-03	C1-04

### Using S-Curve Characteristics during Acceleration/Deceleration

Use S-curve characteristics to smooth acceleration and deceleration and to minimize abrupt shock to the load.

**Note:** Setting S-curve characteristics will lengthen accel/decel times as follows:

$$\text{Accel Time} = \text{Selected Accel Time} + (C2-01 + C2-02)/2$$

$$\text{Decel Time} = \text{Selected Decel Time} + (C2-03 + C2-04)/2$$

#### Setting Example

*Figure 4.13* illustrates S-curve characteristics switching between forward and reverse.

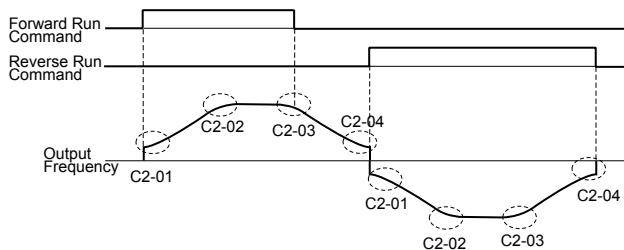


Figure 4.13 S-Curve Characteristics

## ◆ Drive Duty and Carrier Frequency Selection: C6-01 and C6-02

### ■ Drive Duty Selection: C6-01

The drive has two different duty modes from which to select based on the load characteristics. The drive rated current, overload capacity, and carrier frequency will change depending upon the duty mode selection. Use parameter C6-01 (Duty Cycle) to select Heavy Duty (HD) or Normal Duty (ND) for the application. The default setting is ND. *Refer to Specifications on page 199* for details about the rated current.

#### HD and ND Mode Selections

Mode	HD Rating	ND Rating
C6-01	0	1
Characteristics		
Application	Use HD Rating is designed applications requiring a high overload tolerance with constant load torque, like conveyors.	Use ND Rating for applications in which the torque requirements drop along with the speed. Examples include fans or pumps where a high overload tolerance is not required.
Overload capability (oL2)	100% continuous, 150% of drive rated current for 60 s	100% continuous, 120% of drive rated current for 60 s
C6-02	2.0 to 15.0 kHz (default depends on drive capacity)	
L3-02 Stall Prevention during Acceleration	150%	120%
L3-06 Stall Prevention during Run	150%	120%

- Note:**
1. By selecting HD/ND, motor parameter E2 is changed to the value for the maximum applicable motor.
  2. Swing PWM uses 2.0 kHz carrier frequency as a base. The application of special PWM patterns keeps the audible noise of the motor low.

## 4.5 Basic Operation

### ■ Carrier Frequency Selection: C6-02

#### Fixed Carrier Frequencies

The carrier frequency can be set using parameter C6-02 as shown in table below.

Parameter	Name	Description	Setting Range	Default
C6-02	Carrier frequency	1 : 2.0 kHz 2 : 5.0 kHz 3 : 8.0 kHz 4 : 10.0 kHz 5 : 12.5 kHz 6 : 15.0 kHz 7 : Swing PWM F : User defined (C6-03 to C6-05)	1 to F	Depends on drive size

**Note:** Settings 7 through A for parameter C6-02 use a Swing PWM equivalent to a 2 kHz audible noise. This function turns the motor noise into a less obtrusive white noise.

**Note:** The upper limit for the carrier frequency is determined by drive capacity.

Precautions when setting parameter C6-02:

Symptom	Possible Solution
Speed and torque are unstable at low speeds.	Lower the carrier frequency.
Noise from the drive is affecting peripheral devices.	
Excessive leakage current from the drive.	
Wiring between the drive and motor is too long. <I>	
Motor acoustic noise is too loud.	Increase the carrier frequency or use Swing PWM.

<I> The carrier frequency may need to be lowered if the motor cable is too long. Refer to the table below.

Wiring Distance	Up to 50 m	Up to 100 m	Greater than 100 m
C6-02 (Carrier Frequency Selection)	1 to F (15 kHz)	1 to 2 (5 kHz), 7	1 (2 kHz), 7

#### Carrier Frequency Setting Error (oPE11)

A carrier frequency setup error (oPE11) will occur when carrier frequency gain (C6-05) is greater than 6 and C6-03 < C6-04.

**Note:** Refer to *Troubleshooting without Fault Display on page 151* for information on operator errors (oPE).

### ■ Carrier Frequency and Drive Overload Current Level

The tables below show the drive output current depending on the carrier frequency settings. The 2 kHz value is equal to the Normal Duty (C6-01 = 1) rated current, the 8/10 kHz value is equal to the Heavy Duty rated current. The carrier frequency determines the output current linearly. Use the data below to calculate output current values for carrier frequencies not listed in the tables.

**Note:** In Heavy Duty mode the maximum rated output current is equal to the 8/10 kHz value, even if the carrier frequency is reduced.



Table 4.5 Drives with Heavy Duty Default Carrier Frequency of 10 kHz

200 V Single Phase Units				200 V Three Phase Units			
Drive Model	Rated Current [A]			Drive Model	Rated Current [A]		
	2 kHz	10 kHz	15 kHz		2 kHz	10 kHz	15 kHz
BA0001	1.2	0.8	0.6	2A0001	1.2	0.8	0.6
BA0002	1.9	1.6	1.3	2A0002	1.9	1.6	1.3
BA0003	3.5	3.0	2.4	2A0004	3.5	3.0	2.4
BA0006	6.0	5.0	4.0	2A0006	6.0	5.0	4.0

Table 4.6 Drives with Heavy Duty Default Carrier Frequency of 8 kHz

200 V Single Phase Units				200 V Three Phase Units				400 V Three Phase Units			
Drive Model	Rated Current [A]			Drive Model	Rated Current [A]			Drive Model	Rated Current [A]		
	2 kHz	8 kHz	15 kHz		2 kHz	8 kHz	15 kHz		2 kHz	8 kHz	15 kHz
BA0010	9.6	8.0	6.4	—	—	—	—	4A0001	1.2	1.2	0.7
—	—	—	—	2A0010	9.6	8.0	6.4	4A0002	2.1	1.8	1.1
—	—	—	—	2A0012	12.0	11.0	8.8	4A0004	4.1	3.4	2.0
—	—	—	—	—	—	—	—	4A0005	5.4	4.8	2.9
—	—	—	—	2A0020	19.6	17.5	14.0	4A0007	6.9	5.5	3.3
—	—	—	—	—	—	—	—	4A0009	8.8	7.2	4.3
—	—	—	—	—	—	—	—	4A0011	11.1	9.2	5.5

## ◆ Multi-Step Speed Operation (4-Step Speed)

Select up to 9 preset references (including Jog reference) using two multi-function inputs S4 and S5. Two multi-step references can be selected using two multi-function inputs as illustrated in [Figure 4.14](#).

### ■ Multi-Step Speed Operation Parameters

No.	Name	Description
d1-01	Frequency Reference 1	Frequency reference. o1-03 determines the units, with Hz as the default.
d1-02	Frequency Reference 2	Frequency reference when multi-function input “Multi-Step Speed Reference 1” (H1-□□ = 3) is on. Setting unit: set by o1-03.
d1-03	Frequency Reference 3	Frequency reference when multi-function input “Multi-Step Speed Reference 2” (H1-□□ = 4) is on. Setting unit: set by o1-03.
d1-04	Frequency Reference 4	Frequency reference when multi-function input “Multi-Step Speed Reference 1, 2” (H1-□□ = 3 and 4) are both on. Setting unit: set by o1-03.

## 4.5 Basic Operation

### ■ Digital Input

Terminal	Parameter	Setting	Contents
S4	H1-04	4	Multi-Step Speed Reference 2
S5	H1-05	3	Multi-Step Speed Reference 1

### ■ Wiring Example

Set up external switches SW1 and SW2.

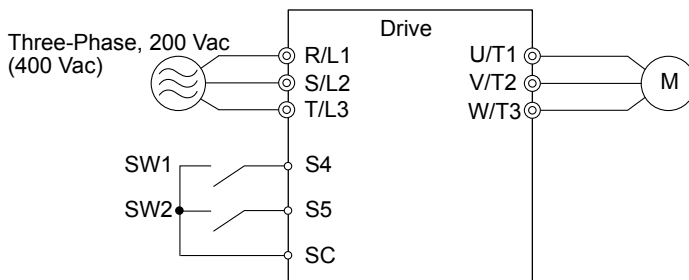


Figure 4.14 Control Terminals for 4 Multi-Step Speeds

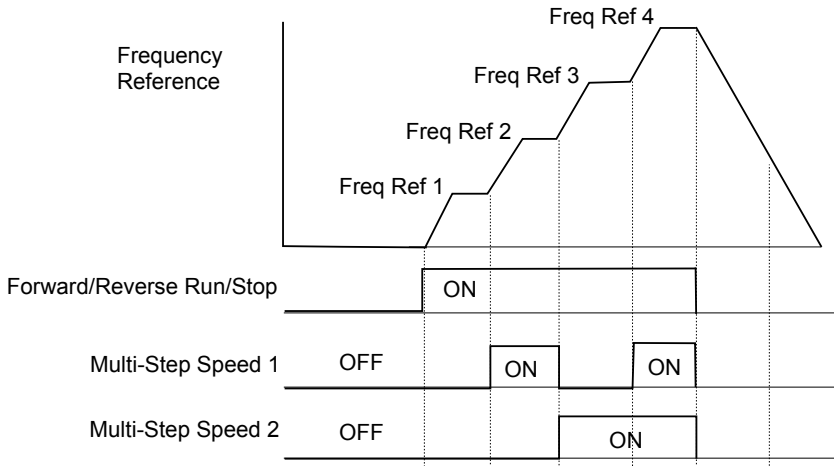






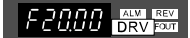







Figure 4.15 4-Step Speed Time Chart

### Setting Procedure

Step			Display/Result
1.	Turn on the power to the drive. The initial display appears.	➔	F 000 ALM REV DRV CUT
2.	Set the frequencies listed below to the specified parameters: 1. d1-01 = 5 Hz: Step 1 </> 2. d1-02 = 20 Hz: Step 2 3. d1-03 = 50 Hz: Step 3 4. d1-04 = 60 Hz: Step 4		
3.	Press the <b>ESC</b> key until the initial display appears.		F 000 ALM REV DRV CUT
4.	<b>DRV</b> turns on.	➔	F 000 ALM REV DRV CUT

## 4.5 Basic Operation

Step		Display/Result
5.	Press  to select LOCAL. The LO/RE light will turn on.	 
6.	Press  to run the motor at 5 Hz. The RUN light will turn on.	  Off → On
7.	With SW1 closed, the drive runs the motor at Multi-Step Speed 2 (20 Hz).	
8.	With SW1 open and SW2 closed, the drive runs the motor at Multi-Step 3 (50 Hz).	
9.	With both SW1 and SW2 closed, the drive runs the motor at Multi-Step 4 (60 Hz).	
10.	Press  to stop the drive. The RUN light will flash until the motor comes to a complete stop.	  Flashing → Off

<1> When the frequency reference is assigned to the LED operator (b1-01=0), the first step in a multi-step speed sequence comes from d1-01.

**Note:** When a run command is input from the control circuit terminal, the frequency reference value is selected as follows:  
 When b1-01 = 0 and the run command is given, the drive uses the frequency set to d1-01.  
 When b1-01 = 1 and the run command is given, the drive uses the frequency reference value input to analog control terminal A1.

## ◆ E1: V/f Characteristics

### ■ E1-01: Input Voltage Setting

Set the input voltage parameter to the nominal voltage of the AC power supply. This parameter adjusts the levels of some protective features of the drive (overvoltage, Stall Prevention, etc.).

**NOTICE:** Set parameter E1-01 to match the input voltage of the drive. Drive input voltage (not motor voltage) must be set in E1-01 for the protective features of the drive to function properly. Failure to comply could result in improper drive operation.

No.	Parameter Name	Setting Range	Default
E1-01 </>	Input Voltage Setting	155 to 255 V	230 V

</> The setting range and default value shown here are for 200 V class drives. Double this for 400 V class units.

#### E1-01 Related Values

The input voltage setting determines the over-/undervoltage detection level and the operation levels of the braking transistor.

Voltage	Setting Value of E1-01	(Approximate Values)		
		ov Detection Level	BTR Operation Level	Uv Detection Level
200 V Class	All settings	410 V	394 V	190 V (single-phase = 160 V)
400 V Class	Setting $\geq$ 400 V	820 V	788 V	380 V
	Setting < 400 V	740 V	708 V	350 V

**Note:** The braking transistor operation levels are valid for the drive internal braking transistor. If an external CDBR braking chopper is used, refer to the instruction manual of that unit.

### ■ V/f Pattern Settings

The drive utilizes a set V/f pattern to determine the appropriate output voltage level for each relative to the frequency reference.

#### V/f Pattern Setup for V/f Control

1. Set the input voltage for the drive. Refer to E1-01: Input Voltage Setting on page [222](#).
2. Set the V/f pattern. Refer to V/f Pattern Settings E1-04 to E1-10 on page [222](#).

## 4.5 Basic Operation

### ■ V/f Pattern Setting Examples

This section provides examples of how to set a V/f pattern using E1-04 to E1-10.

**Table 4.7 V/f Pattern Examples**

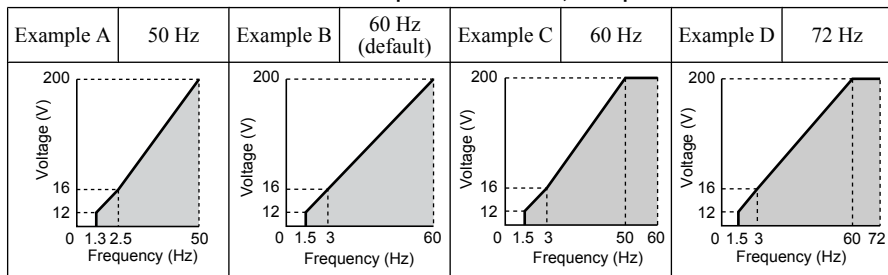
Example	Specification	Characteristic	Application
A	50 Hz	Constant torque	For general purpose applications. Torque remains constant regardless of changes to speed.
B	60 Hz (default setting)		
C	60 Hz (with 50 Hz base)		
D	72 Hz (with 60 Hz base)		
E	50 Hz, Heavy Duty 2	Derated torque	For fans, pumps, and other applications that require torque derating relative to the load.
F	50 Hz, Heavy Duty 1		
G	50 Hz, Heavy Duty 1		
H	50 Hz, Heavy Duty 2		
I	50 Hz, mid starting torque	High starting torque	Select high starting torque when: <ul style="list-style-type: none"> <li>• Wiring between the drive and motor exceeds 150 m</li> <li>• A large amount of starting torque is required</li> <li>• An AC reactor is installed</li> </ul>
J	50 Hz, high starting torque		
K	60 Hz, mid starting torque		
L	60 Hz, high starting torque		
M	90 Hz (with 60 Hz base)	Constant output	When operating at greater than 60 Hz the output voltage will be constant.
N	120 Hz (with 60 Hz base)		
O	180 Hz (with 60 Hz base)		

The following tables show details on V/f patterns.

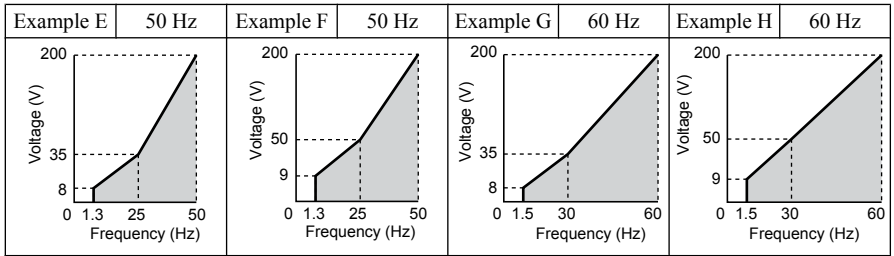
The following graphs are for 200 V class drives. Double the values when using a 400 V class drive.

### V/f Pattern Examples

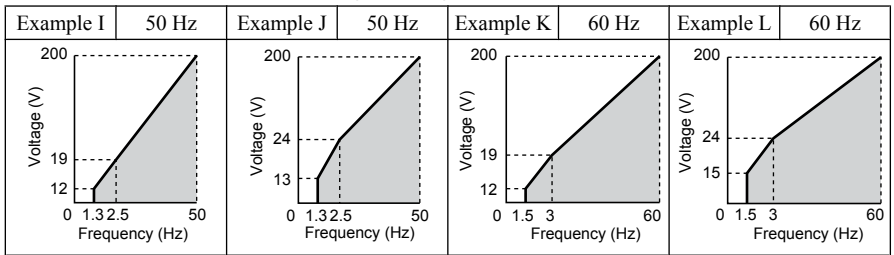
**Table 4.8 Constant Torque Characteristics, Examples A to D**



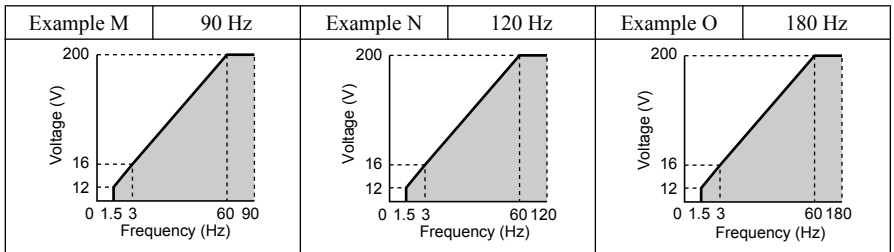
**Table 4.9 Derated Torque Characteristics, Examples E to H**



**Table 4.10 High Starting Torque, Examples I to L**



**Table 4.11 Rated Output Operation, Examples M to O**



### ■ V/f Pattern Settings E1-04 to E1-10

Set up the V/f pattern as shown in [Figure 4.16](#).

No.	Parameter Name	Setting Range	Default
E1-04	Maximum Output Frequency	40.0 to 400.0 Hz	60 Hz
E1-05	Maximum Voltage	0.0 to 255.0 V <>	230 V
E1-06	Base Frequency	0.0 to 400.0 Hz	60 Hz

## 4.5 Basic Operation

No.	Parameter Name	Setting Range	Default
E1-07	Middle Output Frequency	0.0 to 400.0 Hz	3.0 Hz
E1-08	Middle Output Frequency Voltage	0.0 to 255.0 V </>	18.4 V
E1-09	Minimum Output Frequency	0.0 to 400.0 Hz	1.5 Hz
E1-10	Minimum Output Frequency Voltage	0.0 to 255.0 V </>	13.8 V

< /> Values shown here are for 200 V class drives; double the values for 400 V class drives.

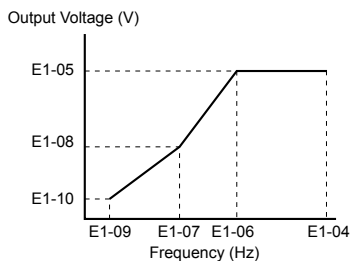


Figure 4.16 V/f Pattern

- Note:**
1. The following condition must be true when setting up the V/f pattern:  $E1-09 \leq E1-07 < E1-06 \leq E1-04$
  2. To make the V/f pattern a straight line set  $E1-09 = E1-07$ . In this case the  $E1-08$  setting is disregarded.
  3.  $E1-03$  is unaffected when the drive is initialized using parameter  $A1-03$ , but the settings for  $E1-04$  through  $E1-10$  are returned to their default values.

## ◆ Motor Parameters: E2-01 to E2-03

### ■ Setting Motor Parameters

The following table provides instructions on how to set motor parameters. Refer to the motor data sheet for the correct motor data.

No.	Parameter Name	Setting Method
E2-01	Motor Rated Current	Sets the motor nameplate full load current in amperes (A).
E2-02	Motor Rated Slip	Calculate and set the motor rated slip based on the rated speed described on the motor nameplate. Motor rated slip = Motor rated frequency [Hz] - Rated speed [r/min] x No. of motor poles / 120.



No.	Parameter Name	Setting Method
E2-03	Motor No-Load Current	Set motor no-load current at rated voltage and rated frequency. Contact the motor manufacturer to get the no-load current. This information is not usually written on the motor nameplate. The default no-load current is for a Yaskawa 4-pole motor.
E2-05	Motor Line-to-Line Resistance	Sets the phase-to-phase motor resistance in ohms.

## ◆ Digital Output: H2-01

Parameter H2-01 assigns functions to digital output terminals MA, MB, and MC. Set this parameter as required by the application. Default value is listed below.

**NOTICE:** Do not assign a function that repeats ON/OFF frequently to terminals MA and MB. Failure to comply will reduce the relay contact lifetime. The expected number of relay contact switching times is normally 200,000 times (current 1 A, resistance load).

No.	Parameter Name	Default
H2-01	Terminal MA, MB and MC Function Selection (relay)	E: Fault

**Note:** The setting range for H2-01 is 0 to 13D. *Refer to Parameter List on page 213* for more information.

Multi-Function Contact Outputs  
 250 Vac, 10 mA - 1 A  
 30 Vdc, 10 mA - 1 A  
 (standard default setting)

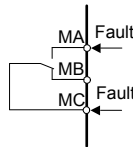


Figure 4.17 Digital Output Connection Diagram

## ◆ Analog Outputs: H4-01 to H4-03

Group U parameters can be used to observe the drive status (operating conditions) through the LED operator. Analog outputs corresponding to these monitors can be obtained on analog output terminal AM when programmed with parameter group H4. Some Group U monitors are not available as analog outputs.

## 4.5 Basic Operation

No.	Parameter Name	Description
H4-01	Terminal AM Monitor Selection	Select the data to output through multi-function analog output terminal AM. Set the desired monitor parameter to the digits available in U□-□□. For example, enter “103” for U1-03. When using this terminal as a through terminal or when not using it at all, set “000” or “031”.
H4-02 <1>	Terminal AM Output Gain	Sets the voltage level gain of terminal AM. The bias to be added ranges from 0 to +/- 10% when 10 V is assumed to be 100%.
H4-03 <1>	Terminal AM Bias Setting	Sets the voltage level bias for terminal AM. The bias added is 0 to ±10% with a maximum voltage output of 10 V as 100%.

<1> The parameter can be changed during run.

### ■ Changing Analog Output Settings






The following example illustrates how to program analog output terminal AM to generate a signal proportional to drive output current (monitor U1-03).

#### Using H4-01 to Display Monitor Contents

Step			Display/Result
1.	Turn on the power to the drive. The initial display appears.	➔	
2.	Press  until the Parameter setting menu is displayed.	➔	
3.	Press  to enter the Parameter setting menu.	➔	
4.	Press  and  to select H4-01.	➔	
5.	Press  to display the value currently set to H4-01.	➔	
6.	Press  and  to set the output current (103).	➔	
7.	Save the setting by pressing .	➔	
8.	The display automatically returns to the parameter setting menu.	➔	
9.	Press the  key until back at the Top Screen.	➔	

#### Adjusting the Analog Output Terminal Voltage with H4-02 and H4-03

**Note:** This example continues from Step 3 in the previous example.

Step			Display/Result
1.	Select H4-02 or H4-03 by pressing the  and  keys.	→	
2.	Press the  key while the drive is stopped and the following voltage is output for adjustment: Output voltage = (10 V x Output Gain (H4-02) + Output Bias (H4-03)). Using this output, adjust output gain (H4-02) and output bias (H4-03).	→	

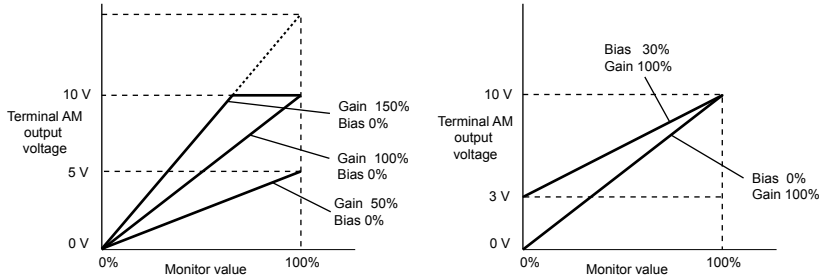


Figure 4.18 Analog Output Gain/Bias Setting

### ◆ Motor Protection: L1-01 and L1-02

This section explains how to set motor overload protection.

#### ■ Electronic Thermal Motor Protection

The drive has built-in electronic thermal overload protection to detect overload conditions. This protection meets standards set by UL and cUL for motor thermal overload protection. The protective feature is activated when the output current rises above the motor rated current for a specified time. This speed sensitive protective feature interrupts the motor current to protect the motor wiring and windings in the event of overload, eliminating the need for an external overload device. When multiple motors are used with a single drive, separate overload devices are required to properly protect the individual motor branches.

## 4.5 Basic Operation

### Related Parameters

No.	Parameter Name	Description	Setting Range	Default Setting
E2-01	Motor Rated Current	Sets the motor nameplate full load current in amperes (A). This set value becomes the reference value for motor protection, torque limit, and torque control.	10 to 200% of drive rated current	Determined by o2-04 and C6-01
L1-01	Motor Overload Protection Selection	Enables or disables motor thermal overload protection (oL1) 0: Disabled 1: Protection for general purpose motor 2: Protection for inverter motor	0 to 2	1
			Use L1-13 (Continuous Electrothermal Operation Selection) to select whether electronic thermal value is “held” or “not held” when the power supply is turned off. When connecting several motors to one drive, set “0” (disabled) and install a thermal relay on each motor.	
L1-02	Motor Overload Protection Time	Sets the electronic thermal overload protection detection time in the motor overload protection (oL1) function. This setting rarely needs to be changed and should be set in accordance with the overload tolerance of the motor.	0.1 to 20.0	8.0 min

**Note:** Executing C6-01 (Duty Cycle) changes motor parameters E2 including motor rated current to the values of the maximum applicable motor.

### Setting Procedure

1. Set E2-01 (Motor Rated Current) to the motor rated current.

Values set for the current become the base current for electronic thermal overload protection.

2. Set the proper motor protection level to L1-01.

The ability of the cooling fan to keep an induction motor cool varies by the speed control range. Protection characteristics of the electronic thermal overload protection should be set accordingly. Refer to [Table 4.12](#) for motor types and overload tolerances.

**NOTICE:** When connecting multiple motors to one drive, disable the electronic overload protection of the drive (L1-01 = 0) and protect each motor with its own motor thermal overload. Failure to comply could result in improper drive operation.

**NOTICE:** Inadequate motor protection could result in damage to the motor. Configure a motor thermal overload to disconnect main power to the drive when tripped. When using a thermal relay, disable the motor protection function (L1-01 = “0”).

Table 4.12 Motor Type and Overload Tolerances

L1-01 Setting	Motor Type	Overload Tolerance	Cooling Ability	Overload Characteristics
1	General-Purpose Motor (Standard Self-Cooled)		Motor designed to operate from line power. Motor cooling is most effective when running at rated nameplate base frequency (check the motor specifications).	Operating continuously at less than line power frequency can trigger motor overload protection (oL1). A fault is then output and the motor will coast to stop.
2	Drive Dedicated Motor (Constant Torque, 1:10)		Motor is designed to effectively cool itself at speeds as low as 6 Hz.	Continuous operation with 100% load from 6 Hz to 50/60 Hz.

Notes on Motor Protection

- Motor protection meeting UL and cUL standards is achieved with the motor overload protection time (L1-02) set to factory default setting. Normally, L1-02 (Motor Overload Protection Time) does not require setting. If the motor overload tolerance is clear, set the overload protection time at hot start according to the motor. To detect overload earlier, decrease the setting.

Figure 4.19 illustrates motor protection operation time characteristics.

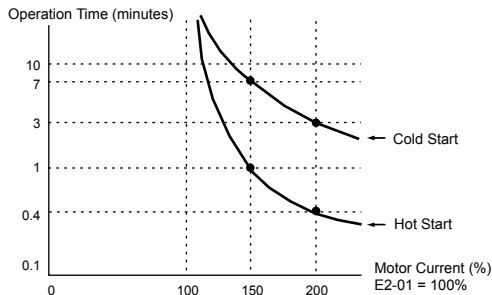


Figure 4.19 Motor Protection Operation

## 4.5 Basic Operation

- Disable motor protection (L1-01 = 1) when running multiple motors from the same drive. Attach a thermal relay for each motor to provide overload protection.
- Use L1-13 (Continuous Electrothermal Operation Selection) to select whether the electrothermal value is “held” or “not held” when power supply is turned off. Default setting is 1 (Enabled).
- In the case of a general purpose (standard) motor, the cooling capability is reduced at a low speed. Motor overload protection (oL1) may occur in frequencies lower than motor rated current. Use an exclusive-use or inverter-duty motor to operate the drive at rated current at low frequency.

### ◆ Drive Status Monitors: U1-01 to U4-13

Parameter group U displays various data regarding the operating status of the drive.

The following example demonstrates viewing output voltage reference (U1-06).

Step			Display/Result
1.	Turn on the power to the drive. The initial display appears.	➔	
2.	Press  until “Monitor Display” appears.	➔	
3.	Press  to enter the Parameter Setting Screen.	➔	
4.	Press  until U1-06 appears.	➔	
5.	Press  to display the voltage reference. The Output Voltage Reference appears.	➔	

*Refer to Parameter List on page 213* for more details about Drive Status Monitors.

**Table 4.13 Drive Status Monitors**

No.	Parameter Name	Page	No.	Parameter Name	Page
U1-01	Frequency Reference	<a href="#">235</a>	U1-19	MEMOBUS/Modbus Error Code	<a href="#">236</a>
U1-02	Output Frequency	<a href="#">235</a>	U1-25	Software Number (ROM)	<a href="#">236</a>
U1-03	Output Current	<a href="#">235</a>	U1-26	Software Number (Flash)	<a href="#">236</a>
U1-06	Output Voltage Reference	<a href="#">235</a>	U2-01	Current Fault	<a href="#">236</a>
U1-07	DC Bus Voltage	<a href="#">235</a>	U2-02	Previous Fault	<a href="#">236</a>
U1-10	Input Terminal Status	<a href="#">236</a>	U4-01	Accumulated Operation Time	<a href="#">237</a>
U1-11	Output Terminal Status	<a href="#">236</a>	U4-04	Cooling Fan Maintenance	<a href="#">237</a>
U1-13	Terminal A1 Input Voltage	<a href="#">236</a>	U4-05	Capacitor Maintenance	<a href="#">237</a>

## 4.5 Basic Operation

---

No.	Parameter Name	Page
U4-07	IGBT Maintenance	<a href="#">237</a>
U4-08	Heatsink Temperature	<a href="#">237</a>

No.	Parameter Name	Page
U4-09	LED Check	<a href="#">237</a>
U4-13	Peak Hold Current	<a href="#">237</a>

# 4.6 Powering Up the Drive

## ◆ Powering Up the Drive and Operation Status Display



### ■ Powering Up the Drive

Review the following checklist before turning the power on.

Item to Check	Description
Power supply voltage	Ensure the power supply voltage is correct: 200 V class: single-phase 200 to 240 Vac 50/60 Hz 200 V class: 3-phase 200 to 240 Vac 50/60 Hz 400 V class: 3-phase 380 to 480 Vac 50/60 Hz
	Properly wire the power supply input terminals (R/L1, S/L2, T/L3). (for single-phase 200 V class models, wire only R/L1 and S/L2)
	Check for proper grounding of drive and motor.
Drive output terminals and motor terminals	Properly wire drive output terminals U/T1, V/T2, and W/T3 with motor terminals U, V, and W.
Control circuit terminals	Check control circuit terminal connections.
Drive control terminal status	Open all control circuit terminals (off).
Status of the load and connected machinery	Uncouple the motor from the load.

### ■ Status Display

When the power supply to the drive is turned on, the LED operator lights will appear as follows:

No.	Name	Description
Normal Operation		The data display area displays the frequency reference. [DRV] is lit.
Fault	 Main circuit low voltage (ex)	Data displayed varies by the type of fault. <i>Refer to Fault Displays, Causes, and Possible Solutions on page 130</i> for more information and possible solution. [ALM] and [DRV] are lit.



### ◆ V/f Pattern Setting

Setting the V/f pattern according to the application. for details on setting the V/f pattern.

#### ■ Notes when Setting the V/f Pattern

Set the maximum output frequency to match the motor characteristics.

If the V/f pattern voltage is increased motor torque may also increase. However, if the V/f voltage is set too high these problems may occur:

- Excessive motor current.
- Motor overheat or vibration.

# 4.7 No-Load Operation Test Run

## ◆ No-Load Operation Test Run

This section explains how to operate the drive with the motor uncoupled from the load during a test run.

### ■ Before Starting the Motor

Check the following items before operation:

- Ensure the area around the motor is safe.
- Ensure external emergency stop circuitry is working properly and other safety precautions have been taken.

### ■ During Operation



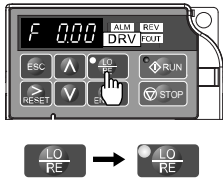
Check the following items during operation:

- The motor should rotate smoothly (i.e., no abnormal noise or oscillation).
- The motor should accelerate and decelerate smoothly.





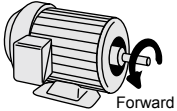





### ■ No-Load Operation Instructions

The following example illustrates a test run procedure using the digital operator.

**Note:** Before starting the motor, set the frequency reference d1-01 to 6 Hz.

Step		Display/Result
1.	Turn on the power to the drive. The initial display appears.	
2.	Press the  key to select LOCAL. The LO/RE LED will turn on.	

## 4.7 No-Load Operation Test Run

	Step		Display/Result
	<p>3. Press  to give the drive a Run command. RUN will light and the motor will rotate at 6 Hz.</p>	→	  Off →  On
	<p>4. Ensure the motor is rotating in the correct direction and no faults or alarms occur.</p>	→	<p>Motor</p>  <p>Forward</p>
	<p>5. If there is no error in step 4, press  to increase the frequency reference. Increase the frequency in 10 Hz increments verifying smooth operation results at all speeds. For each frequency, monitor the drive output current (U1-03) through the LED operator to confirm the current is well below the motor rated current.</p>		
	<p>6. The drive should operate normally. Press  to stop the motor. RUN flashes until the motor comes to a complete stop.</p>	→	  Flashing →  Off

# 4.8 Test Run with Load Connected

## ◆ Test Run with the Load Connected

After performing a no-load test run connect the load and proceed to run the motor and load together.

### ■ Notes on Connected Machinery

- Clear the area around the motor.
- The motor should come to a complete stop without problems.
- Connect the machinery.
- Fasten all installation screws properly. Check that the motor and connected machinery are held in place.
- Confirm that the Fast-stop circuit or mechanical safety measures operate correctly.
- Be ready to press the STOP button in case of emergency.

### ■ Checklist Before Operation

- The motor should rotate in the proper direction.
- The motor should accelerate and decelerate smoothly.

### ■ Operating the Motor under Loaded Conditions

Test run the application similarly to the no-load test procedure when connecting the machinery to the motor.

- Check monitor parameter U1-03 to ensure there is no overcurrent.
- If the application permits running the load in the reverse direction, try changing motor direction and the frequency reference while watching for abnormal motor oscillation or vibration.
- Correct any problems that occurs with hunting, oscillation, or other control-related issues.

## 4.9 Verifying and Backing Up Parameter Settings

Check changes to parameter settings using the Verify function. *Refer to Verifying Parameter Changes: Verify Menu on page 84.*

Save the verified parameter settings. Change the access level or set a password to the drive to prevent accidental modification of parameter settings.



### ◆ Parameter Access Level: A1-01

Setting the Access Level for “Operation only” (A1-01 = 0) allows the user to access parameters A1-□□ and U□-□□ only. Other parameters are not displayed.

No.	Parameter Name	Description	Setting Range	Default
A1-01	Access Level Selection	Selects which parameters are accessible via the digital operator. 0: Operation only (A1-01 and A1-04 can be set and monitored. U parameters can be monitored) 2: Advanced Access Level (All parameters can be set and monitored)	0, 2	2

### ◆ Password Settings: A1-04, A1-05

The user can set a password to the drive to restrict access. The password is selected via parameter A1-05. The selected password must be entered in parameter A1-04 to unlock parameter access (i.e., parameter setting A1-04 must match the value programmed into A1-05). The following parameters cannot be viewed or edited until the value programmed into A1-04 correctly matches the value as programmed in parameter A1-05: A1-01 and A1-03.

**Note:** Parameter A1-05 is hidden from view. To display A1-05, access parameter A1-04 and simultaneously depress the  key and the  key.

### ◆ Copy Function (Optional)

Parameter settings can be copied to another drive to simplify parameter restoration or multiple drive setup. The RS-232C Interface Unit (Removable Type) (SI-232/JC) is required to use the following options with J1000 drives:

#### ■ USB/Copy Unit (JVOP-181)

The copy unit is an external option connected to the drive to copy parameter settings to another drive. It includes a USB adapter to connect the drive to a PC.

## 4.9 Verifying and Backing Up Parameter Settings

---

### ■ LED Operator (JVOP-182)

The LED operator operates the drive and supports copying, importing, and verifying parameter settings.

**Note:** Use of the LED operator requires that the drive is running drive software version PRG: 1010 or later.

### ■ Drive Wizard Plus

Drive Wizard Plus is a PC software tool for parameter management, monitoring, and diagnosis. Drive Wizard Plus can load, store, and copy drive parameter settings. For details, refer to Help in the Drive Wizard Plus software.

The installation files can be obtained at no charge from:

U.S.: <http://www.yaskawa.com>


## 4.10 Test Run Checklist

Review the checklist before performing a test run. Check each item that applies.

<input checked="" type="checkbox"/>	No.	Checklist	Page
<input type="checkbox"/>	1	Thoroughly read the manual before performing a test run.	—
<input type="checkbox"/>	2	Turn the power on.	112
<input type="checkbox"/>	3	Set the voltage for the power supply to E1-01.	101

Check the items that correspond to the control mode being used.

**WARNING!** Ensure start/stop and safety circuits are wired properly and in the correct state before energizing the drive. Failure to comply could result in death or serious injury from moving equipment. When programmed for 3-Wire control, a momentary closure on terminal S1 may cause the drive to start.

<input checked="" type="checkbox"/>	No.	Checklist	Page
<input type="checkbox"/>	4	The <b>DRV</b> should illuminate after giving a run command.	—
<input type="checkbox"/>	5	To give a run command and frequency reference from the LED Digital Operator, press  to set to LOCAL. The LO/RE key lights while LOCAL is displayed.	85
<input type="checkbox"/>	6	If the motor rotates in the opposite direction during the test run, switch two of the drive output terminals (U/T1, V/T2, W/T3).	112
<input type="checkbox"/>	7	Select the correct duty rating (C6-01) for the application.	—
<input type="checkbox"/>	8	Set the correct values for the motor rated current (E2-01) and the motor protection selection (L1-01) to ensure motor thermal protection.	—
<input type="checkbox"/>	9	If the run command and frequency reference are provided via the control circuit terminals, set the drive for REMOTE and be sure the LO/RE light is out.	85
<input type="checkbox"/>	10	If the control circuit terminals should supply the frequency reference, select the correct voltage input signal level (0 to 10 V) or the correct current input signal level (4 to 20 mA or 0 to 20 mA).	85
<input type="checkbox"/>	11	Set the proper voltage to terminal A1. (0 to 10 V).	88
<input type="checkbox"/>	12	When current input is used, switch the drive built-in DIP switch S1 from the V-side (OFF) to I-side (ON).	—
<input type="checkbox"/>	13	Set the minimum and maximum frequency references to the desired values. Make the following adjustments if the drive does not operate as expected: Gain adjustment: Set the maximum voltage/current signal and adjust the analog input gain (H3-03) until the frequency reference value reaches the desired value. Bias adjustment: Set the minimum voltage/current signal and adjust the analog input bias (H3-04) until the frequency reference value reaches the desired minimum value.	—

**This Page Intentionally Blank**



# Troubleshooting

---

This chapter provides descriptions of the drive faults, alarms, errors, related displays, and possible solutions. This chapter can also serve as a reference guide for tuning the drive during a trial run.

<b>5.1</b>	<b>SECTION SAFETY.....</b>	<b>122</b>
<b>5.2</b>	<b>MOTOR PERFORMANCE FINE TUNING.....</b>	<b>125</b>
<b>5.3</b>	<b>DRIVE ALARMS, FAULTS, AND ERRORS.....</b>	<b>127</b>
<b>5.4</b>	<b>FAULT DETECTION.....</b>	<b>130</b>
<b>5.5</b>	<b>ALARM DETECTION.....</b>	<b>141</b>
<b>5.6</b>	<b>OPERATOR PROGRAMMING ERRORS.....</b>	<b>147</b>
<b>5.7</b>	<b>DIAGNOSING AND RESETTING FAULTS.....</b>	<b>149</b>
<b>5.8</b>	<b>TROUBLESHOOTING WITHOUT FAULT DISPLAY.....</b>	<b>151</b>

# 5.1 Section Safety

### DANGER

#### Electrical Shock Hazard

**Do not connect or disconnect wiring while the power is on.**

Failure to comply will result in death or serious injury.

### WARNING

#### Electrical Shock Hazard

**Do not operate equipment with covers removed.**

Failure to comply could result in death or serious injury.

The diagrams in this section may illustrate drives without covers or safety shields to display details. Be sure to reinstall covers or shields before operating the drives and run the drives according to the instructions described in this manual.

**Always ground the motor-side grounding terminal.**

Improper equipment grounding could result in death or serious injury by contacting the motor case.

**Do not touch terminals before the capacitors have fully discharged.**

Failure to comply could result in death or serious injury.

Before wiring terminals, disconnect all power to the equipment. The internal capacitor remains charged even after the drive input power is turned off. The charge indicator LED will extinguish when the DC bus voltage is below 50 Vdc. To prevent electric shock, wait at least one minute after all indicators are off and measure the DC bus voltage level to confirm safe level.

**Do not allow unqualified personnel to perform work on the drive.**

Failure to comply could result in death or serious injury.

Installation, maintenance, inspection and servicing must be performed only by authorized personnel familiar with installation, adjustment and maintenance of AC drives.

 **WARNING**

**Do not perform work on the drive while wearing loose clothing, jewelry, or without eye protection.**

Failure to comply could result in death or serious injury.

Remove all metal objects such as watches and rings, secure loose clothing and wear eye protection before beginning work on the drive.

**Do not remove covers or touch circuit boards while the power is on.**

Failure to comply could result in death or serious injury.

### **Fire Hazard**

**Tighten all terminal screws to the specified tightening torque.**

Loose electrical connections could result in death or serious injury by fire due to overheating of electrical connections.

**Do not use an improper voltage source.**

Failure to comply could result in death or serious injury by fire.

Verify that the rated voltage of the drive matches the voltage of the incoming drive input power before applying power.

**Do not use improper combustible materials.**

Failure to comply could result in death or serious injury by fire.

Attach the drive to metal or other noncombustible material.

### NOTICE

**Observe proper electrostatic discharge procedures (ESD) when handling the drive and circuit boards.**

Failure to comply may result in ESD damage to the drive circuitry.

**Never connect or disconnect the motor from the drive while the drive is outputting voltage.**

Improper equipment sequencing could result in damage to the drive.

**Do not use unshielded cable for control wiring.**

Failure to comply may cause electrical interference resulting in poor system performance. Use shielded twisted-pair wires and ground the shield to the ground terminal of the drive.

**Do not allow unqualified personnel to use the product.**

Failure to comply could result in damage to the drive or braking circuit.

Carefully review instruction manual TOBPC72060000 when connecting a braking option to the drive.

**Do not modify the drive circuitry.**

Failure to comply could result in damage to the drive and will void warranty.

Yaskawa is not responsible for modification of the product made by the user.

**Check all the wiring after installing the drive and connecting other devices to ensure that all connections are correct.**

Failure to comply could result in damage to the drive.

## 5.2 Motor Performance Fine Tuning

This section offers helpful information for counteracting oscillation, hunting, or other faults that occur while performing a trial run.

**Note:** This section describes parameters that are commonly edited. Consult Yaskawa for more information on detailed settings and fine-tuning the drive.

### ◆ Parameters for Tuning the Drive

Table 5.1 Parameters for Tuning the Drive

Problem	Parameter	Corrective Action	Default Value	Suggested Setting
<ul style="list-style-type: none"> <li>Motor hunting and oscillation at speeds between 10 and 40 Hz</li> </ul>	Hunting Prevention Gain (n1-02)	<ul style="list-style-type: none"> <li>If insufficient motor torque relative to the size of the load causes hunting, reduce the setting.</li> <li>When motor hunting and oscillation occur with a light load, increase the setting.</li> <li>Lower this setting if hunting occurs when using a motor with a relatively low inductance, such as a high-frequency motor or a motor with a larger frame size.</li> </ul>	1.00	0.00 to 2.00
<ul style="list-style-type: none"> <li>Motor noise</li> <li>Motor hunting and oscillation at speeds up to 40 Hz</li> </ul>	Carrier Frequency Selection (C6-02)	<ul style="list-style-type: none"> <li>If the motor noise is too loud, increase the carrier frequency.</li> <li>When motor hunting and oscillation occur at speeds up to 40 Hz, lower the carrier frequency.</li> <li>The default setting for the carrier frequency depends on the drive capacity (o2-04) and the Drive Duty Selection (C6-01).</li> </ul>	7 (Swing PWM)	1 to 7
<ul style="list-style-type: none"> <li>Poor motor torque at speeds below 10 Hz</li> <li>Motor hunting and oscillation</li> </ul>	Torque Compensation Gain (C4-01)	<ul style="list-style-type: none"> <li>If motor torque is insufficient at speeds below 10 Hz, increase the setting.</li> <li>If motor hunting and oscillation with a relatively light load, decrease the setting.</li> </ul>	1.00	0.50 to 1.50
<ul style="list-style-type: none"> <li>Poor motor torque at low speeds</li> <li>Motor instability at motor start</li> </ul>	Mid Output Voltage A (E1-08) Minimum Output Voltage (E1-10)	<ul style="list-style-type: none"> <li>If torque is insufficient at speeds below 10 Hz, increase the setting.</li> <li>If motor instability occurs at motor start, decrease the setting.</li> </ul> <p><b>Note:</b> The recommended setting value is for 200 V class drives. Double this value when using a 400 V class drive.</p>	E1-08: 18.4 V E1-10: 13.8 V	Initial value ±5 V
<ul style="list-style-type: none"> <li>Poor speed precision</li> </ul>	Slip Compensation Gain (C3-01)	<ul style="list-style-type: none"> <li>After setting the motor-rated current (E2-01), motor-rated slip (E2-02) and motor no-load current (E2-03), adjust the slip compensation gain (C3-01).</li> </ul>	-	0.5 to 1.5

**Note:** Use slip compensation to improve speed precision. First make sure that the proper values have been set for the motor rated current to E2-01, motor rated slip (E2-02), and motor no-load current (E2-03). Next, adjust the slip compensation gain set to C3-01 so that it is between 0.5 to 1.5.

## 5.2 Motor Performance Fine Tuning

---

### ◆ Motor Hunting and Oscillation Control Parameters

The following parameters indirectly affect motor hunting and oscillation.

**Table 5.2 Parameters that Affect Control Performance in Applications**

<b>Name (Parameter No.)</b>	<b>Application</b>
<b>Accel/Decel Time (C1-01 through C1-09)</b>	Adjusting accel and decel times will affect the torque presented to the motor during acceleration or deceleration.
<b>S-Curve Characteristics (C2-01 through C2-04)</b>	Prevents shock at the beginning and end of acceleration and deceleration.
<b>Jump Frequency (d3-01 through d3-04)</b>	Skips over the resonant frequencies of connected machinery.
<b>Analog Filter Time Constant (H3-13)</b>	Prevents fluctuation in the analog input signal due to noise.
<b>Stall Prevention (L3-01 through L3-06)</b>	<ul style="list-style-type: none"><li>• Prevents motor speed loss and overvoltage. Used when the load is too heavy and also during sudden acceleration/deceleration.</li><li>• Adjustment is not normally required because Stall Prevention is enabled as a default. Disable Stall Prevention during deceleration (L3-04 = "0") when using a braking resistor.</li></ul>

## 5.3 Drive Alarms, Faults, and Errors

### ◆ Types of Alarms, Faults, and Errors

Check the LED operator for information about possible faults if the drive or motor fails to operate. [Refer to Using the Digital LED Operator on page 73.](#)

If problems occur that are not covered in this manual, contact the nearest Yaskawa representative with the following information:

- Drive model
- Software version
- Date of purchase
- Description of the problem

[Table 5.3](#) contains descriptions of the various types of alarms, faults, and errors that may occur while operating the drive.

Contact Yaskawa in the event of drive failure.

**Table 5.3 Types of Alarms, Faults, and Errors**

Type	Drive Responses to Alarms, Faults, and Errors
<b>Faults</b>	<p>When the drive detects a fault:</p> <ul style="list-style-type: none"> <li>• The digital operator displays text that indicates the specific fault and the ALM indicator LED remains lit until the fault is reset.</li> <li>• The fault interrupts drive output and the motor coasts to a stop.</li> <li>• Depending on the setting, the drive and motor may stop via different methods than listed.</li> <li>• If a digital output is programmed for fault output (H2-01 = E), it will close if a fault occurs.</li> </ul> <p>When the drive detects a fault, it will remain inoperable until that fault has been reset. <a href="#">Refer to Fault Reset Methods on page 150.</a></p>
<b>Minor Faults and Alarms</b>	<p>When the drive detects an alarm or a minor fault:</p> <ul style="list-style-type: none"> <li>• The digital operator displays text that indicates the specific alarm or minor fault and the ALM indicator LED flashes.</li> <li>• The motor does not stop.</li> <li>• The multi-function contact output closes if set to be tripped by a minor fault (H2-01 = 10), but not by an alarm.</li> <li>• The digital operator displays text indicating a specific alarm and ALM indicator LED flashes.</li> </ul> <p>Remove the cause of an alarm or minor fault to automatically reset.</p>
<b>Operation Errors</b>	<p>When parameter settings conflict with one another or do not match hardware settings (such as with an option unit), it results in an operation error.</p> <p>When the drive detects an operation error:</p> <ul style="list-style-type: none"> <li>• The digital operator displays text that indicates the specific error.</li> <li>• The multi-function contact output does not operate.</li> </ul> <p>When the drive detects an operation error, it will not operate the motor until the error has been reset. Correct the settings that caused the operation error to reset.</p>

### ◆ Alarm and Error Displays

#### ■ Faults

When the drive detects a fault, the ALM indicator LEDs remain lit without flashing. If the LEDs flash, the drive has detected a minor fault or alarm. *Refer to Minor Faults and Alarms on page 129* for more information. Conditions such as overvoltage or external faults can trip both faults and minor faults, therefore it is important to note whether the LEDs remain lit or if the LEDs flash.

Table 5.4 Fault Displays

Digital Operator Display		Name	Pg.	Digital Operator Display		Name	Pg.
$\text{CE}$	CE	MEMOBUS/Modbus Communication Error	130	$\text{EF0}$	EF0	Option External Fault	132
$\text{CoF}$	CoF	Current Offset Fault	130	$\text{EF1 to EF5}$	EF1 to EF5	External Fault (input terminal S1 to S5)	132
$\text{CPF00}$ or $\text{CPF01}$ <1>	CPF00 or CPF01	CPF11 – RAM Fault	130	$\text{Err}$	Err	EEPROM Write Error	133
		CPF12 – FLASH Memory Fault	130	$\text{LF}$	LF	Output Phase Loss	133
		CPF14 – Control Circuit Fault	130	$\text{oC}$	oC	Overcurrent	133
		CPF17 – Timing Fault	130	$\text{oFA01}$	oFA01	Option Unit Fault	135
		CPF18 – Control Circuit Fault	130	$\text{oH1}$	oH1	Heatsink Overheat	135
$\text{CPF02}$	CPF02	A/D Conversion Error	131	$\text{oL1}$	oL1	Motor Overload	135
$\text{CPF06}$	CPF06	Drive Specification Mismatch during Terminal Board or Control Board Replacement	131	$\text{oL2}$	oL2	Drive Overload	136
$\text{CPF08}$	CPF08	EEPROM Serial Communications Fault	131	$\text{oL3}$	oL3	Overtorque Detection 1	137
$\text{CPF20}$ or $\text{CPF21}$ <2>	CPF20 or CPF21	RAM Fault	131	$\text{oPr}$	oPr	Operator Connection Fault	137
		FLASH Memory Fault	131	$\text{ov}$	ov	Overvoltage	137
		Watchdog Circuit Exception	131	$\text{PF}$	PF	Input Phase Loss	138
		Clock Fault	131	$\text{rH}$	rH	Dynamic Braking Resistor	139
$\text{CPF22}$	CPF22	A/D Conversion Error	131	$\text{Uv1}$	Uv1	Undervoltage	139
$\text{CPF23}$	CPF23	PWM Feedback Data Fault	132	$\text{Uv3}$	Uv3	Soft Charge Circuit Fault	140
$\text{CPF24}$	CPF24	Drive Capacity Signal Fault	132				

<1> Displayed as  $\text{CPF00}$  when occurring at drive power up. When one of the faults occurs after successfully starting the drive, the display will show  $\text{CPF01}$ .



- <2> Displayed as  $\overline{CPF20}$  when occurring at drive power up. When one of the faults occurs after successfully starting the drive, the display will show  $\overline{CPF21}$ .
- <3> Uv1 fault is not saved to the fault history

### ■ Minor Faults and Alarms

When a minor fault or alarm occurs, the ALM LED flashes and the text display shows an alarm code. A fault has occurred if the text remains lit and does not flash. [Refer to Alarm Detection on page 141](#). An overvoltage situation, for example, can trigger both faults and minor faults. It is therefore important to note whether the LEDs remain lit or if the LEDs flash.

**Table 5.5 Minor Fault and Alarm Displays**

Digital Operator Display		Name	Minor Fault Output (H2-□□ = 10)	Pg.
$\overline{bb}$	bb	Drive Baseblock	No output	<a href="#">141</a>
$\overline{CALL}$	CALL	Serial Communication Transmission Error	YES	<a href="#">141</a>
$\overline{CE}$	CE	MEMOBUS/Modbus Communication Error	YES	<a href="#">141</a>
$\overline{CrST}$	CrST	Can Not Reset	YES	<a href="#">142</a>
$\overline{EF}$	EF	Run Command Input Error	YES	<a href="#">142</a>
$\overline{EF1}$ to $\overline{EF5}$	EF1 to EF5	External Fault (input terminal S1 to S5)	YES	<a href="#">143</a>
$\overline{oH}$	oH	Heatsink Overheat	YES	<a href="#">143</a>
$\overline{oL3}$	oL3	Overtorque 1	YES	<a href="#">144</a>
$\overline{ov}$	ov	Overvoltage	YES	<a href="#">144</a>
$\overline{PASS}$	PASS	MEMOBUS/Modbus Test Mode Complete	No output	<a href="#">145</a>
$\overline{SE}$	SE	MEMOBUS/Modbus Test Mode Fault	YES	<a href="#">145</a>
$\overline{Uv}$	Uv	Undervoltage	YES	<a href="#">145</a>

### ■ Operation Errors

**Table 5.6 Operation Error Displays**

Digital Operator Display	Name	Pg.	Digital Operator Display	Name	Pg.		
$\overline{oPE01}$	oPE01	Drive Unit Setting Error	<a href="#">147</a>	$\overline{oPE05}$	oPE05	Run Command Selection Error	<a href="#">148</a>
$\overline{oPE02}$	oPE02	Parameter Setting Range Error	<a href="#">147</a>	$\overline{oPE10}$	oPE10	V/f Data Setting Error	<a href="#">148</a>
$\overline{oPE03}$	oPE03	Multi-Function Input Setting Error	<a href="#">147</a>	$\overline{oPE11}$	oPE11	Carrier Frequency Setting Error	<a href="#">148</a>

## 5.4 Fault Detection

### ◆ Fault Displays, Causes, and Possible Solutions

Table 5.7 Detailed Fault Displays, Causes, and Possible Solutions

Digital Operator Display		Fault Name
CE	CE	MEMOBUS/Modbus Communication Error
		No data was received for longer than 2 seconds.
<b>Cause</b>		<b>Possible Solution</b>
Faulty communications wiring, or a short circuit exists.		<ul style="list-style-type: none"> <li>• Check for faulty wiring.</li> <li>• Correct the wiring.</li> <li>• Check for loose wiring and short circuits. Repair as needed.</li> </ul>
A communications data error occurred due to noise.		<ul style="list-style-type: none"> <li>• Check the various options available to minimize the effects of noise.</li> <li>• Counteract noise in control circuit, main circuit, and ground wiring.</li> <li>• Use Yaskawa-recommended cables, or another type of shielded line. Ground the shield on the controller side or on the drive input power side.</li> <li>• Ensure that other equipment such as switches or relays do not cause noise and use surge suppressors if required.</li> <li>• Separate all wiring for communications devices from drive input power lines. Install an EMC noise filter to the input side of the drive input power.</li> </ul>

Digital Operator Display		Fault Name
CoF	CoF	Current Offset Fault
		The current sensor is damaged or there was residual induction current in the motor (e.g., during sudden deceleration or when coasting) when the drive attempted to start the motor.
<b>Cause</b>		<b>Possible Solution</b>
Due to residual induction current in the motor when the drive attempted to start the motor, the drive attempted to adjust the current offset value beyond the allowable range.		Create a motor restart sequence that allows enough time for the residual induction voltage to dissipate.

Digital Operator Display		Fault Name
CPF00 or CPF01	CPF00 or CPF01	CPF11 – RAM Fault
		CPF12 – Problem with the ROM (FLASH memory)
<b>Cause</b>		<b>Possible Solution</b>
Hardware is damaged.		Replace the drive.

Digital Operator Display		Fault Name
CPF02	CPF02	A/D Conversion Error An A/D conversion error occurred.
<b>Cause</b>		<b>Possible Solution</b>
Control circuit is damaged.		Cycle power to the drive. If the problem continues, replace the drive.
Control circuit terminals have shorted out (+V, AC).		<ul style="list-style-type: none"> <li>• Check for wiring errors along the control circuit terminals.</li> <li>• Correct the wiring.</li> </ul>
		Check the resistance of the speed potentiometer and related wiring.
Control terminal input current has exceeded allowable levels.		<ul style="list-style-type: none"> <li>• Check the input current.</li> <li>• Reduce the current input to control circuit terminal (+V) to 20 mA.</li> </ul>

Digital Operator Display		Fault Name
CPF06	CPF06	EEPROM Data Error There is an error in the data saved to EEPROM.
<b>Cause</b>		<b>Possible Solution</b>
Control circuit is damaged.		Cycle power to the drive. If the problem continues, replace the drive.
The power supply was switched off when parameters were written (e.g., using a communications option card).		<ul style="list-style-type: none"> <li>• Cycle power to the drive and check operation again.</li> <li>• Initialize the drive using A1-03.</li> <li>• If the problem persists after initializing the drive, replace the drive.</li> </ul>

Digital Operator Display		Fault Name
CPF08	CPF08	EEPROM Serial Communication Fault EEPROM communications are not functioning properly.
<b>Cause</b>		<b>Possible Solution</b>
Control circuit is damaged.		Cycle power to the drive. If the problem persists, replace the drive.

Digital Operator Display		Fault Name
CPF20 or CPF21	CPF20 or CPF21	One of the following faults occurred: RAM fault, FLASH memory error, watchdog circuit exception, clock error <ul style="list-style-type: none"> <li>• RAM fault.</li> <li>• FLASH memory error (ROM error).</li> <li>• Watchdog circuit exception (self-diagnostic error).</li> <li>• Clock error.</li> </ul>
<b>Cause</b>		<b>Possible Solution</b>
Hardware is damaged.		Replace the drive.

Digital Operator Display		Fault Name
CPF22	CPF22	A/D Conversion Fault A/D conversion error.

## 5.4 Fault Detection

Digital Operator Display	Fault Name
Cause	Possible Solution
Control circuit is damaged.	<ul style="list-style-type: none"> <li>• Cycle power to the drive. <i>Refer to Diagnosing and Resetting Faults on page 149.</i></li> <li>• If the problem continues, replace the drive.</li> </ul>

Digital Operator Display	Fault Name
Cause	Possible Solution
$CPF23$ CPF23	PWM Feedback Fault
	PWM feedback error.
Hardware is damaged.	Replace the drive.

Digital Operator Display	Fault Name
Cause	Possible Solution
$CPF24$ CPF24	Drive Capacity Signal Fault
	Entered a capacity that does not exist. (Checked when the drive is powered up.)
Hardware is damaged.	Replace the drive.

Digital Operator Display	Fault Name
Cause	Possible Solution
$EF0$ EF0	MEMOBUS/Modbus Communication External Fault
	An external fault condition is present.
An external fault was received from the PLC with other than H5-04 = 3 "alarm only" (the drive continued to run after external fault).	<ul style="list-style-type: none"> <li>• Remove the cause of the external fault.</li> <li>• Remove the external fault input from the PLC.</li> </ul>
Problem with the PLC program.	Check the PLC program and correct problems.

Digital Operator Display	Fault Name
$EF1$ EF1	External Fault (input terminal S1)
	External fault at multi-function input terminal S1.
$EF2$ EF2	External Fault (input terminal S2)
	External fault at multi-function input terminal S2.
$EF3$ EF3	External Fault (input terminal S3)
	External fault at multi-function input terminal S3.
$EF4$ EF4	External Fault (input terminal S4)
	External fault at multi-function input terminal S4.
$EF5$ EF5	External Fault (input terminal S5)
	External fault at multi-function input terminal S5.

Digital Operator Display	Fault Name
Cause	Possible Solution
An external device has tripped an alarm function.	Remove the cause of the external fault and reset the fault.
Wiring is incorrect.	<ul style="list-style-type: none"> <li>Ensure the signal lines have been connected properly to the terminals assigned for external fault detection (H1-□□ = 20 to 2F).</li> <li>Reconnect the signal line.</li> </ul>
Incorrect setting of multi-function contact inputs.	<ul style="list-style-type: none"> <li>Check if the unused terminals set for H1-□□ = 20 to 2F (External Fault).</li> <li>Change the terminal settings.</li> </ul>

Digital Operator Display	Fault Name
$E_{rr}$	Err
	EEPROM Write Error
	Data does not match the EEPROM being written to.
Cause	Possible Solution
-	<ul style="list-style-type: none"> <li>Press the ENTER button.</li> <li>Correct the parameter settings.</li> <li>Cycle power to the drive. <i>Refer to Diagnosing and Resetting Faults on page 149.</i></li> </ul>

Digital Operator Display	Fault Name
$LF$	LF
	Output Phase Loss
	Phase loss on the output side of the drive.
Cause	Possible Solution
The output cable is disconnected.	<ul style="list-style-type: none"> <li>Check for wiring errors and ensure the output cable is connected properly.</li> <li>Correct the wiring.</li> </ul>
The motor winding is damaged.	<ul style="list-style-type: none"> <li>Check the resistance between motor lines.</li> <li>Replace the motor if the winding is damaged.</li> </ul>
The output terminal is loose.	<ul style="list-style-type: none"> <li>Apply the tightening torque specified in this manual to fasten the terminals. <i>Refer to Wire Size and Torque Specifications on page 55.</i></li> </ul>
The motor being used is less than 5% of the drive rated current.	Check the drive and motor capacities.
An output transistor is damaged.	Replace the drive.
A single-phase motor is being used.	The drive being used cannot operate a single phase motor.

Digital Operator Display	Fault Name
$oC$	oC
	Overcurrent
	Drive sensors have detected an output current greater than the specified overcurrent level.
Cause	Possible Solution

## 5.4 Fault Detection

Digital Operator Display	Fault Name
The motor has been damaged due to overheating or the motor insulation is damaged.	<ul style="list-style-type: none"> <li>• Check the insulation resistance.</li> <li>• Replace the motor.</li> </ul>
One of the motor cables has shorted out or there is a grounding problem.	<ul style="list-style-type: none"> <li>• Check the motor cables.</li> <li>• Remove the short circuit and power the drive back up.</li> <li>• Check the resistance between the motor cables and the ground terminal ⊕.</li> <li>• Replace damaged cables.</li> </ul>
The load is too heavy.	<ul style="list-style-type: none"> <li>• Measure the current flowing into the motor.</li> <li>• Replace the drive with a larger capacity unit if the current value exceeds the rated current of the drive.</li> <li>• Determine if there is sudden fluctuation in the current level.</li> <li>• Reduce the load to avoid sudden changes in the current level or switch to a larger drive.</li> </ul>
The acceleration or deceleration times are too short.	<p>Calculate the torque needed during acceleration relative to the load inertia and the specified acceleration time. If the right amount of torque cannot be set, make the following changes:</p> <ul style="list-style-type: none"> <li>• Increase the acceleration time (C1-01, C1-03)</li> <li>• Increase the S-curve characteristics (C2-01 through C2-04)</li> <li>• Increase the capacity of the drive.</li> </ul>
The drive is attempting to operate a specialized motor or a motor larger than the maximum size allowed.	<ul style="list-style-type: none"> <li>• Check the motor capacity.</li> <li>• Ensure that the rated capacity of the drive is greater than or equal to the capacity rating found on the motor nameplate.</li> </ul>
Magnetic contactor (MC) on the output side of the drive has turned on or off.	Set up the operation sequence so that the MC is not tripped while the drive is outputting current.
V/f setting is not operating as expected.	<ul style="list-style-type: none"> <li>• Check the ratios between the voltage and frequency.</li> <li>• Set parameters E1-04 through E1-10 appropriately.</li> <li>• Lower the voltage if it is too high relative to the frequency.</li> </ul>
Excessive torque compensation.	<ul style="list-style-type: none"> <li>• Check the amount of torque compensation.</li> <li>• Reduce the torque compensation gain (C4-01) until there is no speed loss and less current.</li> </ul>
Drive fails to operate properly due to noise interference.	<ul style="list-style-type: none"> <li>• Review the possible solutions provided for handling noise interference.</li> <li>• Review the section on handling noise interference and check the control circuit lines, main circuit lines, and ground wiring.</li> </ul>
Overexcitation gain is set too high.	<ul style="list-style-type: none"> <li>• Check if fault occurs simultaneously to overexcitation function operation.</li> <li>• Consider motor flux saturation and reduce the value of n3-13 (Overexcitation Deceleration Gain).</li> </ul>
Run command applied while motor was coasting.	Program the Speed Search command input through one of the multi-function contact input terminals (H1-□□ = 61 or 62).
The motor cable is too long	Use a larger drive.

Digital Operator Display		Fault Name
oFA01	oFA01	Option Unit Fault
		Replace the option unit.
<b>Cause</b>		<b>Possible Solution</b>
The option unit is not connected properly to the drive.		Turn the power off and reconnect the option unit.

Digital Operator Display		Fault Name
oH1	oH1	Overheat 1 (Heatsink Overheat)
		The temperature of the heatsink has exceeded the overheat pre-alarm level.
<b>Cause</b>		<b>Possible Solution</b>
Surrounding temperature is too high.		<ul style="list-style-type: none"> <li>• Check the temperature surrounding the drive.</li> <li>• Improve the air circulation within the enclosure panel.</li> <li>• Install a fan or air conditioner to cool the surrounding area.</li> <li>• Remove anything near the drive that might be producing excessive heat.</li> </ul>
Load is too heavy.		<ul style="list-style-type: none"> <li>• Measure the output current.</li> <li>• Lower the carrier frequency (C6-02).</li> <li>• Reduce the load.</li> </ul>
Current flowing to control circuit terminal +V exceeded the tolerance level.		<ul style="list-style-type: none"> <li>• Check the current level of the terminal.</li> <li>• Set the current to the control circuit terminal to be 20 mA or less.</li> </ul>

Digital Operator Display		Fault Name
oL1	oL1	Motor Overload
		The electrothermal sensor tripped overload protection. <b>Note:</b> The integrated value of the internal register for oL1 must decrease before oL1 can be reset.
<b>Cause</b>		<b>Possible Solution</b>
Load is too heavy.		Reduce the load.
Cycle times are too short during acceleration and deceleration.		Increase the acceleration and deceleration times (C1-01 through C1-04).
<ul style="list-style-type: none"> <li>• Drive overloaded at low speeds.</li> <li>• Overload may occur at low speeds when using a general-purpose motor, even if operating within the rated current limitation.</li> </ul>		<ul style="list-style-type: none"> <li>• Reduce the load.</li> <li>• Increase the speed.</li> <li>• If the drive is supposed to operate at low speeds, either increase the motor capacity or use a motor specifically designed to operate with the drive.</li> </ul>
Although a special type of motor is being used, the motor protection selection is set for a general-purpose motor (L1-01 = 1).		Set L1-01 to 2.

## 5.4 Fault Detection

Digital Operator Display	Fault Name
Voltage is too high for the V/f characteristics.	<ul style="list-style-type: none"> <li>Adjust the user set V/f patterns (E1-04 through E1-10). Parameters E1-08 and E1-10 may need to be reduced.</li> <li>If E1-08 and E1-10 are set too high, there may be very little load tolerance at low speed.</li> </ul>
The wrong motor-rated current is set to E2-01.	<ul style="list-style-type: none"> <li>Check the motor-rated current.</li> <li>Enter the value written on the motor nameplate to parameter E2-01.</li> </ul>
The motor base frequency for the drive input power is set too low.	<ul style="list-style-type: none"> <li>Check the rated frequency indicated on the motor nameplate.</li> <li>Enter the rated frequency to E1-06 (Base Frequency).</li> </ul>
Multiple motors are running off the same drive.	Set L1-01 to 0 to disable the Motor Protection function and install a thermal relay to each motor.
The electrical thermal protection characteristics and motor overload characteristics do not match.	<ul style="list-style-type: none"> <li>Check the motor characteristics.</li> <li>Correct the value set to L1-01 (Motor Protection Function).</li> <li>Install an external thermal relay.</li> </ul>
The electrical thermal relay is operating at the wrong level.	<ul style="list-style-type: none"> <li>Check the current rating listed on the motor nameplate.</li> <li>Check the value set for the motor-rated current (E2-01).</li> </ul>
Motor overheated by overexcitation operation.	<ul style="list-style-type: none"> <li>Overexcitation increases the motor losses and the motor temperature. If applied too long, motor damage can occur. Prevent excessive overexcitation operation or apply proper cooling to the motor</li> <li>Reduce the excitation deceleration gain (n3-13).</li> <li>Set L3-04 (Stall Prevention during Deceleration) to a value other than 4.</li> </ul>
Output current fluctuation due to input phase loss	Check the power supply for phase loss.

Digital Operator Display	Fault Name
$\sigma \overset{\sim}{L} \overset{\sim}{L}^2$	Drive Overload
$\sigma L2$	The thermal sensor of the drive triggered overload protection.
<b>Cause</b>	<b>Possible Solution</b>
Load is too heavy.	Reduce the load.
Cycle times are too short during acceleration and deceleration.	Increase the settings for the acceleration and deceleration times (C1-01 through C1-04).
Voltage is too high for the V/f characteristics.	<ul style="list-style-type: none"> <li>Adjust the preset V/f pattern (E1-04 through E1-10). This will mainly involve reducing E1-08 and E1-10.</li> <li>Be careful not to lower E1-08 and E1-10 excessively because this reduces load tolerance at low speeds.</li> </ul>
Drive capacity is too small.	Replace the drive with a larger model.
Overload occurred when operating at low speeds.	<ul style="list-style-type: none"> <li>Reduce the load when operating at low speeds.</li> <li>Replace the drive with a model that is one frame size larger.</li> <li>Lower the carrier frequency (C6-02).</li> </ul>
Excessive torque compensation.	Reduce the torque compensation gain (C4-01) until there is no speed loss but less current.



Digital Operator Display	Fault Name
Output current fluctuation due to input phase loss	Check the power supply for phase loss.

Digital Operator Display	Fault Name
OL3	Overtorque Detection 1
	The current has exceeded the value set for torque detection (L6-02) for longer than the allowable time (L6-03).
<b>Cause</b>	<b>Possible Solution</b>
Parameter settings are not appropriate for the type of load.	Check the settings of parameters L6-02 and L6-03.
There is a fault on the machine side (e.g., the machine is locked up).	Check the status of the load. Remove the cause of the fault.

Digital Operator Display	Fault Name
oPr	External Digital Operator Connection Fault
	<ul style="list-style-type: none"> <li>The external operator has been disconnected from the drive.</li> </ul> <b>Note:</b> An oPr fault will occur when all of the following conditions are true: <ul style="list-style-type: none"> <li>Output is interrupted when the operator is disconnected (o2-06 = 1).</li> <li>The run command is assigned to the operator (b1-02 = 0 and LOCAL has been selected).</li> </ul>
<b>Cause</b>	<b>Possible Solution</b>
External operator is not properly connected to the drive.	<ul style="list-style-type: none"> <li>Check the connection between the operator and the drive.</li> <li>Replace the cable if damaged.</li> <li>Turn off the drive input power and disconnect the operator. Next reconnect the operator and turn the drive input power back on.</li> </ul>

Digital Operator Display	Fault Name
OV	Overvoltage
	Voltage in the DC bus has exceeded the overvoltage detection level.
	<ul style="list-style-type: none"> <li>For 200 V class: approximately 410 V</li> <li>For 400 V class: approximately 820 V (740 V when E1-01 is less than 400)</li> </ul>
<b>Cause</b>	<b>Possible Solution</b>
Deceleration time is too short and regenerative energy flows from the motor into the drive.	<ul style="list-style-type: none"> <li>Increase the deceleration time (C1-02, C1-04).</li> <li>Install a braking resistor or a dynamic braking resistor unit.</li> <li>Set L3-04 to 1 to enable stall prevention during deceleration. Stall prevention is enabled as the default setting.</li> </ul>
Excessive braking load.	The braking torque was too high, causing regenerative energy to charge the DC bus. Reduce the braking torque, use a braking option, or lengthen decel time.
Surge voltage entering from the drive input power.	Install a DC link choke. <b>Note:</b> Voltage surge can result from thyristor convertor and phase advancing capacitor using same drive main input power supply.

## 5.4 Fault Detection

Digital Operator Display	Fault Name
Ground fault in the output circuit causing the DC bus capacitor to overcharge.	<ul style="list-style-type: none"> <li>Check the motor wiring for ground faults.</li> <li>Correct grounding shorts and turn the power back on.</li> </ul>
Excessive regeneration when overshoot occurs after acceleration.	Lengthen the S-curve at acceleration end.
Drive input power voltage is too high.	<ul style="list-style-type: none"> <li>Check the voltage.</li> <li>Lower drive input power voltage within the limits listed in the specifications.</li> </ul>
The dynamic braking transistor is damaged.	Replace the drive.
The braking transistor is wired incorrectly.	<ul style="list-style-type: none"> <li>Check braking transistor wiring for errors.</li> <li>Properly rewire the braking resistor device.</li> </ul>
Drive fails to operate properly due to noise interference.	<ul style="list-style-type: none"> <li>Review the list of possible solutions provided for controlling noise.</li> <li>Review the section on handling noise interference and check the control circuit lines, main circuit lines and ground wiring.</li> </ul>
Motor hunting occurs.	<ul style="list-style-type: none"> <li>Adjust the parameters that control hunting.</li> <li>Set the hunting prevention gain (n1-02).</li> </ul>

Digital Operator Display		Fault Name
$PF$	PF	Input Phase Loss
		Drive input power has an open phase or has a large imbalance of voltage between phases. Detected when L8-05 = 1 (enabled).
<b>Cause</b>		<b>Possible Solution</b>
There is phase loss in the drive input power.		<ul style="list-style-type: none"> <li>Check for wiring errors in the main circuit drive input power.</li> <li>Correct the wiring.</li> </ul>
There is loose wiring in the drive input power terminals.		<ul style="list-style-type: none"> <li>Ensure the terminals are tightened properly.</li> <li>Apply the tightening torque specified in this manual to fasten the terminals. <i>Refer to Wire Gauges and Tightening Torques on page 46</i> for details.</li> </ul>
There is excessive fluctuation in the drive input power voltage.		<ul style="list-style-type: none"> <li>Check the voltage from the drive input power.</li> <li>Review the possible solutions for stabilizing the drive input power.</li> <li>Disable Input Phase Loss Detection (L8-05 = "0"). PF is detected if DC bus ripple is too high. If it is disabled, there is no fault but the ripple is still too high, thereby the capacitors are stressed more and lose lifetime.</li> </ul>
There is poor balance between voltage phases.		<ul style="list-style-type: none"> <li>Stabilize drive input power or disable phase loss detection.</li> </ul>


Digital Operator Display	Fault Name
The main circuit capacitors are worn.	<ul style="list-style-type: none"> <li>Check the maintenance time for the capacitors (U4-05).</li> <li>Replace the drive if U4-05 is greater than 90%.</li> </ul>
	<ul style="list-style-type: none"> <li>Check for anything wrong with the drive input power.</li> <li>If nothing is wrong with the drive input power, try the following solutions if the alarm continues:                             <ul style="list-style-type: none"> <li>Set L8-05 to 0 to disable Input Phase Loss Protection selection. PF is detected when DC bus ripple is too high. If it is disabled, there is no fault but the ripple is still too high, the capacitors are stressed more and lose lifetime.</li> </ul> </li> <li>Replace the drive.</li> </ul>

Digital Operator Display		Fault Name
$rH$	rH	Braking Resistor Overheat
		Braking resistor protection was triggered. Fault detection is enabled when L8-01 = 1 (disabled as a default).
Cause		Possible Solution
Deceleration time is too short and excessive regenerative energy is flowing back into the drive.		<ul style="list-style-type: none"> <li>Check the load, deceleration time and speed.</li> <li>Reduce the load.</li> <li>Increase the acceleration and deceleration times (C1-01 through C1-04).</li> <li>Replace the braking option with a larger device that can handle the power that is discharged.</li> </ul>
Excessive braking inertia.		Recalculate braking load and braking power. Then try reducing the braking load and checking the braking resistor settings and improve braking capacity.
The proper braking resistor has not been installed.		<ul style="list-style-type: none"> <li>Check the specifications and conditions for the braking resistor device.</li> <li>Select the optimal braking resistor.</li> </ul>
<p><b>Note:</b> The magnitude of the braking load trips the braking resistor overheat alarm, NOT the surface temperature. Using the braking resistor more frequently than its rating trips the alarm even when the braking resistor surface is not very hot.</p>		

Digital Operator Display		Fault Name
$Uv1$	Uv1	DC Bus Undervoltage
		One of the following conditions occurred while the drive was in operation: <ul style="list-style-type: none"> <li>Voltage in the DC bus fell below the undervoltage detection level.</li> <li>For 200 V class: approximately 190 V (160 V for single phase drives)</li> <li>For 400 V class: approximately 380 V (350 V when E1-01 is less than 400) The fault is output only if L2-01 = 0 or L2-01 = 1 and the DC bus voltage is under L2-05 for longer than L2-02.</li> </ul>
Cause		Possible Solution
Input power phase loss.		<ul style="list-style-type: none"> <li>The main circuit drive input power is wired incorrectly.</li> <li>Correct the wiring.</li> </ul>
One of the drive input power wiring terminals is loose.		<ul style="list-style-type: none"> <li>Ensure there are no loose terminals.</li> <li>Apply the tightening torque specified in this manual to fasten the terminals. <i>Refer to Wire Gauges and Tightening Torques on page 46</i> for details.</li> </ul>

## 5.4 Fault Detection

Digital Operator Display	Fault Name
There is a problem with the voltage from the drive input power.	<ul style="list-style-type: none"> <li>• Check the voltage.</li> <li>• Correct the voltage to within range listed in drive input power specifications.</li> </ul>
The power has been interrupted.	Correct the drive input power.
Drive internal circuitry has become worn.	<ul style="list-style-type: none"> <li>• Check the maintenance time for the capacitors (U4-05).</li> <li>• Replace the drive if U4-05 exceeds 90%.</li> </ul>
The drive input power transformer is not large enough and voltage drops after switching on power.	Check the capacity of the drive input power transformer.
Air inside the drive is too hot.	Check the drive internal temperature.
Problem with the CHARGE indicator.	Replace the drive.

Digital Operator Display		Fault Name
	Uv3	Undervoltage 3 (Inrush Prevention Circuit Fault)
		The inrush prevention circuit has failed.
<b>Cause</b>		<b>Possible Solution</b>
The contactor on the inrush prevention circuit is damaged.		<ul style="list-style-type: none"> <li>• Cycle power to the drive. Check if the fault reoccurs.</li> <li>• Replace the drive if the fault continues to occur.</li> <li>• Check monitor U4-06 for the performance life of the inrush prevention circuit.</li> <li>• Replace the drive if U4-06 exceeds 90%.</li> </ul>

## 5.5 Alarm Detection

Alarms are drive protection functions that do not operate the fault contact. The drive will return to original status when the cause of the alarm has been removed.

During an alarm condition, the Digital Operator display flashes and an alarm output is generated at the multi-function output (H2-01), if programmed.

Investigate the cause of the alarm and refer to [Table 5.8](#) for the appropriate action.

### ◆ Alarm Codes, Causes, and Possible Solutions

Table 5.8 Detailed Alarm Codes, Causes, and Possible Solutions

Digital Operator Display		Minor Fault Name	
bb	bb	Baseblock	
		Drive output interrupted as indicated by an external baseblock signal.	
Cause		Possible Solution	Minor Fault (H2-□□ = 10)
External baseblock signal entered via multi-function input terminal (S1 to S5).		Check external sequence and baseblock signal input timing.	No output
Digital Operator Display		Minor Fault Name	
CALL	CALL	Serial Communication Transmission Error	
		Communication has not yet been established.	
Cause		Possible Solution	Minor Fault (H2-□□ = 10)
Communications wiring is faulty, there is a short circuit, or something is not connected properly.		<ul style="list-style-type: none"> <li>• Check for wiring errors.</li> <li>• Correct the wiring.</li> <li>• Remove and ground shorts and reconnect loose wires.</li> </ul>	YES
Programming error on the master side.		Check communications at start-up and correct programming errors.	
Communications circuitry is damaged.		<ul style="list-style-type: none"> <li>• Perform a self-diagnostics check.</li> <li>• Replace the drive if the fault continues to occurs.</li> </ul>	
Terminal resistance setting is incorrect.		The terminal slave drive must have the internal terminal resistance switch set correctly. Place DIP switch S2 to the ON position.	
Digital Operator Display		Minor Fault Name	
CE	CE	MEMOBUS/Modbus Communication Error	
		Control data was not received correctly for two seconds.	

## 5.5 Alarm Detection

Digital Operator Display		Minor Fault Name	
Cause	Possible Solution	Minor Fault (H2-□□ = 10)	
A data error occurred due to noise.	<ul style="list-style-type: none"> <li>Check options available to minimize the effects of noise.</li> <li>Counteract noise in the control circuit wiring, main circuit lines and ground wiring.</li> <li>Reduce noise on the controller side.</li> <li>Use surge absorbers on magnetic contactors or other equipment causing the disturbance.</li> <li>Use cables recommended by Yaskawa or another type of shielded line. The shield should be grounded on the controller side or on the drive input power side.</li> <li>Separate all wiring for communications devices from drive input power lines. Install an EMC noise filter to the input side of the drive input power.</li> </ul>	YES	
Communication protocol is incompatible.	<ul style="list-style-type: none"> <li>Check the H5 parameter settings as well as the protocol setting in the controller.</li> <li>Ensure settings are compatible.</li> </ul>		
The CE detection time (H5-09) is set shorter than the time required for a communication cycle to take place.	<ul style="list-style-type: none"> <li>Check the PLC.</li> <li>Change the software settings in the PLC.</li> <li>Set a longer CE detection time (H5-09).</li> </ul>		
Incompatible PLC software settings or there is a hardware problem.	<ul style="list-style-type: none"> <li>Check the PLC.</li> <li>Remove the cause of the error on the controller side.</li> </ul>		
Communications cable is disconnected or damaged.	<ul style="list-style-type: none"> <li>Check the connector for a signal through the cable.</li> <li>Replace the communications cable.</li> </ul>		

Digital Operator Display		Minor Fault Name	
$\overline{CrST}$	CrST	Can Not Reset	
Cause	Possible Solution	Minor Fault (H2-□□ = 10)	
Fault reset was being executed when a Run command was entered.	<ul style="list-style-type: none"> <li>Ensure that a run command cannot be entered from the external terminals or option card during fault reset.</li> <li>Turn off the Run command.</li> </ul>	YES	

Digital Operator Display		Minor Fault Name	
$\overline{EF}$	EF	Forward/Reverse Run Command Input Error	
		Both forward run and reverse run closed simultaneously for longer than 0.5 s.	
Cause	Possible Solution	Minor Fault (H2-□□ = 10)	

Digital Operator Display	Minor Fault Name	
Sequence error	Check the forward and reverse command sequence and correct the problem. <b>Note:</b> Motor ramps to stop when minor fault EF is detected.	YES

Digital Operator Display		Minor Fault Name	
<i>EF1</i>	EF1	External fault (input terminal S1)	
		External fault at multi-function input terminal S1.	
<i>EF2</i>	EF2	External fault (input terminal S2)	
		External fault at multi-function input terminal S2.	
<i>EF3</i>	EF3	External fault (input terminal S3)	
		External fault at multi-function input terminal S3.	
<i>EF4</i>	EF4	External fault (input terminal S4)	
		External fault at multi-function input terminal S4.	
<i>EF5</i>	EF5	External fault (input terminal S5)	
		External fault at multi-function input terminal S5.	
Cause		Possible Solution	Minor Fault (H12-□□ = 10)
An external device has tripped an alarm function.		Remove the cause of the external fault and reset the multi-function input value.	YES
Wiring is incorrect.		<ul style="list-style-type: none"> <li>• Ensure the signal lines have been connected properly to the terminals assigned for external fault detection (H1-□□ = 20 to 2F).</li> <li>• Reconnect the signal line.</li> </ul>	
Multi-function contact inputs are set incorrectly.		<ul style="list-style-type: none"> <li>• Check if the unused terminals have been set for H1-□□ = 20 to 2F (External Fault).</li> <li>• Change the terminal settings.</li> </ul>	

Digital Operator Display		Minor Fault Name	
<i>oH</i>	oH	Heatsink Overheat	
		The temperature exceeded the value set to L8-02.	
Cause		Possible Solution	Minor Fault (H12-□□ = 10)

## 5.5 Alarm Detection

Digital Operator Display		Minor Fault Name	
Surrounding temperature is too high		<ul style="list-style-type: none"> <li>Check the surrounding temperature.</li> <li>Improve the air circulation within the enclosure panel.</li> <li>Install a fan or air conditioner to cool surrounding area.</li> <li>Remove anything near drive that may cause extra heat.</li> </ul>	YES
Internal cooling fan has stopped.		<ul style="list-style-type: none"> <li>Replace the cooling fan.</li> <li>After replacing the fan, reset the cooling fan maintenance parameter to (o4-03 = "0").</li> </ul>	
Airflow around the drive is restricted.		<ul style="list-style-type: none"> <li>Provide proper installation space around the drive as indicated in the manual. <i>Refer to on page 30.</i></li> <li>Allow for the specified space and ensure that there is sufficient circulation around the control panel.</li> <li>Check for dust or foreign materials clogging cooling fan.</li> <li>Clear debris caught in the fan that restricts air circulation.</li> </ul>	

Digital Operator Display		Minor Fault Name	
	oL3	Overtorque 1	
		Drive output current was greater than L6-02 for longer than the time set in L6-03.	
<b>Cause</b>		<b>Possible Solution</b>	<b>Minor Fault (H2-□□ = 10)</b>
Inappropriate parameter settings.		Check parameters L6-02 and L6-03.	YES
There is a fault on the machine side (e.g., the machine is locked up).		<ul style="list-style-type: none"> <li>Check the status of the machine.</li> <li>Remove the cause of the fault.</li> </ul>	

Digital Operator Display		Minor Fault Name	
	ov	DC Bus Overvoltage	
		The DC bus voltage exceeded the trip point. For 200 V class: approximately 410 V For 400 V class: approximately 820 V (740 V when E1-01 < 400)	
<b>Cause</b>		<b>Possible Solution</b>	<b>Minor Fault (H2-□□ = 10)</b>



Digital Operator Display	Minor Fault Name	
Surge voltage present in the drive input power.	<ul style="list-style-type: none"> <li>Install an AC reactor or DC link choke.</li> <li>Voltage surge can result from a thyristor convertor and a phase advancing capacitor operating on the same drive input power system.</li> </ul>	YES
<ul style="list-style-type: none"> <li>The motor is short-circuited.</li> <li>Ground current has over-charged the main circuit capacitors via the drive input power.</li> </ul>	<ul style="list-style-type: none"> <li>Check the motor power cable, relay terminals and motor terminal box for short circuits.</li> <li>Correct grounding shorts and turn the power back on.</li> </ul>	
Noise interference causes the drive to operate incorrectly.	<ul style="list-style-type: none"> <li>Review possible solutions for handling noise interference.</li> <li>Review section on handling noise interference and check control circuit lines, main circuit lines and ground wiring.</li> <li>If the magnetic contactor is identified as a source of noise, install a surge protector to the MC coil.</li> </ul>	
		Set number of fault restarts (L5-01) to a value other than 0.

Digital Operator Display	Minor Fault Name	
P P S S	PASS	MEMOBUS/Modbus Comm. Test Mode Complete
Cause	Possible Solution	Minor Fault (H2-□□ = 10)
MEMOBUS/Modbus test has finished normally.	This verifies that the test was successful.	No output

Digital Operator Display	Minor Fault Name	
SE	SE	MEMOBUS/Modbus Communication Test Mode Error
Cause	Possible Solution	Minor Fault (H2-□□ = 10)

Digital Operator Display	Minor Fault Name	
Uv	Uv	Undervoltage
	One of the following conditions was true when the drive was stopped and a run command was entered: <ul style="list-style-type: none"> <li>DC bus voltage dropped below the undervoltage detection level.</li> <li>Contactor to suppress inrush current in the drive was open.</li> <li>Low voltage in the control drive input power. This alarm outputs only if L2-01 is not 0 and DC bus voltage is below the detection level.</li> </ul>	
Cause	Possible Solution	Minor Fault (H2-□□ = 10)

## 5.5 Alarm Detection

Digital Operator Display	Minor Fault Name	
Phase loss in the drive input power.	Check for wiring errors in the main circuit drive input power. Correct the wiring.	YES
Loose wiring in the drive input power terminals.	<ul style="list-style-type: none"> <li>Ensure the terminals have been properly tightened.</li> <li>Apply the tightening torque specified in this manual to fasten the terminals. <i>Refer to Wire Gauges and Tightening Torques on page 46.</i></li> </ul>	
There is a problem with the drive input power voltage.	<ul style="list-style-type: none"> <li>Check the voltage.</li> <li>Lower the voltage of the drive input power so that it is within the limits listed in the specifications.</li> </ul>	
Drive internal circuitry is worn.	<ul style="list-style-type: none"> <li>Check the maintenance time for the capacitors (U4-05).</li> <li>Replace the drive if U4-05 exceeds 90%.</li> </ul>	
The drive input power transformer is not large enough and voltage drops when the power is switched on.	<ul style="list-style-type: none"> <li>Check for a tripped alarm when the magnetic contactor, line breaker and leakage breaker are turned on.</li> <li>Check the capacity of the drive input power transformer.</li> </ul>	
Air inside the drive is too hot.	Check the temperature inside the drive.	
The CHARGE indicator light is broken or disconnected.	Replace the drive.	


## 5.6 Operator Programming Errors


An Operator Programming Error (oPE) occurs when an inappropriate parameter is set or an individual parameter setting is inappropriate.

The drive will not operate until the parameter is set correctly; however, no alarm or fault outputs will occur. If an oPE occurs, investigate the cause and *Refer to Detailed oPE Codes, Causes, and Possible Solutions on page 147* for the appropriate action.


### ◆ oPE Codes, Causes, and Possible Solutions

**Table 5.9 Detailed oPE Codes, Causes, and Possible Solutions**

Digital Operator Display		Error Name
	oPE01	Drive Capacity Setting Fault
		Drive capacity and the value set to o2-04 do not match.
Cause		Possible Solution
The drive capacity setting (o2-04) and the actual capacity of the drive are not the same.		Correct the value set to o2-04.


Digital Operator Display		Fault Name
	oPE02	Parameter Range Setting Error
Cause		Possible Solution
Parameters were set outside the possible setting range.		Set parameters to the proper values.


**Note:** Other errors are given precedence over oPE02 when multiple errors occur at the same time.


Digital Operator Display		Fault Name
	oPE03	Multi-Function Input Selection Error
		A contradictory setting is assigned to multi-function contact inputs H1-01 to H1-05.
Cause		Possible Solution
<ul style="list-style-type: none"> <li>The same function is assigned to two multi-function inputs.</li> <li>Excludes “Not used” and “External Fault.”</li> </ul>		<ul style="list-style-type: none"> <li>Ensure all multi-function inputs are assigned to different functions.</li> <li>Re-enter the multi-function settings to ensure this does not occur.</li> </ul>
<ul style="list-style-type: none"> <li>The Up command was set but the Down command was not, or vice versa (settings 10 vs. 11).</li> <li>Run command for a 2-Wire sequence was set, but forward/reverse command for a 2-Wire sequence was not.</li> </ul>		Correctly set functions that need to be enabled in combination with other functions.

## 5.6 Operator Programming Errors

Digital Operator Display	Fault Name
<p>The following two functions are set at the same time:</p> <ul style="list-style-type: none"> <li>Up/Down Command (10 vs. 11)</li> <li>Hold Accel/Decel Stop (A)</li> </ul>	<ul style="list-style-type: none"> <li>Check if contradictory settings have been assigned to the multi-function input terminals at the same time.</li> <li>Correct setting errors.</li> </ul>
<p>One of the following settings is set at the multi-function input terminals:</p> <ul style="list-style-type: none"> <li>External Search Command 1 and External Search Command 2 (61 vs. 62)</li> <li>Fast-Stop N.O. and Fast-Stop N.C. (15 vs. 17)</li> </ul>	

Digital Operator Display	Fault Name
	oPE05
Run Command/Frequency Reference Source Selection Error	
Cause	Possible Solution
<p>Frequency reference is assigned to an option unit (b1-01 = 2 or 3) that is not connected to the drive.</p>	<p>Reconnect the option card to the drive.</p>
<p>The Run command is assigned to serial communication (b1-02 = 2) but no communication option is connected to the drive.</p>	

Digital Operator Display	Fault Name
	oPE10
V/f Data Setting Error	
One or more of the parameters listed below are not set according to the formula: $E1-09 \leq E1-07 < E1-06 \leq E1-04$	
Cause	Possible Solution

Digital Operator Display	Fault Name
	oPE11
Carrier Frequency Setting Error	
Correct the setting for the carrier frequency.	
Cause	Possible Solution
<p>The following simultaneous contradictory settings: C6-05 is greater than 6 and C6-04 is greater than C6-03 (carrier frequency lower limit is greater than the upper limit). If C6-05 is less than or equal to 6, the drive operates at C6-03.</p>	<p>Correct the parameter settings.</p>
<p>Upper and lower limits between C6-02 and C6-05 contradict each other.</p>	

## 5.7 Diagnosing and Resetting Faults

When a fault occurs and the drive stops, follow the instructions below to remove whatever conditions triggered the fault, then restart the drive.

### ◆ Fault Occurs Simultaneously with Power Loss

**WARNING!** *Electrical Shock Hazard. Ensure there are no short circuits between the main circuit terminals (R/L1, S/L2, and T/L3) or between the ground and main circuit terminals before restarting the drive. Failure to comply may result in serious injury or death and will cause damage to equipment.*

1. Turn on the drive input power.
2. Remove the cause of the fault and reset.










**Note:**

- 1 To find out what faults were triggered, Check U2-02 (Fault History) to determine the faults that have been triggered.
- 2 If the fault continues to be displayed after cycling power, remove the cause of the fault and reset.

### ◆ If the Drive Still has Power After a Fault Occurs



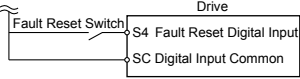
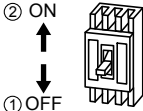
1. Look at the LED operator for information on the fault that occurred.
2. [Refer to Fault Displays, Causes, and Possible Solutions on page 130.](#)
3. Reset the fault. [Refer to Fault Reset Methods on page 150.](#)

### ◆ Viewing Fault History Data After Fault

	Step		Display/Result
1.	Turn on the drive input power. The first screen displays.	→	
2.	Press  until the monitor screen is displayed.	→	
3.	Press  to display the parameter setting screen.	→	
4.	Press  and > until U2-02 (Fault History) is displayed.	→	
5.	Press  to view previous fault (here, EF3).	→	

## 5.7 Diagnosing and Resetting Faults



### ◆ Fault Reset Methods

After the Fault Occurs	Procedure	
Fix the cause of the fault, restart the drive, and reset the fault	Press  on the digital operator.	
Fix the cause of the fault and reset via Fault Reset Digital Input S4.	Close then open the fault signal digital input via terminal S4. S4 is set fault reset as default (H1-04 = 12)	
If the above methods do not reset the fault, turn off the drive main power supply. Reapply power after LED operator display is out.		

## 5.8 Troubleshooting without Fault Display



This section describes troubleshooting problems that do not trip an alarm or fault.

### ◆ Cannot Change Parameter Settings

Cause	Possible Solutions
The drive is running the motor (i.e., the Run command is present).	<ul style="list-style-type: none"> <li>Stop the drive and switch over to the Programming Mode.</li> <li>Most parameters cannot be edited during run.</li> </ul>
The Access Level is set to restrict access to parameter settings.	<ul style="list-style-type: none"> <li>Set the Access Level to allow parameters to be edited (A1-01 = 2).</li> </ul>
The operator is not in the Parameter Setup Mode (the LED screen will display "PAr").	<ul style="list-style-type: none"> <li>See what mode the LED parameter is current set for.</li> <li>Parameters cannot be edited when in the Setup Mode ("STUP"). Switch modes so that "PAr" appears on the screen.</li> </ul>
The wrong password was entered.	<ul style="list-style-type: none"> <li>If the password entered to A1-04 does not match the password saved to A1-05, then drive settings cannot be changed.</li> <li>Reset the password.</li> <li>If you cannot remember the password: <ul style="list-style-type: none"> <li>Display parameter A1-04. Press the  button while pressing  at the same time. Parameter A1-05 will appear.</li> </ul> </li> <li>Set a new password to parameter A1-05.</li> </ul>
Undervoltage was detected.	<ul style="list-style-type: none"> <li>Check the drive input power voltage by looking at the DC bus voltage (U1-07).</li> <li>Check all main circuit wiring.</li> </ul>




### ◆ Motor Does Not Rotate Properly after Pressing RUN Button or after Entering External Run Command

#### ■ Motor Does Not Rotate

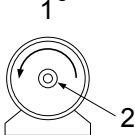
Cause	Possible Solutions
The drive is not in the Drive Mode.	<ul style="list-style-type: none"> <li>Check if the DRV light on the LED operator is lit.</li> <li>Enter the Drive Mode to begin operating the motor. <a href="#">Refer to The Drive and Programming Modes on page 79.</a></li> </ul>
 The button was pushed.	<p>Stop the drive and check if the correct frequency reference source is selected. If the operator keypad shall be the source, the LO/RE button LED must be on, if the source is REMOTE, it must be off. Take the following step to solve the problem:</p> <ul style="list-style-type: none"> <li>Push the  button.</li> </ul>
A Fast-Stop was executed and has not yet been reset.	Reset the Fast-Stop command.
Settings are incorrect for the source that provides the run command.	<p>Check parameter b1-02 (Run Command Selection). Set b1-02 so that it corresponds with the correct run command source.</p> <p>0: LED operator 1: Control circuit terminal (default setting) 2: MEMOBUS/Modbus communications</p>
There is faulty wiring in the control circuit terminals.	<ul style="list-style-type: none"> <li>Check the wiring for the control terminal.</li> <li>Correct wiring mistakes.</li> <li>Check the input terminal status monitor (U1-10).</li> </ul>
The drive has been set to accept the frequency reference from the incorrect source.	<p>Check parameter b1-01 (Frequency Reference Selection 1). Set b1-01 to the correct source of the frequency reference.</p> <p>0: LED operator 1: Control circuit terminal (default setting) 2: MEMOBUS/Modbus communications 3: Potentiometer (option)</p>
The terminal set to accept the main speed reference is set to the incorrect voltage and/or current.	<p>Check DIP switch S1. Next assign the correct input level to terminal A1 (H3-01). <a href="#">Refer to DIP Switch S1 Analog Input Signal Selection on page 62.</a></p>
Selection for the sink/source mode is incorrect.	Check DIP switch S3. <a href="#">Refer to Sinking/Sourcing Mode Switch on page 59.</a>
Frequency reference is too low.	<ul style="list-style-type: none"> <li>Check the frequency reference monitor (U1-01).</li> <li>Increase the frequency by changing the maximum output frequency (E1-09).</li> </ul>
Multi-function analog input is set up to accept gain for the frequency reference, but no voltage (current) has been provided.	<ul style="list-style-type: none"> <li>Check the multi-function analog input settings.</li> <li>Check if H3-02 has been set to the proper values.</li> <li>Check if the analog input value has been set properly.</li> </ul>



## 5.8 Troubleshooting without Fault Display

Cause	Possible Solutions
The  button was pressed when the drive was started from a REMOTE source.	<ul style="list-style-type: none"> <li>When the  button is pressed, the drive will decelerate to stop.</li> <li>Switch off the run command and then re-enter a run command.</li> <li>The  button is disabled when o2-02 is set to 0.</li> </ul>
Motor is not producing enough torque.	<ul style="list-style-type: none"> <li>Ensure the selected V/f pattern corresponds with the characteristics of the motor being used.</li> <li>Increase both the minimum and mid output frequency voltages (E1-08, E1-10).</li> </ul> <p>Increase the frequency reference so that it is higher than the minimum frequency reference (E1-09).</p> <p>Increase the torque compensation gain (C4-01).</p>
The drive is set for both 2-Wire and 3-Wire sequence at the same time.	<ul style="list-style-type: none"> <li>The drive is set for a 3-Wire sequence when one of the parameters H1-03 through H1-05 is set to 0.</li> <li>If the drive is supposed to be set up for a 2-Wire sequence, then ensure parameters H1-03 through H1-05 are not set to 0.</li> <li>If the drive is supposed to be set up for a 3-Wire sequence, then H1-□□ must be set to 0.</li> </ul>

### ■ Motor Rotates in the Opposite Direction from the Run Command

Cause	Possible Solutions
Phase wiring between the drive and motor is incorrect.	<ul style="list-style-type: none"> <li>Check the motor wiring.</li> <li>Switch two motor cables (U, V, and W) to reverse motor direction.</li> <li>Connect drive output terminals U/T1, V/T2 and W/T3 in the right order to the corresponding motor terminals U, V, and W.</li> <li>Change the setting of parameter b1-14.</li> </ul>
The forward direction for the motor is setup incorrectly.	<p>Typically, forward is designated as being counterclockwise when looking from the motor shaft (refer to the figure below).</p>  <p><b>1. Forward Rotating Motor (looking down the motor shaft)</b>  <b>2. Motor Shaft</b></p>

**Note:** Check the motor specifications for the forward and reverse directions. The motor specifications will vary depending on the manufacturer of the motor.

## 5.8 Troubleshooting without Fault Display

### ■ Motor is Too Hot

Cause	Possible Solutions
The load is too heavy.	<p>If the load is too heavy for the motor, the motor will overheat as it exceeds its rated torque value for an extended period of time. Keep in mind that the motor also has a short-term overload rating in addition to the possible solutions provided below:</p> <ul style="list-style-type: none"> <li>• Reduce the load.</li> <li>• Increase the acceleration and deceleration times.</li> <li>• Check the values set for the motor protection (L1-01, L1-02) as well as the motor rated current (E2-01).</li> <li>• Increase motor capacity.</li> </ul>
The air around the motor is too hot.	<ul style="list-style-type: none"> <li>• Check the ambient temperature.</li> <li>• Cool the area until it is within the specified temperature range.</li> </ul>
Insufficient voltage insulation between motor phases.	<p>When the motor is connected to terminals U/T1, V/T2, and W/T3, voltage surges occur between the motor coils and drive switching. Normally, surges can reach up to three times the drive input power supply voltage (600 V for 200 V class, and 1200 V for 400 V class).</p> <ul style="list-style-type: none"> <li>• Use a motor with voltage tolerance higher than the max voltage surge.</li> <li>• Use a motor designed to work specifically with a drive when using a 400 V class unit.</li> <li>• Install an AC reactor on the output side of the drive.</li> </ul>
The motor fan has stopped or is clogged.	Check the motor fan.

### ■ oPE02 Error Occurs when Lowering the Motor Rated Current Setting

Cause	Possible Solutions
The motor rated current and the motor no-load current settings in the drive are incorrect.	<p>The user is trying to set the motor rated current in E2-01 to a value lower than the no-load current set in E2-03.</p> <ul style="list-style-type: none"> <li>• Make sure that value set in E2-01 is higher than E2-03. Setting E2-01 &lt; E2-03 will trigger an oPE02 error.</li> <li>• If it is necessary to set E2-01 lower than E2-03, first lower the value set to E2-03, then change the setting in E2-01 as needed.</li> </ul>

### ■ Motor Stalls During Acceleration or With Large Loads

Cause	Possible Solutions
Load is too heavy.	<p>Take the following steps to resolve the problem:</p> <ul style="list-style-type: none"> <li>• Reduce the load.</li> <li>• Increase the acceleration time.</li> <li>• Increase motor capacity.</li> <li>• Although the drive has a Stall Prevention function and a Torque Compensation Limit function, accelerating too quickly or trying to drive an excessively large load can exceed the capabilities of the motor.</li> </ul>

### ■ Motor Will Not Accelerate or the Acceleration Time is Too Long

Cause	Possible Solutions
Frequency reference is too low.	<ul style="list-style-type: none"> <li>Check the maximum output frequency (E1-04).</li> <li>Increase E1-04 if it is set too low.</li> </ul>
	Check U1-01 for proper frequency reference.
	Check if a frequency reference signal switch has been set to one of the multi-function input terminals.
	Check for low gain level set to terminal A1 (H3-03).
Load is too heavy.	<ul style="list-style-type: none"> <li>Reduce the load so that the output current remains within the motor-rated current.</li> <li>In extruder and mixer applications, the load will sometimes increase as the temperature drops.</li> </ul>
	Check if the mechanical brake is fully releasing as it should.
Acceleration time has been set too long.	Check if the acceleration time parameters have been set too long (C1-01, -03).
Motor characteristics and drive parameter settings are incompatible with one another in V/f Control.	<ul style="list-style-type: none"> <li>Set the correct V/f pattern so that it matches the characteristics of the motor being used.</li> <li>Check the motor data and adjust V/f pattern settings.</li> </ul>
Incorrect frequency reference setting.	<ul style="list-style-type: none"> <li>Check the multi-function analog input settings.</li> <li>Ensure the analog input value is set to the right value (U1-13).</li> </ul>
The Stall Prevention level during acceleration and deceleration set too low.	<ul style="list-style-type: none"> <li>Check the Stall Prevention level during acceleration (L3-02).</li> <li>If L3-02 is set too low, acceleration will take a fair amount of time.</li> <li>Increase L3-02.</li> </ul>
The Stall Prevention level during run has been set too low.	<ul style="list-style-type: none"> <li>Check the Stall Prevention level during run (L3-06).</li> <li>If L3-06 is set too low, speed will drop as the drive outputs torque.</li> <li>Increase the setting value.</li> </ul>

### ■ Drive Frequency Reference Differs from the Controller Frequency Reference Command

Cause	Possible Solutions
The analog input frequency gain and bias are set to incorrect values.	Check the frequency reference terminal input gain level assigned to terminal A1 (parameter H3-03).

### ■ Poor Speed Control Accuracy

Cause	Possible Solutions
Slip compensation function disabled or set up incorrectly.	Adjust the slip compensation gain (C3-01).

## 5.8 Troubleshooting without Fault Display

### ■ Deceleration Takes Longer Than Expected when Using a Braking Resistor

Cause	Possible Solutions
L3-04 is set incorrectly.	<ul style="list-style-type: none"> <li>Check the Stall Prevention Level during deceleration (L3-04).</li> <li>If a braking resistor option has been installed, disable Stall Prevention during deceleration (L3-04 = "0").</li> </ul>
The deceleration time is set too long.	Set deceleration to more appropriate time (C1-02 and C1-04).
Insufficient motor torque.	<ul style="list-style-type: none"> <li>Assuming parameter settings are normal and that no overvoltage occurs when there is insufficient torque, it is likely that the demand on the motor has exceeded the motor capacity.</li> <li>Use a larger motor.</li> </ul>
Load exceeded the internal torque limit determined by the drive rated current.	Switch to a larger capacity drive.

### ■ Motor Hunting Occurs When Operating With a Light Load

Cause	Possible Solutions
Carrier frequency is too high.	Lower the carrier frequency setting C6-02.
Large V/f setting value at low speeds triggers overexcitation.	<ul style="list-style-type: none"> <li>Use parameters E1-04 through E1-10 to set the V/f pattern in relation to the load characteristics.</li> </ul>
The maximum output frequency and the base frequency reference are not set properly in relationship to each other.	Set the proper values for the maximum output frequency and base frequency (E1-04, E1-06).
Hunting Prevention is set up incorrectly.	Adjust the hunting prevention gain (n1-02).

### ■ Noise From Drive or Output Lines When the Drive is Powered On

Cause	Possible Solutions
Relay switching in the drive generates excessive noise.	<ul style="list-style-type: none"> <li>Lower the carrier frequency (C6-02).</li> <li>Install a noise filter on the input side of drive input power.</li> <li>Install a noise filter on the output side of the drive.</li> <li>Place the wiring inside a metal conduit to shield it from switching noise.</li> <li>Ground the drive and motor properly.</li> <li>Separate the main circuit wiring and the control lines.</li> </ul>

### ■ Ground Fault Circuit Interrupter (GFCI) Trips During Run

Cause	Possible Solutions
Excessive leakage current trips MCCB.	<ul style="list-style-type: none"> <li>Increase the GFCI sensitivity or use GFCI with a higher threshold.</li> <li>Lower the carrier frequency (C6-02).</li> <li>Reduce the length of the cable used between the drive and the motor.</li> <li>Install a noise filter or reactor on the output side of the drive.</li> </ul>

## ■ Connected Machinery Vibrates When Motor Rotates

### Excessive Motor Oscillation and Erratic Rotation

Cause	Possible Solutions
Poor balance between motor phases.	Check drive input power voltage to ensure that it provides stable power.

### Unexpected Noise from Connected Machinery

Cause	Possible Solutions
The carrier frequency is at the resonant frequency of the connected machinery.	Adjust the carrier frequency using parameters C6-02 through C6-05.
The drive output frequency is the same as the resonant frequency of the connected machinery.	<ul style="list-style-type: none"> <li>Adjust the parameters used for the Jump Frequency function (d3-01 through d3-04) to skip the problem-causing bandwidth.</li> <li>Place the motor on a rubber pad to reduce vibration.</li> </ul>

**Note:** The drive may have trouble assessing the status of the load due to white noise generated when using Swing PWM (C6-02 = 7).

## ■ Oscillation or Hunting

Cause	Possible Solutions
Insufficient tuning.	Adjust Hunting prevention Gain Setting (n1-02).
The frequency reference is assigned to an external source and the signal is noisy.	<ul style="list-style-type: none"> <li>Ensure that noise is not affecting the signal lines.</li> <li>Separate main circuit wiring and control circuit wiring.</li> <li>Use twisted-pair cables or shielded wiring for the control circuit.</li> <li>Increase the analog input time filter constant (H3-13).</li> </ul>
The cable between the drive and motor is too long.	<ul style="list-style-type: none"> <li>Reduce the length of the cable.</li> </ul>

## ■ Motor Rotates After the Drive Output is Shut Off

Cause	Possible Solutions
Low DC Injection Braking and the drive cannot decelerate properly.	<ul style="list-style-type: none"> <li>Adjust the DC Injection braking settings.</li> <li>Increase the value of b2-02 (DC Injection Braking Current).</li> <li>Increase the b2-04 (DC Injection Braking Time at Stop).</li> </ul>

## ■ Over Speed Loss Occurs When Starting into a Rotating Load

Cause	Possible Solutions
The load is already rotating when the drive is trying to start it.	<ul style="list-style-type: none"> <li>Stop the motor using DC Injection braking. Restart the motor.</li> <li>Increase the value of b2-03 (DC Injection Braking Time at start).</li> <li>Set a multi-function input terminal for external Speed Search command (H1-□□="61" or "62" during restart).</li> </ul>

## 5.8 Troubleshooting without Fault Display

### ■ Output Frequency is not as High as Frequency Reference

Cause	Possible Solutions
Frequency reference is set within the range of the Jump Frequency.	<ul style="list-style-type: none"><li>Adjust the parameters used for the Jump Frequency function (d3-01, d3-02).</li><li>Enabling the Jump Frequency prevents the drive from outputting the frequencies specified in the Jump Frequency range.</li></ul>
Upper limit for the frequency reference has been exceeded.	<ul style="list-style-type: none"><li>Set the maximum output frequency and the upper limit for the frequency reference to more appropriate values (E1-04, d2-01).</li><li>The following calculation yields the upper value for the output frequency = <math>E1-04 \times d2-01 / 100</math></li></ul>
Large load triggered Stall Prevention function during acceleration.	<ul style="list-style-type: none"><li>Reduce the load.</li><li>Adjust the Stall Prevention level during acceleration (L3-02).</li></ul>

### ■ Buzzing Sound from Motor at 2 kHz

Cause	Possible Solutions
Exceeded 110% of the rated output current of the drive while operating at low speeds.	<ul style="list-style-type: none"><li>If the output current rises too high at low speeds, the carrier frequency automatically reduces and causes a whining or buzzing sound.</li><li>If the sound is coming from the motor, disable carrier frequency derating (L8-38 = "0").</li><li>Disabling the automatic carrier frequency derating increases the chances of an overload fault (oL2). Switch to a larger capacity motor if oL2 faults occur too frequently.</li></ul>

### ■ Motor Does Not Operate When the RUN Button on the Digital Operator is Pressed

Cause	Possible Solutions
The LOCAL/REMOTE mode is not selected properly.	Press the LOCAL/REMOTE button to switch. The LO/RE LED should be on for LOCAL mode.
The drive is not in drive mode.	A run command will not be issued. Exit to the drive mode and cycle the run command.
The frequency reference is too low.	<ul style="list-style-type: none"><li>If the frequency reference is set below the frequency set in E1-09 (Minimum Output Frequency), the drive will not operate.</li><li>Raise the frequency reference to at least the minimum output frequency.</li></ul>

### ■ Motor Does Not Operate When an External Run Command is Input

Cause	Possible Solutions
The LOCAL/REMOTE mode is not selected properly.	Press the LOCAL/REMOTE button to switch. The LO/RE LED should be off for REMOTE mode.
The drive is not in Drive Mode.	A run command will not be issued. Exit to the Drive mode and cycle the run command.

## 5.8 Troubleshooting without Fault Display

Cause	Possible Solutions
The frequency reference is too low.	<ul style="list-style-type: none"> <li>If the frequency reference is set below the frequency set in E1-09 (Minimum Output Frequency), the drive will not operate.</li> <li>Raise the frequency reference to at least the minimum output frequency.</li> </ul>

### ■ Motor Stops During Acceleration or When a Load is Connected

Cause	Possible Solution
<ul style="list-style-type: none"> <li>The load is too heavy.</li> <li>The limit of motor response may be reached during rapid acceleration. This may be a result of improper stall prevention or automatic torque boost function adjustment.</li> </ul>	Increase the acceleration time (C1-01) or reduce the motor load. Also, consider increasing the motor size and/or drive size.

### ■ Motor Rotates in One Direction Only

Cause	Possible Solutions
"Reverse run prohibited" is selected. If b1-04 (Reverse Prohibit Operation) is set to 1 (reverse run prohibited), the drive will not accept a reverse run command.	Set b1-04 = "0" to allow reverse run operation.
The drive prohibits reverse rotation.	<ul style="list-style-type: none"> <li>Check parameter b1-04.</li> <li>Set the drive to allow the motor to rotate in reverse (b1-04 = "0").</li> </ul>
A Reverse run signal has not been entered, although 3-Wire sequence is selected.	<ul style="list-style-type: none"> <li>Make sure that one of the input terminals S3 to S5 used for the 3-Wire sequence has been set for reverse.</li> </ul>

### ■ Peripheral Devices Affected by Drive Operation

Cause	Possible Solutions
Radio frequency interference may be generated by drive output PWM waveform.	<ul style="list-style-type: none"> <li>Change the Carrier Frequency Selection (C6-02) to lower the carrier frequency. This will help to reduce the amount of transistor switching noise.</li> <li>Install an Input Noise Filter at the input power terminals.</li> <li>Install an Output Noise Filter at the motor terminals.</li> <li>Use conduit. Metal can shield electrical noise.</li> <li>Ground the drive and motor.</li> <li>Separate main circuit wiring from control wiring.</li> </ul>

## 5.8 Troubleshooting without Fault Display

---

### ■ Ground Fault Interrupter Activates When Drive is Running

Cause	Possible Solutions
<p>The output of the drive is a series of high frequency pulses (PWM), so there is a certain amount of leakage current. This may cause the ground fault interrupter to operate and cut off the drive input power.</p>	<ul style="list-style-type: none"><li>• Change to a ground fault interrupter with a higher leakage current detection level (such as, a sensitivity current of 200 mA or greater per Unit, with an operating time of 0.1 s or more), or one that incorporates high-frequency corrective actions.</li><li>• Change the Carrier Frequency Selection (C6-02) to lower the carrier frequency. <b>Note:</b> Leakage current increases in proportion to cable length.</li></ul>



# 6

## Periodic Inspection & Maintenance

---

This chapter describes the periodic inspection and maintenance of the drive to ensure that it receives the proper care to maintain overall performance.

<b>6.1</b>	<b>SECTION SAFETY.....</b>	<b>162</b>
<b>6.2</b>	<b>INSPECTION.....</b>	<b>165</b>
<b>6.3</b>	<b>PERIODIC MAINTENANCE.....</b>	<b>168</b>
<b>6.4</b>	<b>DRIVE COOLING FANS.....</b>	<b>171</b>

# 6.1 Section Safety

### DANGER

#### **Electrical Shock Hazard**

**Do not connect or disconnect wiring while the power is on.**

Failure to comply will result in death or serious injury.

### WARNING

#### **Electrical Shock Hazard**

**Do not operate equipment with covers removed.**

Failure to comply could result in death or serious injury.

The diagrams in this section may show drives without covers or safety shields to show details. Be sure to reinstall covers or shields before operating the drives and run the drives according to the instructions described in this manual.

**Always ground the motor-side grounding terminal.**

Improper equipment grounding could result in death or serious injury by contacting the motor case.

**Do not remove covers or touch circuit boards while the power is on.**

Failure to comply could result in death or serious injury.

**Do not allow unqualified personnel to perform work on the drive.**

Failure to comply could result in death or serious injury.

Installation, maintenance, inspection, and servicing must be performed only by authorized personnel familiar with installation, adjustment, and maintenance of AC drives.

**Do not perform work on the drive while wearing loose clothing, jewelry or without eye protection.**

Failure to comply could result in death or serious injury.

Remove all metal objects such as watches and rings, secure loose clothing, and wear eye protection before beginning work on the drive.

 **WARNING****Do not touch any terminals before the capacitors have fully discharged.**

Failure to comply could result in death or serious injury.

Before wiring terminals, disconnect all power to the equipment. The internal capacitor remains charged even after the power supply is turned off. The charge indicator LED will extinguish when the DC bus voltage is below 50 Vdc. To prevent electric shock, wait at least one minute after all indicators are off and measure the DC bus voltage level to confirm safe level.

**Fire Hazard****Tighten all terminal screws to the specified tightening torque.**

Loose electrical connections could result in death or serious injury by fire due to overheating of electrical connections.

**Do not use an improper voltage source.**

Failure to comply could result in death or serious injury by fire.

Verify that the rated voltage of the drive matches the voltage of the incoming power supply before applying power.

**Do not use improper combustible materials.**

Failure to comply could result in death or serious injury by fire.

Attach the drive to metal or other noncombustible material.

### NOTICE

**Observe proper electrostatic discharge procedures (ESD) when handling the drive and circuit boards.**

Failure to comply may result in ESD damage to the drive circuitry.

**Never connect or disconnect the motor from the drive while the drive is outputting voltage.**

Improper equipment sequencing could result in damage to the drive.

**Do not use unshielded cable for control wiring.**

Failure to comply may cause electrical interference resulting in poor system performance. Use shielded, twisted-pair wires and ground the shield to the ground terminal of the drive.

**Do not allow unqualified personnel to use the product.**

Failure to comply could result in damage to the drive or braking circuit.

Carefully review instruction manual TOBPC72060000 when connecting a braking option to the drive.

**Do not modify the drive circuitry.**

Failure to comply could result in damage to the drive and will void warranty.

Yaskawa is not responsible for any modification of the product made by the user. This product must not be modified.

**Check all the wiring to ensure that all connections are correct after installing the drive and connecting any other devices.**

Failure to comply could result in damage to the drive.

## 6.2 Inspection

Power electronics have limited life and may exhibit changed characteristics or performance deterioration after years of use under normal conditions. To help avoid such problems, it is important to perform preventive maintenance and periodic inspection on the drive.

Drives contain a variety of power electronics such as power transistors, semiconductors, capacitors, resistors, fans, and relays. The electronics in the drive serve a critical role in maintaining proper motor control.

Follow the inspection lists provided in this chapter as a part of a regular maintenance program.

**Note:** The drive will require more frequent inspection if it is placed in harsh environments, such as:

- High ambient temperatures
- Frequent starting and stopping
- Fluctuations in the AC supply or load
- Excessive vibrations or shock loading
- Dust, metal dust, salt, sulfuric acid, chlorine atmospheres
- Poor storage conditions.

Perform the first equipment inspection 3 months after installation.

### ◆ Recommended Daily Inspection

**Table 6.1** outlines the recommended daily inspection for Yaskawa drives. Check the following items on a daily basis to avoid premature deterioration in performance or product failure. Copy this checklist and mark the “Checked” column after each inspection.

**WARNING! Electrical Shock Hazard.** Do not connect or disconnect wiring while the power is on. Failure to comply can result in serious personal injury. Before servicing the drive, disconnect all power to the equipment. The internal capacitor remains charged even after the power supply is turned off. The charge indicator LED will extinguish when the DC bus voltage is below 50 Vdc. To prevent electric shock, wait at least one minute after all indicators are OFF and measure the DC bus voltage level to confirm safe level.

**Table 6.1 General Recommended Daily Inspection Checklist**

Inspection Category	Inspection Points	Corrective Action	Checked
Motor	<ul style="list-style-type: none"> <li>• Inspect for abnormal oscillation or noise coming from the motor.</li> </ul>	<ul style="list-style-type: none"> <li>• Check the load coupling.</li> <li>• Measure motor vibration.</li> <li>• Tighten all loose components.</li> </ul>	
Cooling	<ul style="list-style-type: none"> <li>• Inspect for abnormal heat generated from the drive or motor and visible discoloration.</li> </ul>	<ul style="list-style-type: none"> <li>• Check for excessive load.</li> <li>• Loose connections</li> <li>• Check for dirty heatsink or motor.</li> <li>• Ambient temperature</li> </ul>	

## 6.2 Inspection

Inspection Category	Inspection Points	Corrective Action	Checked
Cooling Fan	<ul style="list-style-type: none"> <li>Inspect drive cooling fan operation.</li> </ul>	<ul style="list-style-type: none"> <li>Check for clogged or dirty fan.</li> <li>Check fan operation drive parameter.</li> </ul>	
Environment	<ul style="list-style-type: none"> <li>Verify the drive environment complies with the specifications listed in the Installation section of this manual.</li> </ul>	<ul style="list-style-type: none"> <li>Eliminate the source of contaminants or correct poor environment.</li> </ul>	
Load	<ul style="list-style-type: none"> <li>The drive output current should not be higher than the motor or drive rating for an extended period of time.</li> </ul>	<ul style="list-style-type: none"> <li>Check for excessive load.</li> <li>Check the motor parameter settings of the drive.</li> </ul>	
Power Supply Voltage	<ul style="list-style-type: none"> <li>Check main power supply and control voltages.</li> </ul>	<ul style="list-style-type: none"> <li>Correct the voltage or power supply to within nameplate specifications.</li> <li>Verify all main circuit phases.</li> </ul>	

### ◆ Recommended Periodic Inspection

**Table 6.2** outlines the recommended periodic inspections for Yaskawa drive installations. Periodic inspections should generally be checked every 3-6 months; however, the drive may require more frequent inspection due to poor environments or rigorous use. Operating and environmental conditions, along with experience in each application, will determine the actual inspection frequency for each installation. Periodic inspection will help to avoid premature deterioration in performance or product failure. Copy this checklist and mark the “Checked” column after each inspection.

### ■ Periodic Inspection

**WARNING! Electrical Shock Hazard.** Do not connect or disconnect wiring while the power is on. Failure to comply can result in serious personal injury. Before servicing the drive, disconnect all power to the equipment. The internal capacitor remains charged even after the power supply is turned off. The charge indicator LED will extinguish when the DC bus voltage is below 50 Vdc. To prevent electric shock, wait at least one minute after all indicators are OFF and measure the DC bus voltage level to confirm safe level.

**Table 6.2 Periodic Inspection Checklist**

Inspection Area	Inspection Points	Corrective Action	Checked
<b>Main Circuit Periodic Inspection</b>			
General	<ul style="list-style-type: none"> <li>Inspect equipment for discoloration from overheating or deterioration.</li> <li>Inspect for damaged or deformed parts.</li> </ul>	<ul style="list-style-type: none"> <li>Replace damaged components as required.</li> <li>The drive has few serviceable parts and may require complete drive replacement.</li> </ul>	
	<ul style="list-style-type: none"> <li>Inspect for dirt, foreign particles, or dust collection on components.</li> </ul>	<ul style="list-style-type: none"> <li>Inspect enclosure door seal if present. Replace components if cleaning is not possible.</li> <li>Remove foreign particles and dust with a vacuum cleaner to avoid touching parts.</li> </ul>	

Inspection Area	Inspection Points	Corrective Action	Checked
<b>Conductors and Wiring</b>	<ul style="list-style-type: none"> <li>Inspect wiring and connections for discoloration, damage, or heat stress.</li> <li>Inspect wire insulation and shielding for wear.</li> </ul>	<ul style="list-style-type: none"> <li>Repair or replace damaged wiring.</li> </ul>	
<b>Terminals</b>	<ul style="list-style-type: none"> <li>Inspect terminals for stripped, damaged, or loose connections.</li> </ul>	<ul style="list-style-type: none"> <li>Tighten loose screws and replace damaged screws or terminals.</li> </ul>	
<b>Relays and Contactors</b>	<ul style="list-style-type: none"> <li>Inspect contactors and relays for excessive noise during operation.</li> <li>Inspect coils for signs of overheating such as melted or cracked insulation.</li> </ul>	<ul style="list-style-type: none"> <li>Check coil voltage for over or under voltage conditions.</li> <li>Replace damaged removable relays contactors or circuit board.</li> </ul>	
<b>Braking Resistors</b>	<ul style="list-style-type: none"> <li>Inspect for discoloration of heat stress on or around resistors.</li> </ul>	<ul style="list-style-type: none"> <li>Minor discoloration may be acceptable.</li> <li>If discoloration exists check for loose connections.</li> </ul>	
<b>Control Circuit Periodic Inspection</b>			
<b>General</b>	<ul style="list-style-type: none"> <li>Inspect terminals for stripped, damaged or loose connections.</li> <li>Check for tightness.</li> </ul>	<ul style="list-style-type: none"> <li>Tighten loose screws and replace damaged screws or terminals.</li> <li>If terminals are integral to a circuit board then board or drive replacement may be required.</li> </ul>	
<b>LED Periodic Inspection</b>			
<b>LEDs</b>	<ul style="list-style-type: none"> <li>Make sure the LED lights correctly.</li> <li>Inspect for dust or other foreign material that may have collected on surrounding components.</li> </ul>	<ul style="list-style-type: none"> <li>Contact your Yaskawa representative if there is any trouble with the LED or keypad.</li> <li>Clean the LED.</li> </ul>	
<b>Cooling System Periodic Inspection</b>			
<b>Cooling Fan</b>	<ul style="list-style-type: none"> <li>Check for abnormal oscillation or unusual noise.</li> <li>Check for damaged or missing fan blades.</li> </ul>	<ul style="list-style-type: none"> <li>Replace as required.</li> <li><i>Refer to Drive Cooling Fans on page 171</i> for information on cleaning or replacing the cooling fan.</li> </ul>	
<b>Heatsink</b>	<ul style="list-style-type: none"> <li>Inspect for dust or other foreign material collected on the surface.</li> </ul>	<ul style="list-style-type: none"> <li>Remove foreign particles and dust with a vacuum cleaner to avoid touching parts.</li> </ul>	
<b>Air Duct</b>	<ul style="list-style-type: none"> <li>Inspect air intake and exhaust openings. They must be free from obstruction and properly installed.</li> </ul>	<ul style="list-style-type: none"> <li>Visually inspect the area.</li> <li>Clear obstructions and clean air duct as required.</li> </ul>	
<b>Motor Periodic Inspection</b>			
<b>Operation Check</b>	<ul style="list-style-type: none"> <li>Check for increased vibration or abnormal noise.</li> </ul>	<ul style="list-style-type: none"> <li>Stop the motor and contact qualified maintenance personnel as required.</li> </ul>	

**Note:** Periodic inspections should be performed every one or two years. The drive, however, may require more frequent inspection due to poor environments or rigorous use.

### 6.3 Periodic Maintenance

The drive has various "maintenance monitors." This feature provides advance maintenance warning and eliminates the need to shut down the entire system for unexpected problems. The drive allows the user to check the following maintenance periods.

- Cooling Fan
- Electrolytic Capacitors (Main Circuit)
- Inrush Prevention Circuit
- IGBT

#### ◆ Replacement Parts

**Table 6.3** contains the estimated performance life of components that require replacement during the life of the drive. Only use Yaskawa replacement parts for the appropriate drive model and revision.

**Table 6.3 Estimated Performance Life**

Component	Estimated Performance Life
Cooling Fan	2 ~ 3 years
Electrolytic Capacitors (Main Circuit)	10 years <1>

<1> The drive has few serviceable parts and may require complete drive replacement.

**NOTICE:** *Estimated performance life based on specific usage conditions. These conditions are provided for the purpose of replacing parts to maintain performance. Some parts may require more frequent replacement due to poor environments or rigorous use.*

*Usage conditions for estimated performance life:*

- Ambient temperature: Yearly average of 30 °C
- Load factor: 80% maximum
- Operation time: 12 hours a day

#### ■ Performance Life Monitors

The drive calculates the maintenance period for components that may require replacement during the life of the drive. A percentage of the maintenance period is displayed on the LED digital operator by viewing the appropriate monitor parameter.

When the maintenance period reaches 100%, there is increased risk that the drive may malfunction. Yaskawa recommends checking the maintenance period regularly to ensure maximum performance life.

**Refer to Recommended Periodic Inspection on page 166** for more details.



**Table 6.4 Performance Life Monitors Used for Component Replacement**

Parameter	Component	Contents
U4-04	Cooling Fan	Displays the accumulated cooling fan operation time as a percentage of the specified maintenance period (displayed in percent %).
U4-05	Main Circuit (DC bus) Electrolytic Capacitors	Displays the accumulated time the capacitors are used as a percentage of the specified maintenance period.
U4-06	Inrush (pre-charge) relay	Displays the number of times the drive is powered up as a percentage of the performance life of the inrush circuit.
U4-07	IGBT	Displays the percentage of the maintenance period reached by the IGBTs.

### ■ Alarm Outputs for Maintenance Monitors

An output can be set up to inform the user when a specific components has neared its expected performance life.

When one of multi-function digital output terminals has been assigned the maintenance monitor function (H2-□□ = 2F), the terminal will close when the cooling fan, DC bus capacitors, or DC bus pre-charge relay reach 90% of the expected performance life, or when the IGBTs have reached 50% of their expected performance life. Additionally the digital operator will display an alarm like shown in [Table 6.5](#) to indicate the specific components that may need maintenance.

**Table 6.5 Maintenance Alarms**

Digital Operator Alarm Display		Function	Corrective Action
LT-1 <I>	LT-1	The cooling fans have reached 90% of their designated life time.	Replace the cooling fan.
LT-2 <I>	LT-2	The DC bus capacitors have reached 90% of their designated life time.	Contact a Yaskawa representative or the nearest Yaskawa sales office on possible drive replacement.
LT-3 <I>	LT-3	The DC bus charge circuit has reached 90% of its designated life time.	Contact a Yaskawa representative or the nearest Yaskawa sales office on possible drive replacement.
LT-4 <I>	LT-4	The IGBTs have reached 50% of their designated life time.	Check the load, carrier frequency, and output frequency.
TrPC <I>	TrPC	The IGBTs have reached 90% of their designated life time.	Contact a Yaskawa representative or the nearest Yaskawa sales office on possible drive replacement.

<I> This alarm message will be output only if the Maintenance Monitor function is assigned to one of the digital outputs (H2-□□ = 2F). The alarm will also trigger a digital output that is programmed for alarm indication (H2-□□ = 10).

## 6.3 Periodic Maintenance

---

<2> This alarm message will always be output, even if the Maintenance Monitor function is not assigned to any of the digital outputs (H2-□□ = 2F). The alarm will also trigger a digital output that is programmed for alarm indication (H2-□□ = 10).

### ■ Related Drive Parameters

Use parameters o4-03, o4-05, o4-07, and o4-09 to reset a Maintenance Monitor to zero after replacing a specific component. *Refer to Parameter List on page 213* for details on parameter settings.

**NOTICE:** *If these parameters are not reset after the corresponding parts have been replaced, the Maintenance Monitor function will continue to count down the performance life from the value that was reached with the old part. If the Maintenance Monitor is not reset, the drive will not have the correct value of the performance life for the new component.*

## 6.4 Drive Cooling Fans

**NOTICE:** Follow cooling fan replacement instructions. The cooling fan cannot operate properly when installed incorrectly and could seriously damage the drive. To ensure maximum useful product life, replace all cooling fans when performing maintenance.

Contact your Yaskawa representative or supplier to order replacement cooling fans as required.

### ◆ Number of Cooling Fans

Drive Model	Cooling Fans
<b>Single-Phase 200 V Class</b>	
BA0001	–
BA0002	–
BA0003	–
BA0006	–
BA0010	1
<b>Three-Phase 200 V Class</b>	
2A0001	–
2A0002	–
2A0004	–
2A0006	1
2A0010	1
2A0012	1
2A0020	1
<b>Three-Phase 400 V Class</b>	
4A0001	–
4A0002	–
4A0004	–
4A0005	1
4A0007	1
4A0009	1
4A0011	1

### ◆ Cooling Fan Replacement

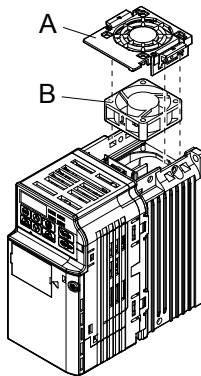
The cooling fan is installed on the top of the drive. The cooling fan can easily be replaced without tools or removal of the drive or enclosure parts.

**WARNING!** *Electrical Shock Hazard. Do not connect or disconnect wiring while the power is on. Failure to comply can result in serious personal injury. Before servicing the drive, disconnect all power to the equipment. The internal capacitor remains charged even after the power supply is turned off. The charge indicator LED will extinguish when the DC bus voltage is below 50 Vdc. To prevent electric shock, wait at least one minute after all indicators are OFF and measure the DC bus voltage level to confirm safe level.*

**CAUTION!** *Burn Hazard. Do not touch a hot drive heatsink. Failure to comply could result in minor or moderate injury. Shut off the power to the drive when replacing the cooling fan. To prevent burns, wait at least 15 minutes and ensure the heatsink has cooled down.*

### ■ Removing the Cooling Fan

1. Depress the right and left sides of the fan cover tabs and pull upward. Remove the fan cover from the top of the drive. The following figure illustrates a drive with a single cooling fan.



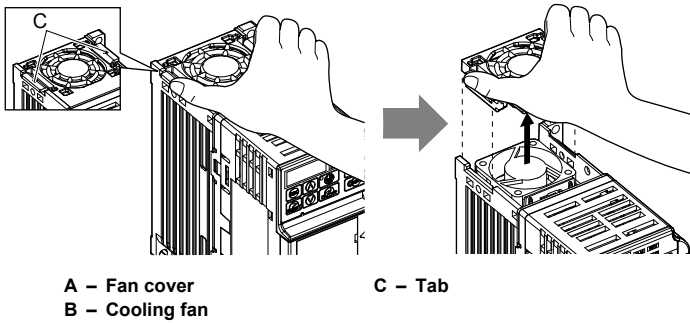


Figure 6.1 Remove the Cooling Fan Cover

2. Remove the fan cable carefully, disconnect the pluggable connector and remove the fan.

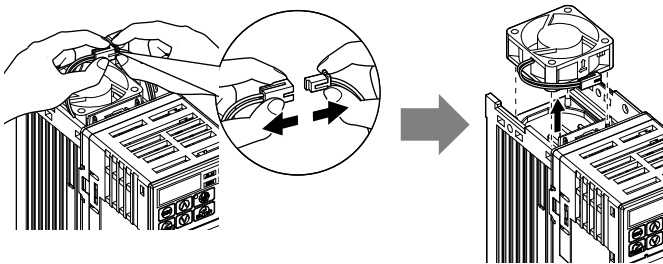


Figure 6.2 Disconnect and Remove the Fan

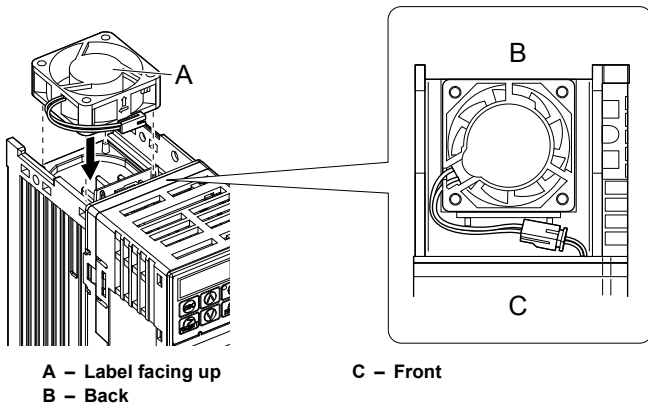
## 6.4 Drive Cooling Fans

---

### ■ Installing the Cooling Fan

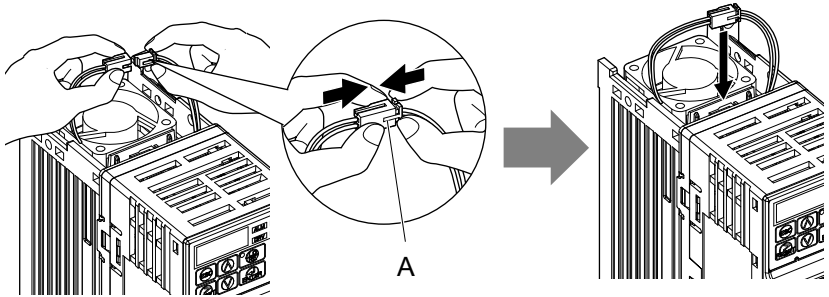
**NOTICE:** *Prevent Equipment Damage. Follow cooling fan replacement instructions. Improper cooling fan replacement could result in damage to equipment. When installing the replacement cooling fan into the drive, make sure the fan is facing upwards. To ensure maximum useful product life, replace all cooling fans when performing maintenance.*

1. Install the replacement cooling fan into the drive, ensuring the alignment pins line up, as shown in the figure below:



**Figure 6.3 Cooling Fan Orientation**

2. Ensure the connectors are properly connected and place the cable back into the recess of the drive.

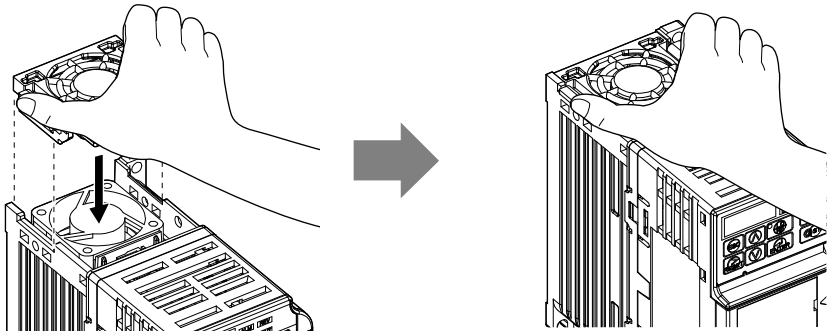


**A** – Push the connectors together so no space remains between them.

**Figure 6.4** Connectors

**Note:** Ensure that the left and right tabs are locked back into place.

3. Align the left and right cover tabs to install the fan cover back on the top of the drive.



**Figure 6.5** Installation

**This Page Intentionally Blank**



# 7

## Peripheral Devices & Options

---

This chapter explains the installation of available peripheral devices and options for the drive.

<b>7.1</b>	<b>SECTION SAFETY.....</b>	<b>178</b>
<b>7.2</b>	<b>DRIVE OPTIONS AND PERIPHERAL DEVICES.....</b>	<b>180</b>
<b>7.3</b>	<b>CONNECTING PERIPHERAL DEVICES.....</b>	<b>182</b>
<b>7.4</b>	<b>INSTALLING PERIPHERAL DEVICES.....</b>	<b>184</b>
<b>7.5</b>	<b>OPTIONS.....</b>	<b>198</b>

# 7.1 Section Safety

### DANGER

#### Electrical Shock Hazard

**Do not connect or disconnect wiring while the power is on.**

Failure to comply will result in death or serious injury.

Disconnect all power to the drive, wait at least one minute after all indicators are off, measure the DC bus voltage to confirm safe level, and check for unsafe voltages before servicing to prevent electric shock. The internal capacitor remains charged even after the power supply is turned off. The charge indicator LED will extinguish when the DC bus voltage is below 50 Vdc.

### WARNING

#### Electrical Shock Hazard

**Do not operate equipment with covers removed.**

Failure to comply could result in death or serious injury.

The diagrams in this section may show drives without covers or safety shields to show details. Be sure to reinstall covers or shields before operating the drives and run the drives according to the instructions described in this manual.

**Do not remove covers or touch circuit boards while the power is on.**

Failure to comply could result in death or serious injury.

**Do not touch any terminals before the capacitors have fully discharged.**

Failure to comply could result in death or serious injury.

Before wiring terminals, disconnect all power to the equipment. The internal capacitor remains charged even after the power supply is turned off. The charge indicator LED will extinguish when the DC bus voltage is below 50 Vdc. To prevent electric shock, wait at least one minute after all indicators are off and measure the DC bus voltage level to confirm safe level.

**Do not allow unqualified personnel to perform work on the drive.**

Failure to comply could result in death or serious injury.

Installation, maintenance, inspection and servicing must be performed only by authorized personnel familiar with installation, adjustment and maintenance of AC drives.

 **WARNING**

**Do not perform work on the drive while wearing loose clothing, jewelry or without eye protection.**

Failure to comply could result in death or serious injury.

Remove all metal objects such as watches and rings, secure loose clothing and wear eye protection before beginning work on the drive.

**Always ground the motor-side grounding terminal.**

Improper equipment grounding could result in death or serious injury by contacting the motor case.

**Do not change wiring or remove option unit while power is running through the drive.**

Failure to comply could result in death or serious injury.

Disconnect all power to the drive and check for unsafe voltages before servicing.

**Tighten all terminal screws to the specified tightening torque.**

Loose electrical connections could result in death or serious injury by fire due to overheating of electrical connections.

**NOTICE**

**Observe proper electrostatic discharge procedures (ESD) when handling the drive and circuit boards.**

Failure to comply may result in ESD damage to the drive circuitry.

**Never connect or disconnect the motor from the drive while the drive is outputting voltage.**

Improper equipment sequencing could result in damage to the drive.

# 7.2 Drive Options and Peripheral Devices

The following table of peripheral devices lists the names of the various devices/options available for Yaskawa drives. Contact Yaskawa or your Yaskawa agent to order these peripheral devices.

- **Peripheral Device Selection:** Refer to Yaskawa catalog for selection and part numbers.
- **Peripheral Device Installation:** Refer to option manual for option installation instructions.

**Table 7.1 Available Peripheral Devices**

Option	Model Number	Description
<b>Power Options</b>		
DC Link Choke	UZDA Series	DC link choke to improve power factor
AC Reactor	UZBA Series	AC reactor to improve power factor
Braking Resistor </>	ERF-150WJ Series	3% ED, 150 W braking resistor
Surge Absorber	200 V class: DCR2-□A 400 V class: RFN3AL-504KD	Suppresses surge voltage caused by switching magnetic contactors
Molded Case Circuit Breaker	NF Series	Circuit breaker for short circuit or overload protection <b>Note:</b> Yaskawa recommends installing an MCCB to the power supply side to protect drive wiring and to prevent other damage in the event of component failure. Install an MCCB if permitted by the power system.
Ground Fault Circuit Interrupter (GFCI)	NV, EG, or SG Series	Provides protection against potentially harmful leakage currents <b>Note:</b> Yaskawa recommends installing a GFCI to the power supply side to protect drive wiring and to prevent other damage in the event of component failure. An MCCB can also be used if permitted by the power system.
Magnetic Contactor (Input)	SC Series	Prevents potential damage to the braking resistor and other internal circuitry by ensuring that power to drive is completely shut off when necessary. Install an MCCB when using a braking resistor to prevent the braking resistor from overheating. Wire the MC so that it opens when a fault output terminal is triggered to protect internal components from sudden high levels of input current.
<b>Interface Options</b>		
Remote LED Operator	JVOP-182	Remote operator with LED display and copy function; Cable length max. 3 m
USB/Copy Unit	JVOP-181	Allows the user to copy and verify parameter settings between drives. Can also be used as adapter to connect the drive to a PC USB port. <b>Note:</b> SI-232/JC option is required
RS-232C Serial Communication Interface	SI-232/JC	RS-232/C communications interface to either connect the drive to a PC, to the optional copy unit, or to the external LED operator JVOP-182.

## 7.2 Drive Options and Peripheral Devices

Option	Model Number	Description
Remote Operator Interface	SI-232/J	RS-232/C communications interface for use with either the external LED operator JVOP-182, the optional copy unit, or for connecting to a PC.
Potentiometer Option	AI-V3/J	Potentiometer option for setting the frequency reference directly at the drive
<b>Mechanical Options</b>		
Heatsink External Mounting Attachment	EZZ020568□	Installation kit for mounting the drive with the heatsink outside of the panel (side-by-side mounting possible)
DIN Rail Attachment	EZZ08122□	Installation kit for mounting the drive on a DIN rail
NEMA Type 1 Kit	EZZ020564□	Parts to make the drive conform to NEMA Type 1 enclosure
<b>Others</b>		
Drive Wizard Plus	—	PC tool for drive setup and parameter management The installation files can be obtained at no charge from: US: <a href="http://www.yaskawa.com">http://www.yaskawa.com</a> Other areas: Contact a Yaskawa representative.
<b>Communication Options</b>		
RS-422/485 Serial Communications Interface	SI-485/J	Interface for RS-422/RS-485 communications using the MEMOBUS/Modbus RTU protocol

<I> Contact Yaskawa or your nearest Yaskawa representative for more information.

# 7.3 Connecting Peripheral Devices

Figure 7.1 illustrates connections between the drive, motor, and various peripheral devices. Refer to peripheral device option manual for detailed installation instructions.

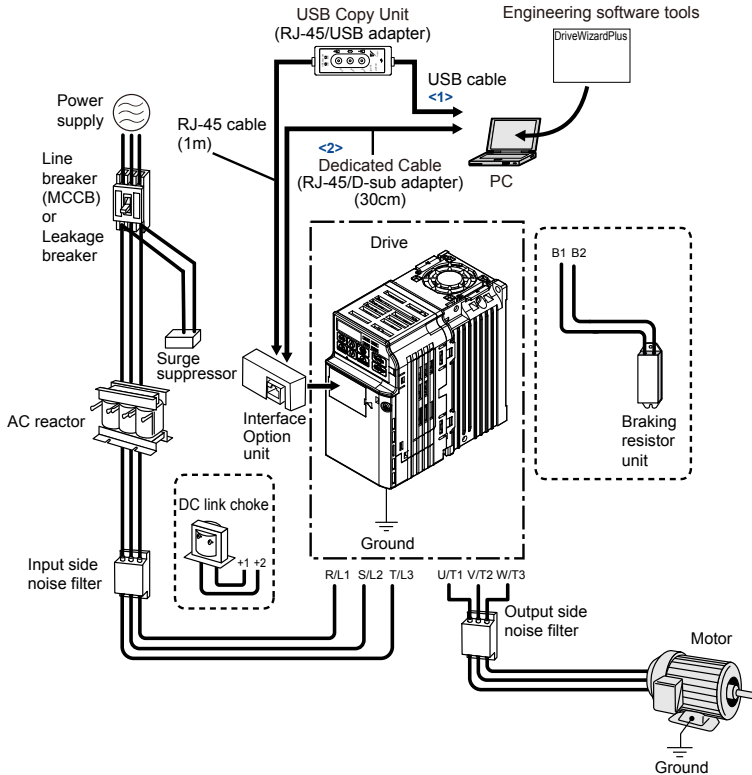


Figure 7.1 Connecting Peripheral Devices

<1> **NOTICE:** Do not connect the LAN port on a PC and the comm. port of the RS-232/C Interface Option Unit (SI-232/J and SI-232/JC). Failure to comply may damage the option unit and the PC. Use the USB Copy Unit with an RJ-45 cable and USB cable as shown in Figure 7.1 to connect the drive to a PC.

<2> The Interface Option Unit can be directly connected to a PC with a D-sub 9-pin connector. Use a cable designed for PC use (Yaskawa part number WV103).

**Note:** If the drive is set to trigger an output terminal when performing a fault restart ( $L5-02 = 1$ ), the power supply will be shut off during fault restart as the drive outputs a fault signal. Keep this in mind when designing a wiring sequence to interrupt the power to the drive. The default setting for the drive is to not trigger an output terminal that indicates a fault restart is being performed ( $L5-02 = 0$ ).

# 7.4 Installing Peripheral Devices

This section describes the proper steps and precautions to take when installing or connecting various peripheral devices to the drive.

Refer to peripheral device manual for detailed installation instructions.

**NOTICE:** Use a class 2 power supply (UL standard) when connecting to the control terminals. Improper application of peripheral devices could result in drive performance degradation due to improper power supply.

## ◆ Installing a Molded Case Circuit Breaker (MCCB) and Earth Leakage Circuit Breaker (ELCB)

Install an MCCB or ELCB for line protection between the power supply and the main circuit power supply input terminals R/L1, S/L2 and T/L3. This protects the main circuit and devices wired to the main circuit while also providing overload protection.

Consider the following when selecting and installing an MCCB or ELCB:

- The rated current of the MCCB or ELCB should be 1.5 to 2 times the rated output current of the drive. Use an MCCB or ELCB with operation characteristics that do not trip the MCCB or ELCB faster than the drive overload protection (shuts off the drive after 1 minute of operation at 150% of the drive rated current).
- If several drives are connected to one MCCB or an ELCB that is shared with other equipment, use a sequence that shuts the power OFF when errors are output by using magnetic contactor (MC) as shown in the following figure.

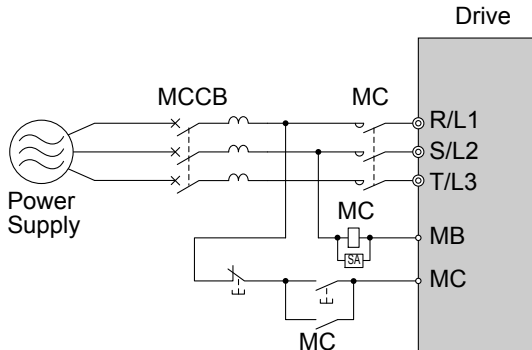


Figure 7.2 Connecting an MCCB



**WARNING!** *Electrical Shock Hazard. Disconnect the MCCB (or ELCB) and MC before wiring terminals. Failure to comply may result in serious injury or death.*

### ◆ Application Precautions when Installing a GFCI

Drive outputs generate high-frequency leakage current as a result of high-speed switching. Install a GFCI on the input side of the drive to switch off potentially harmful leakage current.

Factors in determining leakage current:

- Size of the AC drive
- AC drive carrier frequency
- Motor cable type and length
- EMI/RFI filter

If the GFCI trips spuriously, consider changing these items or use a GFCI with a higher trip level.

**Note:** Choose a GFCI designed specifically for an AC drive. The operation time should be at least 0.1 s with sensitivity amperage of at least 200 mA per drive. The output waveform of the drive may cause an increase in leakage current. This may in turn cause the leakage breaker to malfunction. Increase the sensitivity amperage or lower the carrier frequency to correct the problem.

### ◆ Installing a Magnetic Contactor

#### ■ Disconnecting the Power Supply

The drive should be shut off in the case of a fault in external equipment such as braking resistors through use of a Magnetic Contactor (MC).

**NOTICE:** *Do not connect electromagnetic switches or MCs to the output motor circuits without proper sequencing. Improper sequencing of output motor circuits may cause damage to the drive.*

**NOTICE:** *Install an MC on the input side of the drive when the drive should not automatically restart after power loss. To get the full performance life out of the electrolytic capacitors and circuit relays, refrain from switching the MC more than once every 30 minutes. Frequent use can damage the drive. Use the drive to stop and start the motor.*

- Note:**
1. Install an MC to the drive output to prevent the drive from restarting automatically when the power is restored after momentary power loss.
  2. Set up a delay for the MC so that it does not open prematurely for the drive to continue operating through momentary power loss.

## 7.4 Installing Peripheral Devices

### ■ Protecting the Braking Resistor or Braking Resistor Unit

Use an MC on the input side of the drive to protect a braking resistor or braking resistor unit from overheat or fire.

**WARNING! Fire Hazard.** When using a braking unit, use a thermal relay on the braking resistors and configure a fault contact output for the braking resistor unit to disconnect drive main power via an input contactor. Inadequate braking circuit protection could result in death or serious injury by fire from overheating resistors.

### ◆ Connecting an AC Reactor or DC Link Choke

AC reactors and DC link chokes suppress surges in current and improve the power factor on the input side of the drive.

Use an AC reactor, DC link choke, or both:

- To suppress harmonic current or improve the power factor of the power supply.
- When using a phase advancing capacitor switch.
- With a large capacity power supply transformer (over 600 kVA).

**Note:** Use an AC reactor or DC link choke when also connecting a thyristor converter (such as a DC drive) to the same power supply system, regardless of the conditions of the power supply.

### ■ Connecting an AC Reactor

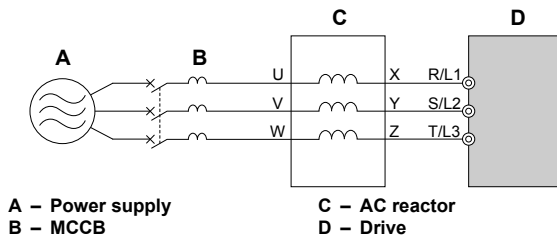


Figure 7.3 Connecting an AC Reactor

### ■ Connecting a DC Link Choke

Ensure the jumper between terminals +1 and +2 (terminals are jumpered for shipment) is removed when connecting a DC link choke. The jumper must be installed if no DC link choke is used. *Refer to Connecting a DC Link Choke on page 187* for an example of DC link choke wiring.

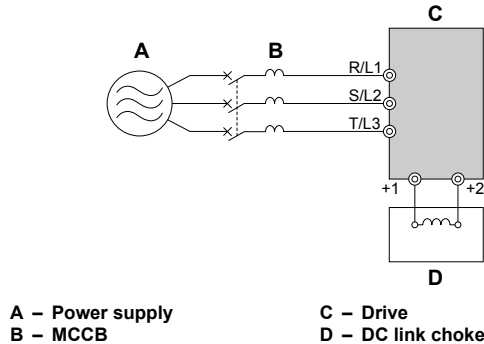


Figure 7.4 Connecting a DC Link Choke

### ◆ Connecting a Surge Suppressor

A surge suppressor suppresses transient voltages generated from switching an inductive load near the drive. Inductive loads include magnetic contactors, relays, valves, solenoids and brakes. Always use a surge suppressor or diode when operating with an inductive load.

**Note:** Never connect a surge suppressor to the drive output.

### ◆ Connecting a Noise Filter

#### ■ Input-Side Noise Filter

Drive outputs generate noise as a result of high-speed switching. This noise flows from inside the drive back toward the power supply, possibly affecting other equipment. Installing a noise filter to the input side of the drive can reduce the amount of noise flowing back into the power supply. This also prevents noise from entering the drive from the power supply.

- Use a noise filter specifically designed for AC drives.
- Install the noise filter as close as possible to the drive.

## 7.4 Installing Peripheral Devices

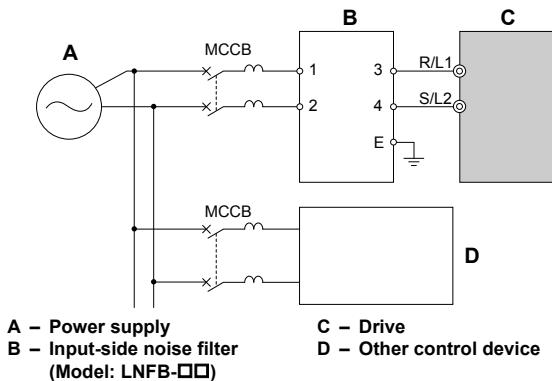


Figure 7.5 Input-Side Noise Filter (Single-Phase 200 V)

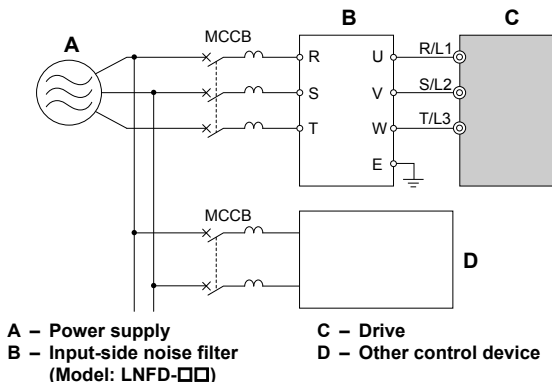


Figure 7.6 Input-Side Noise Filter (Three-Phase 200/400 V)

*Refer to EMC Filter Installation on page 249* for details about EMC filter selection and installation in order to make the drive compliant with European standards EN 61800-3:2004/A1:2012 and the EMC guidelines.

### ■ Output-Side Noise Filter

A noise filter on the output side of the drive reduces inductive noise and radiated noise. *Figure 7.7* illustrates an example of output-side noise filter wiring.

## 7.4 Installing Peripheral Devices

**NOTICE:** Do not connect phase-advancing capacitors or LC/RC noise filters to the output circuits. Improper application of noise filters could result in damage to the drive.

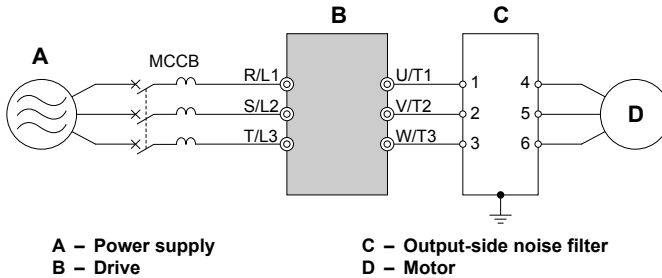


Figure 7.7 Output-Side Noise Filter

- **Radiated Noise:** Electromagnetic waves radiated from the drive and cables create noise throughout the radio bandwidth that can affect devices.
- **Induced Noise:** Noise generated by electromagnetic induction can affect the signal line and may cause the controller to malfunction.

### Preventing Induced Noise

Use a noise filter on the output side or use shielded cables. Lay the cables at least 30 cm away from the signal line to prevent induced noise.

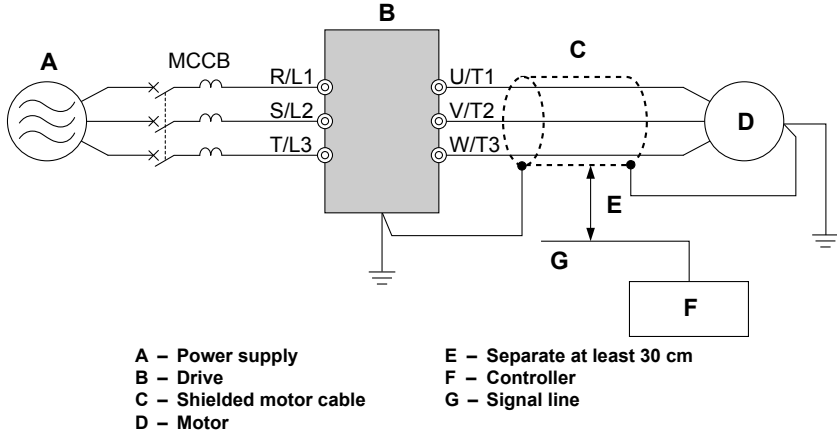


Figure 7.8 Preventing Induced Noise

## 7.4 Installing Peripheral Devices

### Reducing Radiated/Radio Frequency Noise

The drive, input lines, and output lines generate radio frequency noise. Use noise filters on input and output sides and install the drive in a metal enclosure panel to reduce radio frequency noise.

**Note:** The cable running between the drive and motor should be as short as possible.

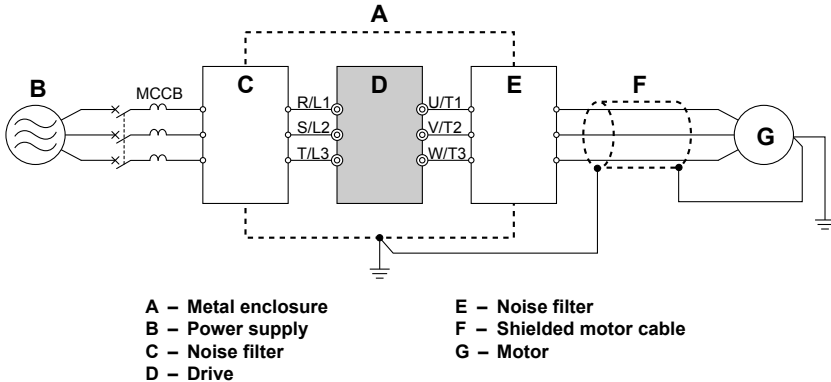


Figure 7.9 Reducing Radio Frequency Noise

### ◆ EMC Filter Installation

This drive is tested according to European standards IEC/EN 61800-5-1 and it complies with the EMC guidelines. [Refer to EMC Filter Installation on page 249](#) for details about EMC filter selection and installation.

### ◆ Zero-Phase Reactor

A zero-phase reactor can be used to reduce the noise on the input and output sides of the drive.

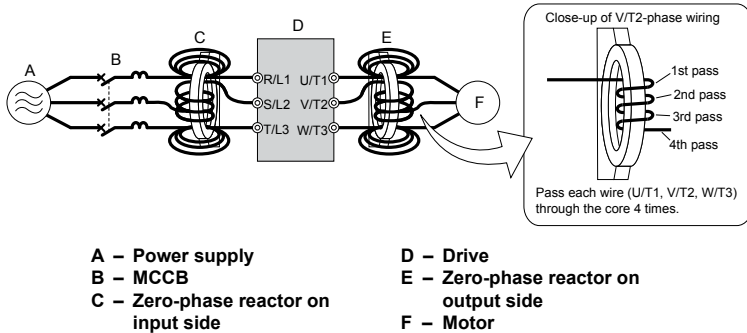


Figure 7.10 Zero-Phase Reactor

### ◆ Installing Fuses on the Input Side

Always install input fuses to the input side of the as a protective measure against damage caused by a short circuit.

*Refer to Factory Recommended Drive Branch Circuit Protection on page 258* for details on input fuse selection.

### ◆ Attachment for External Heatsink

An external attachment can be used to project the heatsink outside of an enclosure to ensure that there is sufficient air circulation around the heatsink. This installation method still requires a certain amount of airflow over the drive case. *Refer to Output Current Derating Due to Ambient Temperature on page 211* if derating is required. Contact a Yaskawa sales representative for more information.

### ◆ Noise Filter Installation

This drive has undergone testing in conformance with IEC/EN 61800-5-1 and is in compliance with low voltage directives. *Refer to EMC Guidelines Compliance on page 248* for information on selecting a noise filter.

### ◆ Installing a Motor Thermal Overload (oL) Relay on the Drive Output

Motor thermal overload relays protect the motor by disconnecting power lines to the motor due to a motor overload condition.

Install a motor thermal overload relay between the drive and motor:

## 7.4 Installing Peripheral Devices

---

- When operating multiple motors on a single AC drive.
- When using a power line bypass to operate the motor directly from the power line.

It is not necessary to install a motor thermal overload relay when operating a single motor from a single AC drive. The AC drive has UL recognized electronic motor overload protection built into the drive software.

**Note:** Disable the motor protection function (L1-0 1 = “0”) when using an external motor thermal overload relay. The relay should shut off main power on the input side of the main circuit when triggered.

### ■ General Precautions when Using Thermal Overload Relays

The following application precautions should be considered when using motor thermal overload relays on the output of AC drives in order to prevent nuisance trips or overheat of the motor at low speeds:

- Low speed motor operation
- Use of multiple motors on a single AC drive
- Motor cable length
- Nuisance tripping resulting from high AC drive carrier frequency

#### Low Speed Operation and Motor Thermal oL Relays

Generally, thermal relays are applied on general-purpose motors. When general-purpose motors are driven by AC drives, the motor current is approximately 5 to 10% greater than if driven by the commercial power supply. In addition, the cooling capacity of a motor with a shaft-driven fan decreases when operating at low speeds. Even if the load current is within the motor rated value, motor overheating may occur. A thermal relay cannot effectively protect the motor due to the reduction of cooling at low speeds. For this reason, apply the UL recognized electronic thermal overload protection function built into the drive whenever possible.

**UL recognized electronic thermal overload function of the drive:** Speed-dependent heat characteristics are simulated using data from standard motors and force-ventilated motors. The motor is protected from overload using this function.

#### Using One Drive with Multiple Motors

Turn off the electronic thermal overload function. Please refer to the appropriate product instruction manual to determine which parameter disables this function.

The UL recognized electronic thermal overload function of the drive cannot be applied when using multiple motors on one drive.

#### Long Motor Cables

When long motor cables and high carrier frequency are used, nuisance tripping of the thermal relay may occur due to increased leakage current. Therefore, reduce the carrier frequency or increase the tripping level of the thermal overload relay.



### Nuisance Tripping Resulting from High AC Drive Carrier Frequency

Current waveforms generated by high carrier frequency PWM drives tend to create additional temperature rise in overload relays. Therefore, it may be necessary to increase the trip level setting when encountering nuisance tripping of the relay.

**WARNING! Fire Hazard.** Confirm an actual motor overload condition is not present prior to increasing the thermal oL trip setting. Check local electrical codes before making adjustments to motor thermal overload settings.

### ◆ NEMA Type 1 Kit

**WARNING! Fire Hazard.** Provide sufficient cooling when installing the drive inside an enclosed panel or cabinet. Failure to comply could result in overheating and fire. When multiple drives are placed inside the same enclosure panel, install proper cooling to ensure air entering the enclosure does not exceed 40 °C.

The optional NEMA Type 1 kit can be installed to raise the enclosure protection level of an IP20/Open-Chassis drive to NEMA Type 1. Drives with a NEMA Type 1 kit cannot be installed using side-by-side mounting unless the top cover is removed. The drive does not retain NEMA Type 1 integrity with the top cover removed. *Refer to Installation Orientation and Spacing on page 30* for installation instructions.

### ■ Installation Environment

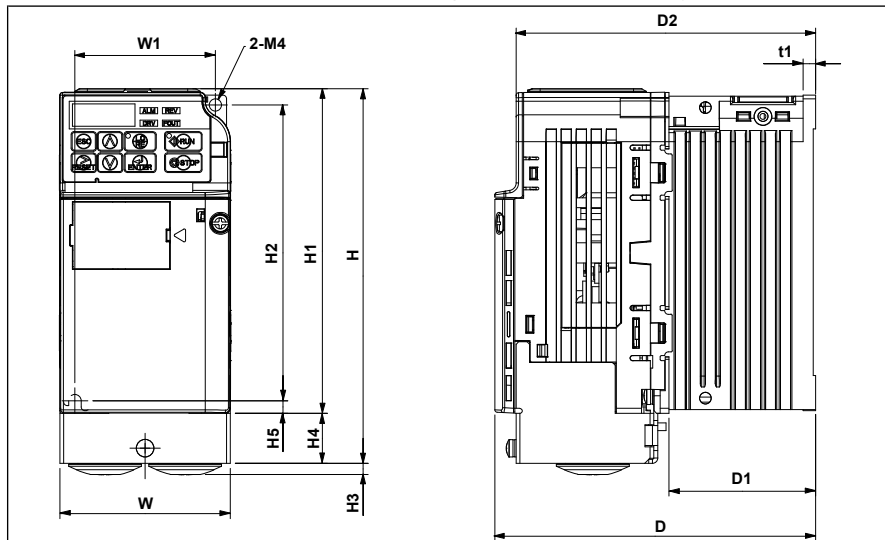
Table 7.2 Installation Environment

Environment	Conditions
Ambient Temperature	-10 °C to +40 °C (NEMA Type 1/wall-mounted enclosure) Drive reliability improves in environments without wide temperature fluctuations. When using an enclosure panel, install a cooling fan or air conditioner in the area to ensure that the air temperature inside the enclosure does not exceed the specified levels. Do not allow ice to develop on the drive.
<i>Refer to Installation Environment on page 29</i> for all other installation environment specifications.	

## 7.4 Installing Peripheral Devices

### ■ Exterior and Mounting Dimensions for NEMA Type 1 Kit

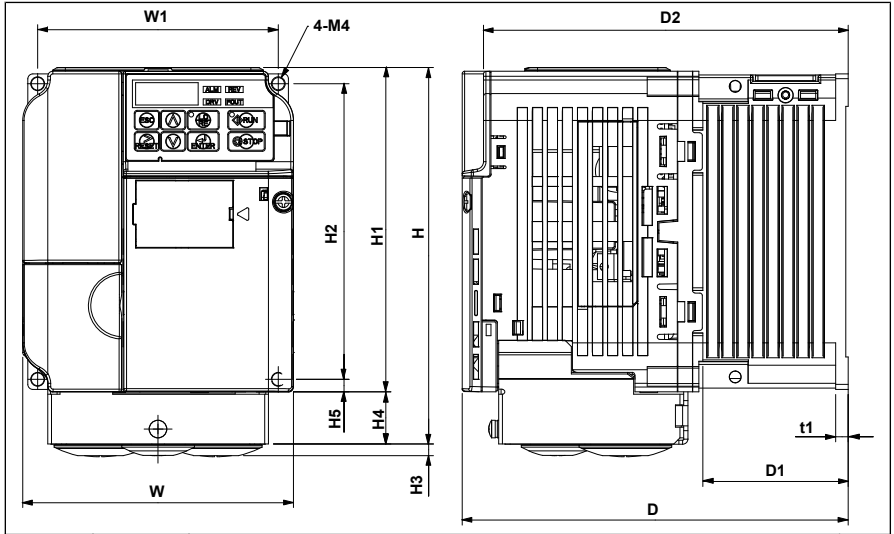
Table 7.3 IP20/Open-Chassis Design Fitted with the NEMA Type 1 Kit



Drive Model	NEMA Type 1 Kit Model EZZ	Dimensions (in)													Wt. (lb)
		W	H	D	W1	H1	H2	H3	H4	H5	H6	D1	D2	t1	
<b>Single-Phase 200 V Class</b>															
BA0001B	020564A	2.7	5.8	3.0	2.2	5.0	4.6	0.2	0.8	0.2	0.06	0.3	2.7	0.1	1.8
BA0002B	020564A	2.7	5.8	3.0	2.2	5.0	4.6	0.2	0.8	0.2	0.06	0.3	2.7	0.1	1.8
BA0003B	020564B	2.7	5.8	4.6	2.2	5.0	4.6	0.2	0.8	0.2	0.06	1.5	4.3	0.2	2.7
<b>Three-Phase 200 V Class</b>															
2A0001B	020564A	2.7	5.8	3.0	2.2	5.0	4.6	0.2	0.8	0.2	0.06	0.3	2.7	0.1	1.8
2A0002B	020564A	2.7	5.8	3.0	2.2	5.0	4.6	0.2	0.8	0.2	0.06	0.3	2.7	0.1	1.8
2A0004B	020564A	2.7	5.8	4.3	2.2	5.0	4.6	0.2	0.8	0.2	0.06	1.5	3.9	0.1	2.4
2A0006B	020564A	2.7	5.8	5.0	2.2	5.0	4.6	0.2	0.8	0.2	0.06	2.3	4.7	0.1	2.9

## 7.4 Installing Peripheral Devices

Table 7.4 IP20/Open-Chassis Design Fitted with the NEMA Type 1 Kit



Drive Model	NEMA Type 1 Kit Model EZZ	Dimensions (in)														Wt. (lb)
		W	H	D	W1	H1	H2	H3	H4	H5	H6	D1	D2	t1		
<b>Single-Phase 200 V Class</b>																
BA0006B	020564C	4.3	5.9	5.4	3.8	5.0	0.18	0.2	0.8	0.2	0.06	2.3	5.1	0.2	4.2	
BA0010B	020564D	4.3	5.9	6.1	3.8	5.0	0.18	0.2	0.8	0.2	0.06	2.3	5.7	0.2	4.4	
<b>Three-Phase 200 V Class</b>																
2A0010B	020564G	4.3	5.9	5.1	3.8	5.0	0.18	0.2	0.8	0.2	0.06	2.3	4.7	0.2	4.2	
2A0012B	020564C	4.3	5.9	5.4	3.8	5.0	0.18	0.2	0.8	0.2	0.06	2.3	5.1	0.2	4.2	
2A0020B	020564H	4.3	5.9	5.6	5.0	5.0	0.18	0.2	0.8	0.2	0.2	2.6	5.3	0.2	5.7	
<b>Three-Phase 400 V Class</b>																
4A0001B	020564G	4.3	5.9	3.2	3.8	5.0	0.18	0.2	0.8	0.2	0.06	0.4	2.9	0.2	2.6	
4A0002B	020564G	4.3	5.9	3.9	3.8	5.0	0.18	0.2	0.8	0.2	0.06	1.1	3.6	0.2	3.1	
4A0004B	020564C	4.3	5.9	5.4	3.8	5.0	0.18	0.2	0.8	0.2	0.06	2.3	5.1	0.2	4.2	
4A0005B	020564J	4.3	5.9	6.1	3.8	5.0	0.18	0.2	0.8	0.2	0.06	2.3	5.7	0.2	4.2	
4A0007B	020564J	4.3	5.9	6.1	3.8	5.0	0.18	0.2	0.8	0.2	0.06	2.3	5.7	0.2	4.2	
4A0009B	020564J	4.3	5.9	6.1	3.8	5.0	0.18	0.2	0.8	0.2	0.06	2.3	5.7	0.2	4.2	
4A0011B	020564H	4.3	5.9	5.6	5.0	5.0	0.18	0.2	0.8	0.2	0.2	2.6	5.3	0.2	5.7	

## 7.4 Installing Peripheral Devices

---

### ■ Removing the Protective Covers on a NEMA Type 1 Design (Using the NEMA Type 1 Kit Option for the NEMA Type 1 Rating)

1. Loosen the screw on the front cover to remove the front cover.

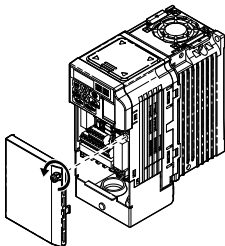


Figure 7.11 Remove the Front Cover

2. Loosen the screw on the terminal cover ([Figure 7.12, B](#)) to remove the terminal cover and expose the conduit bracket ([Figure 7.12, A](#)).

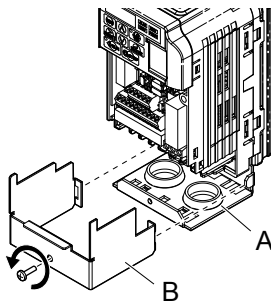


Figure 7.12 Remove the Terminal Cover

3. Loosen two screws attaching the conduit bracket ([Figure 7.13, A](#)) to remove.

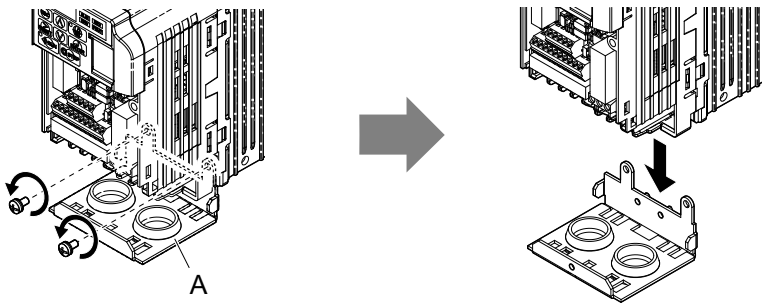
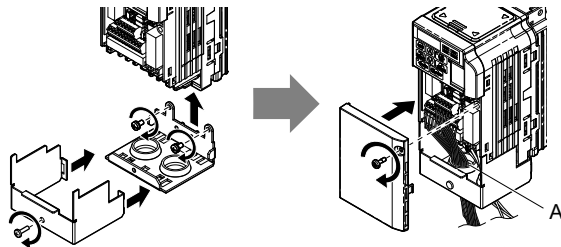


Figure 7.13 Remove the Conduit Bracket

### ■ Reattaching the Protective Covers

Pass power wiring and control signal wiring through the exit holes on the bottom of the conduit bracket of the drive. Place power wiring and control signal wiring in separate conduits. Properly connect all wiring after installing the drive and connecting other devices. Reattach all protective covers when wiring is complete.



A – Pass power wiring and control signal wiring through different exit holes at the bottom of the drive.

Figure 7.14 Reattach the Protective Covers and Conduit Bracket

# 7.5 Options

**Table 7.5** and **Table 7.6** give detailed information about the available options that allow Yaskawa drives to connect to communication networks. A host controller can control and monitor the drive, read and change parameters by using a communication option. Contact Yaskawa or your Yaskawa agent to order options.

- **Option Selection:** Refer to Yaskawa catalog for more details on option card selection and part numbers.
- **Option Installation:** Refer to option unit manual for option unit installation instructions.

## ◆ Interface Options

**Table 7.5 Interface Option Units**

Option	Model	Function
RS-232C Interface	SI-232/J	Allows the user to connect an extension cable for remote operation and for use with Drive Wizard Plus.
RS-232C Interface (Removable)	SI-232/JC	Allows the user to take advantage of the USB Copy Unit option and the Remote LED Operator option.
RS-422/RS-485 Interface for MEMOBUS/Modbus Communication	SI-485/J	Allows the drive to connect to a network using MEMOBUS/Modbus RTU protocol. Option includes a communication cable connector.
Potentiometer	AI-V3/J	Allows for easier speed control.

## ◆ Other Options

**Table 7.6 Other Options**

Option	Model	Function
Remote LED Operator	JVOP-182	Allows for remote operation when using the optional LED operator. This option is used in combination with the LED extension cable and the RS-232C interface. Option includes a Copy function for saving drive settings.
USB Copy Unit	JVOP-181	Saves and transfers parameter settings and connects to a PC for operation with Drive Wizard Plus. This option is used in combination with the RS-232C interface.

# Appendix: A

## Specifications

<b>A.1</b>	<b>HEAVY DUTY AND NORMAL DUTY RATINGS</b>	<b>200</b>
<b>A.2</b>	<b>SINGLE/THREE-PHASE 200 V CLASS DRIVES.....</b>	<b>201</b>
<b>A.3</b>	<b>THREE-PHASE 400 V CLASS DRIVES.....</b>	<b>203</b>
<b>A.4</b>	<b>DRIVE SPECIFICATIONS.....</b>	<b>205</b>
<b>A.5</b>	<b>DRIVE WATT LOSS DATA.....</b>	<b>209</b>
<b>A.6</b>	<b>DRIVE DERATING DATA.....</b>	<b>211</b>

# A.1 Heavy Duty and Normal Duty Ratings

The capacity of the drive is based on two types of load characteristics: Heavy Duty (HD) and Normal Duty (ND).

*Refer to [Selecting the Appropriate Load Rating on page 200](#) for the differences between HD and ND. Specifications for capacity ratings are listed on the following pages.*

**Table A.1 Selecting the Appropriate Load Rating**

Setting Parameter C6-01	Rated Output Current	Overload Tolerance	Default Carrier Frequency
0: Heavy Duty	HD Rating varies by model </>	150% rated output current for 60 s	8/10 kHz varies by model
1: Normal Duty (default)	ND Rating varies by model </>	120% rated output current for 60 s varies by model	2 kHz, Swing PWM

<1> The following pages list information on rating changes based on drive model.



- **HD and ND:** HD refers to applications requiring constant torque output, while ND refers to applications with variable torque needs. The drive allows the user to select HD or ND torque depending on the application. Fans, pumps, and blowers should use ND (C6-01 = 1), and other applications generally use HD (C6-01 = 0).
- **Swing PWM:** Swing PWM equivalent to a 2 kHz audible noise. This function turns the motor noise into a less obtrusive white noise.

**Note:** Differences between HD ratings and ND ratings for the drive include rated input and output current, overload capacity, carrier frequency, and current limit. The default setting is for ND (C6-01 = 1).



## A.2 Single/Three-Phase 200 V Class Drives

Table A.2 Power Ratings

Item			Specification							
Three-Phase Drive Model			2A0001	2A0002	2A0004	2A0006	2A0010	2A0012	2A0020	
Single-Phase Drive Model <1>			BA0001	BA0002	BA0003	BA0006	BA0010	-	-	
Maximum Motor Size Allowed (HP) <2>	ND Rating		0.125 & 0.25	0.25	0.5 & 0.75	1.0 & 1.5	2.0 & 3.0	3.0	5.0	
	HD Rating		0.125	0.25	0.5	0.75 & 1	2.0	3.0	5.0	
Input	Input Current (A) <3>	Three-Phase	ND Rating	1.1	1.9	3.9	7.3	10.8	13.9	24.0
		Three-Phase	HD Rating	0.7	1.5	2.9	5.8	7.5	11.0	18.9
	Single-Phase	ND Rating	2.0	3.6	7.3	13.8	20.2	-	-	
		HD Rating	1.4	2.8	5.5	11.0	14.1	-	-	
Output	Rated Output Capacity (kVA) <4>	ND Rating	0.5	0.7	1.3	2.3	3.7	4.6	7.5	
		HD Rating	0.3	0.6	1.1	1.9	3.0	4.2	6.7	
	Output Current (A) <3>	ND Rating	1.2	1.9	3.5 (3.3)	6.0	9.6	12.0	19.6	
		HD Rating	0.8 <6>	1.6 <6>	3.0 <6>	5.0 <6>	8.0 <7>	11.0 <7>	17.5 <7>	
	Overload Tolerance		ND Rating: 120% of rated output current for 1 minute HD Rating: 150% of rated output current for 1 minute (Derating may be required for applications that start and stop frequently)							
	Carrier Frequency		2 kHz (user-set, 2 to 15 kHz)							
	Max Output Voltage (V)		Three-phase power: 200 to 240 V Single-phase power: 200 to 240 V (both proportional to input voltage)							
	Max Output Frequency (Hz)		400 Hz (user-adjustable)							
	Power Supply	Rated Voltage Rated Frequency		Three-phase power: 200 to 240 V 50/60 Hz Single-phase power: 200 to 240 V 50/60 Hz DC power supply: 270 to 340 V <8>						
		Allowable Voltage Fluctuation		-15 to 10%						
Allowable Frequency Fluctuation		±5%								
Harmonic Corrective Actions	DC Link Choke		Optional							

Specifications

**A**

- <1> Drives with a single-phase power supply input will output three-phase power and cannot run a single-phase motor.
- <2> Horsepower rating is based on 230 V Induction-Type Squirrel Cage NEMA B 4-Pole Motors as represented in NEC Table 430.250 Full-Load Current, Three-Phase Alternating-Current Motors.
- <3> Input current rating varies depending on the power supply transformer, input reactor, wiring connections, and power supply impedance.

## A.2 Single/Three-Phase 200 V Class Drives

---

- <4> Rated motor capacity is calculated with a rated output voltage of 220 V.
- <5> Carrier frequency is set to 2 kHz (Swing PWM). Current derating is required to raise the carrier frequency.
- <6> Carrier frequency is set to 10 kHz. Current derating is required to raise the carrier frequency.
- <7> Carrier frequency is set to 8 kHz. Current derating is required to raise the carrier frequency.
- <8> DC is not available for UL standards.

**Note:** Differences between Heavy Duty (HD) ratings and Normal Duty (ND) ratings for the drive include rated input and output current, overload capacity, carrier frequency and current limit. Set parameter C6-01 to “0” for HD or “1” for ND (default).

## A.3 Three-Phase 400 V Class Drives

Table A.3 Power Ratings

Item		Specification							
Three-Phase Drive Model		4A0001	4A0002	4A0004	4A0005	4A0007	4A0009	4A0011	
Maximum Applicable Motor Capacity (HP) <1>	ND Rating	0.5	0.75 & 1	2	3	4	5	7.5	
	HD Rating	0.5	0.75	1 & 2	3	3	3	5	
Input	Input Current (A) <2>	ND Rating	1.2	2.1	4.3	5.9	8.1	9.4	14.0
		HD Rating	1.2	1.8	3.2	4.4	6.0	8.2	10.4
Output	Output Current (kVA) <3>	ND Rating <4>	0.9	1.6	3.1	4.1	5.3	6.7	8.5
		HD Rating <5>	0.9	1.4	2.6	3.7	4.2	5.5	7.0
	Output Current (A)	ND Rating <4>	1.2	2.1	4.1	5.4	6.9	8.8	11.1
		HD Rating <5>	1.2	1.8	3.4	4.8	5.5	7.2	9.2
	Overload Tolerance		ND Rating: 120% of rated output current for 60 s HD Rating: 150% of rated output current for 60 s (Derating may be required for applications that start and stop frequently)						
	Carrier Frequency		2 kHz (user-adjustable from 2 to 15 kHz)						
	Maximum Output Voltage (V)		Three-phase power: 380 to 480 V (proportional to input voltage)						
	Maximum Output Frequency (Hz)		400 Hz (user-adjustable)						
Power Supply	Rated Voltage Rated Frequency		Three-phase power: 380 to 480 V 50/60 Hz DC power supply: 510 to 680 V <6>						
	Allowable Voltage Fluctuation		-15 to 10%						
	Allowable Frequency Fluctuation		±5%						
Harmonic Corrective Actions		DC Link Choke		Optional					

<1> Horsepower rating is based on 460 V Induction-Type Squirrel Cage NEMA B 4-Pole Motors as represented in NEC Table 430.250 Full-Load Current, Three-Phase Alternating-Current Motors.

<2> Input current rating varies depending on the power supply transformer, input reactor, wiring conditions, and power supply impedance.

<3> Rated motor capacity is calculated with a rated output voltage of 440 V.

<4> Carrier frequency is set to 2 kHz (Swing PWM). Current derating is required to raise the carrier frequency.

<5> Carrier frequency is set to 8 kHz. Current derating is required to raise the carrier frequency.

## A.3 Three-Phase 400 V Class Drives

---

<6> DC is not available for UL standards.

**Note:** Differences between Heavy Duty (HD) ratings and Normal Duty (ND) ratings for the drive include rated input and output current, overload capacity, carrier frequency and current limit. Set parameter C6-01 to “0” for HD or “1” for ND (default).

# A.4 Drive Specifications

**Note:** For optimum performance life of the drive, install the drive in an environment that meets the environmental conditions.

Item		Specification
<b>Control Characteristics</b>	<b>Control Method</b>	V/f Control
	<b>Frequency Control Range</b>	0.01 to 400 Hz
	<b>Frequency Accuracy</b>	Digital input: within $\pm 0.01\%$ of the max output frequency (-10 to +50 °C) Analog input: within $\pm 0.5\%$ of the max output frequency (25 °C $\pm 10$ °C)
	<b>Frequency Setting Resolution</b>	Digital inputs: 0.01 Hz Analog inputs: 1/1000 of maximum output frequency
	<b>Output Frequency Calculation Resolution</b>	$1/2^{20}$ x Maximum output frequency (E1-04)
	<b>Frequency Setting Signal</b>	Main frequency reference: 0 to +10 Vdc (20 k $\Omega$ ), 4 to 20 mA (250 $\Omega$ ), 0 to 20 mA (250 $\Omega$ )
	<b>Starting Torque</b>	150%/3 Hz
	<b>Speed Control Range</b>	1: 20~40
	<b>Accel/Decel Time</b>	0.00 to 6000.0 s (allows four separate settings for accel and decel)
	<b>Braking Torque</b>	Instantaneous Average Decel Torque $\langle \triangleright \rangle$ : 0.1/0.2 kW: over 150%, 0.4/0.75 kW: over 100%, 1.5 kW: over 50%, 2.2 kW and above: over 20% Continuous Regen Torque: 20%, 125% with a Braking Resistor Unit $\langle \triangleright \rangle$ : (10% ED) 10 s with an internal braking resistor.
	<b>V/f Characteristics</b>	User-set, programmable.
	<b>Functions</b>	<ul style="list-style-type: none"> <li>• Momentary Power Loss Ride-Thru</li> <li>• Speed Search</li> <li>• Multi-Step Speed (9 steps max)</li> <li>• Accel/Decel Time Switch</li> <li>• S-Curve Accel/Decel</li> <li>• 2-Wire/3-Wire Sequence</li> <li>• Cooling Fan ON/OFF</li> <li>• Slip Compensation</li> <li>• Torque Compensation</li> <li>• Jump Frequencies (reference dead band)</li> <li>• Frequency Reference Upper/Lower Limit</li> <li>• DC Injection Braking (start and stop)</li> <li>• Overexcitation Braking</li> <li>• Fault Reset</li> </ul>

## A.4 Drive Specifications

	Item	Specification
<b>Protection Functions</b>	<b>Motor Protection</b>	Motor overheat protection via output current sensor
	<b>Overcurrent Protection</b>	Drives stops when output exceeds 200% of the rated current (Heavy Duty)
	<b>Overload Protection</b>	A stop command will be entered after operating at 150% for 60 s (Heavy Duty) <3>
	<b>Overvoltage Specification</b>	200 V class: Stops when DC bus voltage exceeds approximately 410 V 400 V class: Stops when DC bus voltage exceeds approximately 820 V
	<b>Low Voltage Protection</b>	Drive stops when DC bus voltage falls below the levels indicated: 190 V (3-phase 200 V), 160 V (single-phase 200 V), 380 V (3-phase 400 V), 350 V (3-phase 380 V)
	<b>Momentary Power Loss Ride-Thru</b>	Stops after 15 ms
	<b>Heatsink Overheat Protection</b>	Protected by thermistor
	<b>Braking Resistor Overheat Protection</b>	Overheat input signal for braking resistor (Optional ERF-type, 3% ED)
	<b>Stall Prevention</b>	During acceleration and during run: Separate settings for each type of stall prevention determine the current level at which stall prevention is triggered. During deceleration: Select, enable/disable.
	<b>Cooling Fan Failure Protection</b>	Circuit protection (“fan-lock” sensor)
	<b>Ground Fault Protection</b>	Electronic circuit protection <4>
	<b>DC Bus Charge LED</b>	Remains lit until DC bus voltage falls below 50 V

## A.4 Drive Specifications

Item		Specification
Environment	Storage/Installation Area	Indoors
	Ambient Temperature	IP20/NEMA Type 1 enclosure: -10 °C to +40 °C (14 °F to 104 °F) IP20/IP00 Open-Chassis enclosure: -10 °C to +50 °C (14 °F to 122 °F) Finless Type: IP20 enclosure: -10 °C to +50 °C (14 °F to 122 °F)
	Humidity	95% RH or less with no condensation
	Storage Temperature	-20 to +60 °C (-4 to +140 °F) allowed for short-term transport of the product
	Altitude	Up to 1000 meters without derating; up to 3000 meters with output current and voltage derating.
	Shock, Impact	10 to 20 Hz: 9.8 m/s <sup>2</sup> 20 to 55 Hz: 5.9 m/s <sup>2</sup>
	Surrounding Area	Install the drive in an area free from: <ul style="list-style-type: none"> <li>oil mist and dust</li> <li>metal shavings, oil, water or other foreign materials</li> <li>radioactive materials</li> <li>combustible materials</li> <li>harmful gases and liquids</li> <li>excessive vibration</li> <li>chlorides</li> <li>direct sunlight</li> </ul>
	Orientation	Install the drive vertically to maintain maximum cooling effects
Standards	<ul style="list-style-type: none"> <li>UL508C</li> <li>EN 61800-3:2004/A1:2012, IEC/EN 61800-5-1</li> </ul>	
Protective Enclosure	IP20/Open-Chassis IP20/NEMA Type 1 <5>	
Cooling Method	BA0001 to BA0006: self-cooled BA0010: cooling fan 2A0001 to 2A0004: self-cooled 2A0006 to 2A0020: cooling fan 4A0001 to 4A0004: self-cooled 4A0005 to 4A0011: cooling fan	

- <1> Instantaneous average deceleration torque refers to the torque required to decelerate the motor (uncoupled from the load) from the rated motor speed down to zero in the shortest time.
- <2> Ensure that Stall Prevention Selection during Deceleration is disabled (L3-04 = 0) or set to 3 when using a braking resistor or the Braking Resistor Unit. The default setting for the stall prevention function will interfere with the braking resistor.
- <3> Overload protection may be triggered when operating with 150% of the rated output current if the output frequency is less than 6 Hz.
- <4> Ground protection cannot be provided under the following circumstances when a ground fault is likely in the motor windings during run: Low ground resistance for the motor cable and terminal block; low ground resistance for the motor cable and terminal block; or the drive is powered up from a ground short.

## A.4 Drive Specifications

---

<5> All models have an IP20/Open-Chassis enclosure as standard. Use the NEMA Type 1 Kit option to convert drives to an IP20/NEMA Type 1 enclosure rating.



## A.5 Drive Watt Loss Data

Table A.4 Watt Loss 200 V Class Single-Phase Models

Drive Model	Heavy Duty (Carrier Frequency 8/10 kHz) <1>				Normal Duty (Swing PWM equal 2 kHz)			
	Rated Amps (A)	Heatsink Loss (W)	Interior Unit Loss (W)	Total Loss (W)	Rated Amps (A)	Heatsink Loss (W)	Interior Unit Loss (W)	Total Loss (W)
BA0001	0.8	4.3	7.4	11.7	1.2	5.0	8.5	13.5
BA0002	1.6	7.9	8.9	16.7	1.9	7.6	9.7	17.3
BA0003	3.0	16.1	11.5	27.7	3.3	14.6	14.4	29.1
BA0006	5.0	33.7	16.8	50.5	6.0	30.1	19.4	49.5
BA0010	8.0	54.8	25.9	80.7	9.6	51.7	29.8	81.4

<1> 10 kHz for BA0001 to BA0006

Table A.5 Watt Loss 200 V Class Three-Phase Models

Drive Model	Heavy Duty (Carrier Frequency 8/10 kHz) <1>				Normal Duty (Swing PWM equal 2 kHz)			
	Rated Amps (A)	Heatsink Loss (W)	Interior Unit Loss (W)	Total Loss (W)	Rated Amps (A)	Heatsink Loss (W)	Interior Unit Loss (W)	Total Loss (W)
2A0001	0.8	4.3	7.3	11.6	1.2	5.0	8.0	13.0
2A0002	1.6	7.9	8.8	16.7	1.9	7.6	9.5	17.1
2A0004	3.0	16.2	11.5	27.7	3.5	15.8	13.6	29.4
2A0006	5.0	27.4	15.9	43.3	6.0	27.5	17.2	44.7
2A0010	8.0	54.8	23.8	78.6	9.6	51.7	25.8	77.5
2A0012	11.0	70.7	29.9	100.6	12.0	61.3	30.4	91.7
2A0020	17.5	110.5	43.3	153.8	19.6	98.7	46.3	145.0

<1> 10 kHz for 2A0001 to 2A0006

Table A.6 Watt Loss 400 V Class Three-Phase Models

Drive Model	Heavy Duty (Carrier Frequency 8 kHz)				Normal Duty (Swing PWM equal 2 kHz)			
	Rated Amps (A)	Heatsink Loss (W)	Interior Unit Loss (W)	Total Loss (W)	Rated Amps (A)	Heatsink Loss (W)	Interior Unit Loss (W)	Total Loss (W)
4A0001	1.2	19.2	11.5	30.7	1.2	10.0	9.6	19.6
4A0002	1.8	28.9	14.8	43.7	2.1	18.5	13.9	32.4
4A0004	3.4	42.3	17.9	60.2	4.1	30.5	16.8	47.3
4A0005	4.8	70.7	26.2	96.9	5.4	44.5	21.8	66.3

## A.5 Drive Watt Loss Data

---

Drive Model	Heavy Duty (Carrier Frequency 8 kHz)				Normal Duty (Swing PWM equal 2 kHz)			
	Rated Amps (A)	Heatsink Loss (W)	Interior Unit Loss (W)	Total Loss (W)	Rated Amps (A)	Heatsink Loss (W)	Interior Unit Loss (W)	Total Loss (W)
4A0007	5.5	81.0	30.7	111.7	6.9	58.5	28.4	86.9
4A0009	7.2	84.6	32.9	117.5	8.8	63.7	31.4	95.1
4A0011	9.2	107.2	41.5	148.7	11.1	81.7	46.0	127.7

## A.6 Drive Derating Data

The drive can be operated at above rated temperature, altitude and default carrier frequency by derating the drive capacity.

### ◆ Temperature Derating

As the ambient temperature for the drive is increased above the drive specification the drive should be derated. Additionally parameter L8-35 Installation Method Selection on page 211 should be set according to enclosure type and mounting method as illustrated in [Figure A.1](#).

### ■ Output Current Derating Due to Ambient Temperature

Set L8-12 and L8-35 according to the installation conditions when the ambient temperature is above the drive specification or if drives are side-by-side mounted in a cabinet. The output current is derated as shown in [Figure A.1](#).

No.	Name	Description	Range	Def.
L8-12	Ambient Temperature Setting	Adjust the drive overload (oL2) protection level when the drive is installed in an environment that exceeds its ambient temperature rating.	-10 to 50	30 °C
L8-35	Installation Method Selection	0: IP20/IP00 Drive 1: Side-by-Side Mounting 2: NEMA Type 1 Drive <I> 3: Finless Drive or External Heatsink Installation	0 to 3	0

<I> This selection assumes that the drive is fitted with the NEMA Type 1 Kit option.

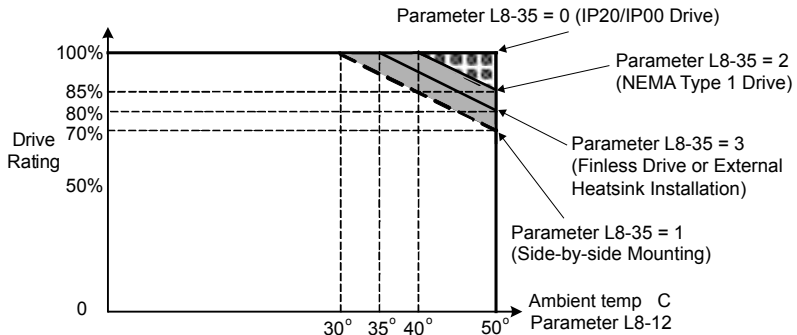


Figure A.1 Ambient Temperature and Installation Method Derating

## A.6 Drive Derating Data

---

### ◆ Altitude Derating

The drive standard ratings are valid for an installation altitude up to 1000 m. If the altitude exceeds 1000 m, both the drive input voltage and the rated output current must be derated for 1% per 100 m. The maximum altitude is 3000 m.

# Appendix: B

## Parameter List

---

This appendix contains a full listing of all parameters and settings available in the drive.

<b>B.1</b>	<b>PARAMETER GROUPS.....</b>	<b>214</b>
<b>B.2</b>	<b>PARAMETER TABLE.....</b>	<b>215</b>
<b>B.3</b>	<b>DEFAULTS BY DRIVE MODEL AND DUTY RATING ND/HD.....</b>	<b>238</b>

# B.1 Parameter Groups

Table B.1 Parameter Groups

Parameter Group	Name	Page
A1	Initialization	<a href="#">215</a>
b1	Operation Mode Selection	<a href="#">216</a>
b2	DC Injection Braking	<a href="#">217</a>
C1	Acceleration/Deceleration Time	<a href="#">217</a>
C2	S-Curve Accel/Decel	<a href="#">217</a>
C3	Motor Slip Compensation	<a href="#">218</a>
C4	Motor Torque Compensation	<a href="#">218</a>
C6	Carrier Frequency	<a href="#">218</a>
d1	Frequency Reference	<a href="#">220</a>
d2	Reference Limits	<a href="#">220</a>
d3	Jump Frequencies	<a href="#">220</a>
d4	Frequency Reference Hold	<a href="#">221</a>
E1	V/f Pattern	<a href="#">222</a>
E2	Motor Setup	<a href="#">222</a>
H1	Digital Inputs	<a href="#">223</a>
H2	Digital Outputs	<a href="#">225</a>
H3	Analog Inputs	<a href="#">226</a>
H4	Analog Outputs	<a href="#">227</a>

Parameter Group	Name	Page
H5	Serial Communications Setup	<a href="#">227</a>
L1	Motor Overload	<a href="#">229</a>
L2	Power Loss Ride-Thru	<a href="#">229</a>
L3	Stall Prevention	<a href="#">229</a>
L4	Reference Detection	<a href="#">230</a>
L5	Fault Restart	<a href="#">231</a>
L6	Overtorque Detection	<a href="#">231</a>
L8	Hardware Protection	<a href="#">231</a>
n1	Hunting Prevention	<a href="#">233</a>
n3	Overexcitation Braking	<a href="#">233</a>
o1	Monitor Display Selection	<a href="#">233</a>
o2	Operator Keypad Functions	<a href="#">233</a>
o3	Copy Function	<a href="#">234</a>
o4	Maintenance Functions	<a href="#">234</a>
U1	Status Monitor	<a href="#">235</a>
U2	Fault History	<a href="#">237</a>
U4	Maintenance Monitor	<a href="#">237</a>

## B.2 Parameter Table

An “O” in the “Mode” column indicates that the parameter is available in the Advanced menu.  
An “S” in the “Mode” column indicates that the parameter is available in the Startup menu.

### ◆ A: Initialization Parameters

The A parameter group creates the operating environment for the drive. This includes the parameter Access Level, and Password.

No.	Name	Description	Range	Def.	Mode	Addr. Hex	Pg.
<b>A1: Initialization Parameters</b> Use A1 parameters to configure the basic environment for drive operation.							
A1-01 <I>	Access Level Selection	Selects which parameters are accessible via the digital operator. 0: Operation only 2: Advanced Access Level	0, 2	2	O	101	117
A1-03	Initialize Parameters	Resets all parameters to factory default settings. (Initializes the drive then returns A1-03 to 0) 0: No Initialization 2220: 2-Wire Initialization 3330: 3-Wire Initialization	0 to 3330	0	O	103	88
A1-04	Password	When the value set into A1-04 does not match the value set into A1-05, parameters A1-01 and A1-03 cannot be changed.	0 to 9999	0	O	104	117
A1-05	Password Setting		0 to 9999	0	O	105	117
This parameter is hidden from view. To access A1-05, first display A1-04. Then press the STOP key while holding down the up arrow key. Parameter A1-05 will appear.							

<I> Parameter can be changed during run.

## B.2 Parameter Table

### ◆ b: Application

Application parameters configure the Run Command Source, DC Injection Braking, and other application-related settings.

No.	Name	Description	Range	Def.	Mode	Addr. Hex	Pg.
<b>b1: Operation Mode Selection</b> Use b1 parameters to configure the operation mode.							
b1-01	Frequency Reference Selection	Selects the frequency reference input source. 0: Digital Operator - Digital preset speed d1-01 to d1-08 1: Terminals - Analog input terminal A1 2: MEMOBUS/Modbus communications (option) 3: Potentiometer (option)	0 to 3	1	S	180	88
b1-02	Run Command Selection	Selects the run command input source. 0: Digital Operator - RUN and STOP keys on the digital operator 1: Digital input terminals 2: MEMOBUS/Modbus communications (option)	0 to 2	1	S	181	90
b1-03	Stopping Method Selection	Selects the stopping method when the run command is removed. 0: Ramp to Stop 1: Coast to Stop	0, 1	0	S	182	92
b1-04	Reverse Operation Selection	Permits or prohibits reverse operation. 0: Reverse enabled. 1: Reverse disabled.	0, 1	0	O	183	–
b1-07	LOCAL/REMOTE Run Selection	Determines the operation when the Run command source is switched from LOCAL to REMOTE or between REMOTE and MEMOBUS/Modbus communication. 0: External Run command has to be cycled at the new source to be activated. 1: External Run command at new source is accepted immediately.	0, 1	0	O	186	–
b1-08	Run Command Selection while in Programming Mode	0: Run command accepted only in the operation menu. 1: Run command accepted in all menus. 2: Prohibit entering Programming Mode during Run	0 to 2	0	O	187	–
b1-14	Phase Order Selection	Sets the phase order for drive output terminals U/T1, V/T2 and W/T3. 0: Standard 1: Switch phase order	0, 1	0	O	1C3	–
b1-17	Run Command at Power Up	Determines the operation when a Run command is active at power up of the drive. 0: Run command not issued, needs to be cycled 1: Run command issued, motor operation start	0, 1	0	O	1C6	–



No.	Name	Description	Range	Def.	Mode	Addr. Hex	Pg.
<b>b2: DC Injection Braking</b> Use b2 parameters to configure DC Injection Braking operation							
b2-02	DC Injection Braking Current	Sets the DC Injection Braking current as a percentage of the drive rated current.	0 to 75	50%	O	18A	–
b2-03	DC Injection Braking Time/DC Excitation Time at Start	Sets DC Injection Braking time at start. Disabled when set to 0.00 seconds.	0.00 to 10.00	0.00 s	O	18B	–
b2-04	DC Injection Braking Time at Stop	Sets DC Injection Braking time at stop. When b1-03 = 0, this parameter sets the amount of DC Injection time applied to the motor at the end of the decel ramp. Disabled when set to 0.00.	0.00 to 10.00	0.50 s	O	18C	–

## ◆ C: Tuning

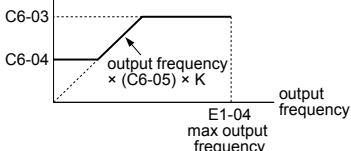
C parameters are used to adjust the acceleration and deceleration times, S-curves, slip and torque compensation functions and carrier frequency selections.

No.	Name	Description	Range	Def.	Mode	Addr. Hex	Pg.
<b>C1: Acceleration and Deceleration Times</b> Use C1 parameters to configure motor acceleration and deceleration.							
C1-01 </>	Acceleration Time 1	Sets the time to accelerate from 0 to maximum frequency.	0.0 to 6000.0	10.0 s	S	200	93
C1-02 </>	Deceleration Time 1	Sets the time to decelerate from maximum frequency to 0.			S	201	93
C1-03 </>	Acceleration Time 2	Sets the time to accelerate from 0 to maximum frequency when Accel/Decel times 2 are selected by a digital input.			O	202	93
C1-04 </>	Deceleration Time 2	Sets the time to decelerate from maximum frequency to 0 when Accel/Decel times 2 are selected by a digital input.			O	203	93
C1-09	Fast-Stop Time	Sets the time to decelerate from maximum frequency to 0 for the multi-function input fast-stop function. <b>Note:</b> This parameter is also used by selecting “Fast-Stop” as a Stop Method when a fault is detected.			O	208	–
<b>C2: S-Curve Characteristics</b> Use C2 parameters to configure S-curve operation.							

## B.2 Parameter Table

No.	Name	Description	Range	Def.	Mode	Addr. Hex	Pg.
C2-01	S-Curve Characteristic at Accel Start	<p>The S-curve can be controlled in the four points shown below.</p>	0.00 to 10.00	0.20 s	O	20B	-
C2-02	S-Curve Characteristic at Accel End		0.00 to 10.00	0.20 s	O	20C	-
C2-03	S-Curve Characteristic at Decel Start		0.00 to 10.00	0.20 s	O	20D	-
C2-04	S-Curve Characteristic at Decel End		0.00 to 10.00	0.00 s	O	20E	-
<b>C3: Slip Compensation</b> Use C3 parameters to configure the slip compensation function.							
C3-01	Slip Compensation Gain	Sets the slip compensation gain. Decides for what amount the output frequency is boosted in order to compensate the slip. <b>Note:</b> Adjustment is not normally required.	0.0 to 2.5	0.0	O	20F	-
C3-02	Slip Compensation Primary Delay Time	Adjusts the slip compensation function delay time. Decrease the setting when the slip compensation response is too slow, increase it when the speed is not stable.	0 to 10000	2000 ms	O	210	-
<b>C4: Torque Compensation</b> Use C4 parameters to configure Torque Compensation function.							
C4-01	Torque Compensation Gain	Sets the gain for the automatic torque (voltage) boost function and helps to produce better starting torque. Increase this setting when using a long motor cable or when the motor is significantly smaller than the drive capacity. Decrease this setting when motor oscillation occurs. Set the value so that the current at low speed does not exceeds the drive rated current.	0.00 to 2.50	1.00	O	215	-
<b>C6: Carrier Frequency</b> Use C6 parameters to configure the carrier frequency drive settings.							
C6-01	Drive Duty Selection	Selects the load rating for the drive. 0: Heavy Duty (HD) for constant torque applications. 1: Normal Duty (ND) for variable torque applications. This setting affects the Rated output current and overload tolerance of the drive.	0, 1	1	S	223	95

## B.2 Parameter Table

No.	Name	Description	Range	Def.	Mode	Addr. Hex	Pg.
C6-02	Carrier Frequency Selection	Selects the carrier frequency 1 : 2.0 kHz 2 : 5.0 kHz 3 : 8.0 kHz 4 : 10.0 kHz 5 : 12.5 kHz 6 : 15.0 kHz 7 : Swing PWM 8 to E : No setting possible F : User defined (determined by C6-03 through C6-05)	1 to F	<2>	S	224	95
C6-03	Carrier Frequency Upper Limit	C6-03 and C6-04 set upper and lower limits for the carrier frequency. <b>Note:</b> Set C6-02 to F before setting C6-03.	1.0 to 15.0	<3>	O	225	–
C6-04	Carrier Frequency Lower Limit	 <p>The coefficient K depends on C6-03:                      C6-03 ≥ 10.0 kHz: K = 3                      10.0 kHz &gt; C6-03 ≥ 5.0 kHz: K = 2                      5.0 kHz &gt; C6-03: K = 1                      When C6-05 ≤ 6, C6-04 is disabled (makes the carrier frequency C6-03 value).</p>	1.0 to 15.0	<3>	O	226	–
C6-05	Carrier Frequency Proportional Gain	Sets the relationship of output frequency to carrier frequency when C6-02 = F.	00 to 99	<3>	O	227	–

- <1> Parameter can be changed during run.
- <2> Default setting value is dependent on parameter o2-04, Drive Model Selection and C6-01, Drive Duty Selection.
- <3> Default setting value is dependent on parameter C6-02, Carrier Frequency Selection.

## B.2 Parameter Table

### ◆ d: References

Reference parameters are used to set the various frequency reference values during operation.

No.	Name	Description	Range	Def.	Mode	Addr. Hex	Pg.
<b>d1: Frequency Reference</b> Use d1 parameters to configure the drive frequency reference.							
d1-01 </>	Frequency Reference 1	Frequency reference. <i>Refer to Frequency Reference Source: b1-01 on page 88</i> for instructions to use d1-01 as the main frequency reference.	0.00 to 400.00 Hz <2>	0.00 Hz	S	280	97
d1-02 </>	Frequency Reference 2	Frequency reference when digital input "Multi-Step Speed Reference 1" (H1-□□ = 3) is on.		0.00 Hz	S	281	97
d1-03 </>	Frequency Reference 3	Frequency reference when digital input "Multi-Step Speed Reference 2" (H1-□□ = 4) is on.		0.00 Hz	S	282	97
d1-04 </>	Frequency Reference 4	Frequency reference when digital inputs "Multi-Step Speed Reference 1, 2" (H1-□□ = 3 and 4) are on.		0.00 Hz	S	283	97
d1-05 </>	Frequency Reference 5	Frequency reference when digital input "Multi-Step Speed Reference 3" (H1-□□ = 5) is on.		0.00 Hz	O	284	–
d1-06 </>	Frequency Reference 6	Frequency reference when digital inputs "Multi-Step Speed Reference 1, 3" (H1-□□ = 3 and 5) are on.		0.00 Hz	O	285	–
d1-07 </>	Frequency Reference 7	Frequency reference when digital inputs "Multi-Step Speed Reference 2, 3" (H1-□□ = 4 and 5) are on.		0.00 Hz	O	286	–
d1-08 </>	Frequency Reference 8	Frequency reference when multi-function input "Multi-Step speed reference 1, 2, 3" (H1-□□ = 3, 4, 5) are on.		0.00 Hz	O	287	–
d1-17 </>	Jog Frequency Reference	Frequency reference when digital inputs "Jog Frequency Reference", "Forward Jog" or "Reverse Jog." are on.		6.00 Hz	S	292	–
<b>d2: Frequency Upper and Lower Limits</b> Use d2 parameters to configure the frequency reference limits.							
d2-01	Frequency Reference Upper Limit	Sets the frequency reference upper limit as a percentage of maximum output frequency (E1-04). Output speed is limited to this value even if the frequency reference is higher. This limit applies to all frequency reference sources.	0.0 to 110.0	100.0%	O	289	–
d2-02	Frequency Reference Lower Limit	Sets the frequency reference lower limit as a percentage of maximum output frequency (E1-04). Output speed is limited to this value even if the frequency reference is lower. This limit applies to all frequency reference sources.	0.0 to 110.0	0.0%	O	28A	–
<b>d3: Jump Frequency</b> Use d3 parameters to configure the drive Jump Frequency settings.							

## B.2 Parameter Table

No.	Name	Description	Range	Def.	Mode	Addr. Hex	Pg.
d3-01	Jump Frequency 1	d3-01 to d3-04 allow programming of three prohibited frequency reference points for eliminating problems with resonant vibration of the motor/machine. This feature does not eliminate the selected frequency values, but accelerates and decelerates the motor through the prohibited bandwidth. The parameters must be according to the rule $d3-01 \geq d3-02$ .	0.0 to 400.0	0.0 Hz	O	294	-
d3-02	Jump Frequency 2			0.0 Hz	O	295	-
d3-04	Jump Frequency Width	This parameter sets the dead-band width around each selected prohibited frequency reference point. The bandwidth becomes the designated Jump frequency, plus or minus d3-04.	0.0 to 20.0	1.0 Hz	O	297	-
<b>d4: Frequency Reference Hold</b> Use d4 parameters to configure the drive frequency reference hold function.							
d4-01	Frequency Reference Hold Function Selection	Determines if the frequency reference or frequency reference bias is saved when the Run command is removed or the power goes off. 0: Disabled 1: Enabled This parameter is effective when the multi-function inputs "Accel/Decel Ramp Hold" or "Up/Down" commands are selected ( $H1-\square\square = A$ or 10/11).	0, 1	0	O	298	-

<1> Parameter can be changed during run.

<2> Range upper limit is dependent on parameters E1-04, Maximum Output Frequency, and d2-01, Frequency Reference Upper Limit.

## B.2 Parameter Table

### ◆ E: Motor Parameters

E parameters set V/f characteristics and motor-related data.

No.	Name	Description	Range	Def.	Mode	Addr. Hex	Pg.	
<b>E1: V/f Pattern Characteristics</b> Use E1 parameters to set V/f characteristics for the motor.								
E1-01 <I>	Input Voltage Setting	This parameter must be set to the power supply voltage. <b>WARNING!</b> Drive input voltage (not motor voltage) must be set in E1-01 for the protective features of the drive to function properly. Failure to do so may result in equipment damage and/or death or personal injury.	155 to 255	230	S	300	101	
E1-03	V/f Pattern Selection	F: Custom V/f. E1-04 through E1-10 settings define the V/f pattern.	F	F	O	302	—	
E1-04	Maximum Output Frequency	E1-04, E1-06 to E1-10 can only be changed when E1-03 is set to F. To set linear V/f characteristics, set the same values for E1-07 and E1-09. In this case, the setting for E1-08 will be disregarded. Ensure that the four frequencies are set according to these rules to prevent triggering an oPE10 fault: $E1-09 \leq E1-07 < E1-06 \leq E1-04$ VACrms Out (V)	40.0 to 400.0	60 Hz	S	303	101	
E1-05 <I>	Maximum Output Voltage		0.0 to 255.0	230 V	S	304	101	
E1-06	Base Frequency		0.0 to E1-04	60 Hz	O	305	101	
E1-07	Middle Output Frequency		0.0 to E1-04	3.0 Hz	O	306	101	
E1-08 <I>	Middle Output Frequency Voltage		0.0 to 255.0	18.4 V	O	307	101	
E1-09	Minimum Output Frequency		0.0 to E1-04	1.5 Hz	S	308	101	
E1-10 <I>	Minimum Output Voltage		0.0 to 255.0	13.8 V	O	309	101	
<b>E2: Motor Parameters</b> Use E2 parameters to set motor-related data.								
E2-01	Motor Rated Current		Sets the motor nameplate full load current in amperes. <b>Note:</b> Set E2-03 (Motor No-Load Current) before making changes to E2-01. Setting E2-01 < E2-03 will trigger an oPE02 error.	10 to 200% of drive rated current	<2>	S	30E	104
E2-02	Motor Rated Slip		Sets the motor rated slip in Hertz.	0.00 to 20.00	<2>	O	30F	104

No.	Name	Description	Range	Def.	Mode	Addr. Hex	Pg.
E2-03	Motor No-Load Current	Sets the magnetizing current of the motor in amperes. <b>Note:</b> Set E2-03 (Motor No-Load Current) before making changes to E2-01. Setting E2-01 < E2-03 will trigger an oPE02 error.	0 to less than E2-01	<2>	O	310	104
E2-05	Motor Line-to-Line Resistance	Sets the phase-to-phase motor resistance in ohms.	0.000 to 65.000 <3>	<2>	O	312	–

<1> Values shown here are for 200 V class drives. Double the value when using a 400 V class drive.

<2> Default setting value is dependent on parameter o2-04, Drive Model Selection and C6-01, Drive Duty Selection.

<3> Setting range becomes 0.00 to 130.00 for drives 0.2 kW and smaller.

## ◆ H Parameters: Multi-Function Terminals

H parameters assign functions to the multi-function input and output terminals.

No.	Name	Description	Range	Def.	Mode	Addr. Hex	Pg.
<b>H1: Multi-Function Digital Input</b>							
H1 parameters to assign functions to the multi-function digital input terminals. Unused terminals should be set to "F".							
H1-01	Multi-Function Digital Input Terminal S1 Function Selection	Assigns a function to the multi-function digital inputs. Refer to H1 Multi-Function Digital Input Selections on page 224 for a description of setting values.	1 to 67	40	O	438	–
H1-02	Multi-Function Digital Input Terminal S2 Function Selection			41	O	439	–
H1-03	Multi-Function Digital Input Terminal S3 Function Selection		0 to 67	24	O	400	–
H1-04	Multi-Function Digital Input Terminal S4 Function Selection			14	O	401	–
H1-05	Multi-Function Digital Input Terminal S5 Function Selection			3 (0) <1>	O	402	–

<1> Parenthetical value is the default when parameter A1-03 = 3330 3-Wire Initialization.

## B.2 Parameter Table

H1 Multi-Function Digital Input Selections			
H1-□□ Setting	Function	Description	Page
0	3-Wire Sequence	Closed: Reverse rotation (only if the drive is set up for 3-Wire sequence)	–
1	LOCAL/REMOTE Selection	Open: REMOTE, Run and frequency reference source set in b1-01/02 Closed: LOCAL, LED operator is run and reference source	–
2	Serial Communication Reference Selection	Open: REMOTE, Run and frequency reference source set in b1-01/02 Closed: MEMOBUS/Modbus Communication	–
3	Multi-Step Speed Reference 1	Used to select Multi-Step Speeds set in d1-01 to d1-08	–
4	Multi-Step Speed Reference 2		–
5	Multi-Step Speed Reference 3		–
6	Jog Reference Selection	Open: Selected speed reference Closed: Jog Frequency reference (d1-17). Jog has priority over all other reference sources.	–
7	Accel/Decel Time 1	Used to switch between Accel/Decel Time 1 and 2	–
8	Baseblock Command (N.O.)	Open: Normal operation Closed: No drive output	–
9	Baseblock Command (N.C.)	Open: No drive output Closed: Normal operation	–
A	Accel/Decel Ramp Hold	Closed: The drive pauses during acceleration or deceleration and maintains the output frequency.	–
F	Not used	Select this setting when not using the terminal or when using the terminal in a pass-through mode.	–
10	Up Command	Open: Maintains the current frequency reference Closed: Increases or decreases the current frequency reference.	–
11	Down Command	Ensure that the increase and decrease commands are set in conjunction with one another.	–
14	Fault Reset	Closed: Resets faults if the cause is cleared and the Run command is removed.	–
15	Fast-Stop (N.O.)	Closed: Decelerates at the Fast-Stop time C1-09. To restart the Fast-Stop input must be released and Run must be cycled.	–
17	Fast-stop (N.C.)	Open: Decelerates according to C1-09 (Fast-stop Time)	–



H1 Multi-Function Digital Input Selections			
H1-□□ Setting	Function	Description	Page
20 to 2F	External Fault	20: N.O., Always Detected, Ramp To Stop 21: N.C., Always Detected, Ramp To Stop 22: N.O., During Run, Ramp To Stop 23: N.C., During Run, Ramp To Stop 24: N.O., Always Detected, Coast To Stop 25: N.C., Always Detected, Coast To Stop 26: N.O., During Run, Coast To Stop 27: N.C., During Run, Coast To Stop 28: N.O., Always Detected, Fast-stop 29: N.C., Always Detected, Fast-stop 2A: N.O., During Run, Fast-stop 2B: N.C., During Run, Fast-stop 2C: N.O., Always Detected, Alarm Only (continue running) 2D: N.C., Always Detected, Alarm Only (continue running) 2E: N.O., During Run, Alarm Only (continue running) 2F: N.C., During Run, Alarm Only (continue running)	–
40	Forward Run Command (2-Wire sequence)	Open: Stop Closed: Forward run	–
41	Reverse Run Command (2-Wire sequence)	Open: Stop Closed: Reverse run	–
61	External Search Command 1	Closed: Activates Current Detection Speed Search from the max. output frequency (E1-04)	–
62	External Search Command 2	Closed: Activates Current Detection Speed Search from the frequency reference	–
67	Communications Test Mode	Tests the MEMOBUS/Modbus RS-422/485 interface.	–

No.	Name	Description	Range	Def.	Mode	Addr. Hex	Pg.
<b>H2: Multi-Function Digital Output MA-MB-MC</b>							
Use H2 parameters to assign functions to the multi-function digital output MA-MB-MC.							
H2-01	Terminal MA, MB and MC Function Selection (relay)	Refer to H2 Multi-Function Digital Output Settings on page 225 for a description of setting values.	0 to 13D	E	O	40B	105

H2 Multi-Function Digital Output Settings			
H2-01 Setting	Function	Description	Page
0	During Run	Closed: A Run command is active or voltage is output	–
1	Zero Speed	Closed: Output frequency is 0	–
2	Speed Agree 1	Closed: Output frequency equals the speed reference (plus or minus 2 Hz hysteresis)	–
4	Frequency Detection 1	Closed: Output frequency is less than or equal to the value in L4-01 with 2 Hz hysteresis	–

## B.2 Parameter Table

H2 Multi-Function Digital Output Settings			
H2-01 Setting	Function	Description	Page
5	Frequency Detection 2	Closed: Output frequency is greater than the value in L4-01 with 2 Hz hysteresis	–
6	Drive Ready	Closed: Drive Ready. The drive is powered up, not in a fault state, and in the Drive mode	–
7	DC Bus Undervoltage	Closed: DC bus voltage is below the $U_v$ trip level	–
8	During Baseblock (N.O.)	Closed: There is no output voltage	–
B	Torque Detection 1 (N.O.)	Closed: Output current/torque exceeds the torque value set in parameter L6-02 for longer than the time set in parameter L6-03	–
E	Fault	Closed: Fault occurred (other than CPF00 and CPF01)	–
F	Not used	Set this value when the terminal is not used, or when using the terminal in the pass-through mode	–
10	Minor Fault	Closed: An alarm is triggered	–
17	Torque Detection 1 (N.C.)	Open: When the output current exceeds the value set in parameter L6-02 for more time than is set in parameter L6-03	–
1A	Reverse Direction	Closed: Drive is running in the reverse direction	–
1E	Restart Enabled	Closed: An automatic restart is performed	–
3C	LOCAL/REMOTE Status	Closed: LOCAL Open: REMOTE	–
3D	Speed Search	Closed: Speed search is being executed	–
100 to 102; 104 to 108; 10B, 10E, 110, 117, 11A, 11E, 13C, 13D	H2 Parameter Functions Reversed Output Switching of 0 to 13D	Reverse the output switching of the multi-function output functions. Set the last two digits of $1\Box\Box$ to reverse the output signal of that specific function Examples: Setting “108” reverses the output of “During baseblock”, which is setting value 08 Setting “13C” reverses the output of “LOCAL/REMOTE Status”, which is setting “3C”	–

No.	Name	Description	Range	Def.	Mode	Addr. Hex	Pg.
<b>H3: Analog Input A1</b> Use H3 parameters to set the analog input terminal A1.							
H3-01	Terminal A1 Signal Level Selection	Sets the input level for terminal A1. 0: 0 to +10 V (lower limit) 1: 0 to +10 V (no lower limit) 2: 4 to 20 mA 3: 0 to 20 mA	0 to 3	0	O	410	–
H3-03 </>	Terminal A1 Gain Setting	Sets the level of the input value when 10 V (20 mA) is input at terminal A1.	-999.9 to 999.9	100.0%	O	411	–
H3-04 </>	Terminal A1 Bias Setting	Sets the level of the input value when 0 V (0 or 4 mA) is input at terminal A1.	-999.9 to 999.9	0.0%	O	412	–

No.	Name	Description	Range	Def.	Mode	Addr. Hex	Pg.
H3-13	Analog Input Filter Time Constant	Sets the primary delay filter time constant for terminal A1 or potentiometer (optional). Used for noise filtering.	0.00 to 2.00	0.03 s	O	41B	–

<1> Parameter can be changed during run.

No.	Name	Description	Range	Def.	Mode	Addr. Hex	Pg.
<b>H4: Multi-Function Analog Output AM</b>							
Use H4 parameters to configure the multi-function analog output terminal AM.							
H4-01	Multi-Function Analog Output Terminal AM	Selects the data to be output through multi-function analog output terminal AM. Set the desired monitor parameter to the digits available in U□-□□. For example, enter “103” for U1-03. When using this terminal in through mode or when not using it at all, set “000” or “031”.	000 to 999	102	O	41D	105
H4-02 </>	Multi-Function Analog Output Terminal AM Gain	Sets terminal AM output level when selected monitor is at 100%. Maximum output voltage is 10 V.	-999.9 to 999.9	100.0 %	S	41E	105
H4-03 </>	Multi-Function Analog Output Terminal AM Bias	Sets terminal AM output level when selected monitor is at 0%.	-999.9 to 999.9	0.0%	O	41F	105

<b>H5: MEMOBUS/Modbus Communications</b>							
Use H5 Parameters to connect the drive to a MEMOBUS/Modbus network. The settings for MEMOBUS/Modbus communications become effective when the drive is restarted.							
H5-01 <2>	Drive Slave Address	Selects drive slave number (address) for MEMOBUS/Modbus communication. Cycle power for the setting to take effect.	0 to FF	1F	O	425	–
H5-02	Comm. Speed Selection	Selects the baud rate for MEMOBUS/Modbus communication. Cycle power for the setting to take effect. 0 : 1200 bps 1 : 2400 bps 2 : 4800 bps 3 : 9600 bps 4 : 19200 bps 5 : 38400 bps	0 to 5	3	O	426	–
H5-03	Comm. Parity Selection	Selects the communication parity for MEMOBUS/Modbus communication. Cycle power for the setting to take effect. 0: No parity 1: Even parity 2: Odd parity	0 to 2	0	O	427	–

## B.2 Parameter Table

No.	Name	Description	Range	Def.	Mode	Addr. Hex	Pg.
H5-04	Stopping Method After Comm. Error	Selects the stopping method when a communication time-out fault (CE) is detected. 0: Ramp to stop 1: Coast to stop 2: Fast-stop 3: Alarm only	0 to 3	3	O	428	–
H5-05	Comm. Fault Detection Selection	Enables or disables the communications timeout fault (CE). 0: Disabled - A communication loss will not cause a communication fault. 1: Enabled - If communication is lost for more than 2 seconds, a CE fault will occur.	0, 1	1	O	429	–
H5-06	Drive Transmit Wait Time	Set the wait time between receiving and sending data.	10 to 65	10 ms	O	42A	–
H5-07	RTS Control Selection	Selects "request to send" (RTS) control: 0: Disabled - RTS is always on. 1: Enabled - RTS turns on only when sending.	0, 1	1	O	42B	–
H5-12	Run Command Method Selection	0: FWD/STOP, REV/STOP Method 1: RUN/STOP, FWD/REV Method	0, 1	0	O	43D	–
H5-13	MEMOBUS Freq. Reference and Freq. Monitor Unit	0: 0.1 Hz/1 1: 0.1-03 based 2: 100%/30000 3: 0.1%/1	0 to 3	0	O	43E	–

<1> Parameter can be changed during run.

<2> If this parameter is set to 0, the drive will be unable to respond to MEMOBUS/Modbus commands.

**Note:** Cycle power to the drive to enable MEMOBUS/Modbus settings.

◆ L: Protection Function

L parameters provide protection to the drive and motor, such as: control during momentary power loss, Stall Prevention, frequency detection, fault restarts, overtorque detection, and other types of hardware protection.

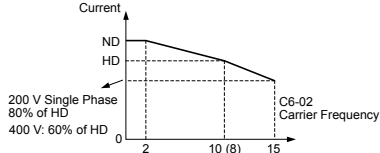
No.	Name	Description	Range	Def.	Mode	Addr. Hex	Pg.
<b>L1: Motor Protection Functions</b> Use L1 parameters to configure motor protective functions.							
L1-01	Motor Overload Protection Selection	Sets the motor thermal overload protection (oL1) based on the cooling capacity of the motor. 0: Disabled 1: General Purpose Motor (Standard Fan-Cooled) 2: Drive Dedicated Motor with a Speed Range of 1:10 <b>NOTICE:</b> When multiple motors are used the drive may not be able to provide protection, even if it is enabled in L1-01. Set L1-01 to “0” and ensure each motor has a thermal relay installed.	0 to 2	1	S	480	107
L1-02	Motor Overload Protection Time	Sets the motor thermal overload protection (oL1) time. A larger L1-02 time will increase the time for an oL1 fault to occur. This parameter does not typically require adjustment. Should be set in accordance with the overload tolerance of the motor.	0.1 to 20.0	8.0 min	O	481	107
L1-13	Continuous Electrothermal Operation Selection	Determines whether or not to hold the electrothermal value when the power supply is interrupted. 0: Disabled 1: Enabled	0, 1	1	O	46D	–
<b>L2: Momentary Power Loss</b> Use L2 parameters to configure drive functions for momentary power loss conditions.							
L2-01	Momentary Power Loss Operation Selection	Enables and disables the momentary power loss function. 0: Disabled - Drive trips on (Uv1) fault when power is lost. 1: Power Loss Ride-Thru Time - Drive will restart if power returns within the Power Loss Ride-Thru Time. 2: CPU Power Active - Drive will restart if power returns as long as the CPU is working.	0 to 2	0	O	485	–
<b>L3: Stall Prevention Function</b> Use L3 parameters to configure the Stall Prevention function.							

## B.2 Parameter Table

No.	Name	Description	Range	Def.	Mode	Addr. Hex	Pg.
L3-01	Stall Prevention Selection during Acceleration	Selects the Stall Prevention method used to prevent excessive current during acceleration. 0: Disabled - Motor accelerates at active acceleration rate. The motor may stall if load is too heavy or accel time is too short. 1: General Purpose - When output current exceeds L3-02 level, acceleration stops. Acceleration will continue when the output current level falls below the L3-02 level.	0, 1 </>	1	O	48F	-
L3-02	Stall Prevention Level during Acceleration	Used when L3-01 = 1. 100% is equal to the drive rated current. Decrease the set value if stalling or excessive current occurs with default setting.	0 to 150 </>	</>	O	490	-
L3-04	Stall Prevention Selection during Deceleration	When using a braking resistor, use setting "0". 0: Disabled - The drive decelerates at the active deceleration rate. If the load is too large or the deceleration time is too short, an ov fault may occur. 1: General Purpose - The drive decelerates at the active deceleration rate, but if the main circuit DC bus voltage reaches the Stall Prevention level, deceleration will stop. Deceleration will continue once the DC bus level drops below the Stall Prevention level. 4: Overexcitation Deceleration - Decelerates with the flux level determined by n3-13 (Overexcitation Gain).	0, 1, 4	1	S	492	-
L3-05	Stall Prevention Selection during Run	Selects the Stall Prevention method to use to prevent drive faults during run. 0: Disabled - Drive runs a set frequency. A heavy load may cause the drive to trip on an oC or oL fault. 1: Decel Time 1 - The drive will decelerate at Decel Time 1 (C1-02) if the output current exceeds the level set by L3-06. Once the current level drops below the L3-06 level, the drive will accelerate back to its frequency reference at the active acceleration rate. 2: Decel Time 2 - Same as setting 1 except the drive decelerates at Decel Time 2 (C1-04). When output frequency is 6 Hz or less, Stall Prevention during run is disabled regardless of the setting in L3-05.	0 to 2	1	O	493	-
L3-06	Stall Prevention Level during Run	Enabled when L3-05 is set to "1" or "2". 100% is equal to the drive rated current. Decrease the set value if stalling or excessive current occurs with the default settings. Upper level is determined by C6-01 and L8-38.	30 to 150 </>	</>	O	494	-
<b>L4: Frequency Detection</b> Use L4 parameters to configure frequency detection operation.							
L4-01	Speed Agreement Detection Level	These parameters configure the multi-function output (H2- 01 = 2, 4, 5) settings "Speed Agree 1", "Frequency Detection 1," and "Frequency detection 2".	0.0 to 400.0	0.0 Hz	O	499	-

No.	Name	Description	Range	Def.	Mode	Addr. Hex	Pg.
L4-07	Speed Agreement Detection Selection	0: No detection during baseblock. 1: Detection always enabled.	0, 1	0	O	470	-
<b>L5: Fault Reset</b> Use L5 parameters to configure Automatic Restart after fault.							
L5-01	Number of Auto Restart Attempts	Sets the counter for the number of times the drive attempts to restart when one of the following faults occurs: oC, oH1, ov, PF, rH, oL1, oL2, oL3, Uv1. When the drive operates without fault for 10 minutes, the counter will be reset.	0 to 10	0	O	49E	-
<b>L6: Overtorque Detection</b> Use L6 parameters to configure overtorque detection.							
L6-01	Torque Detection Selection 1	Selects the overtorque operation. Overtorque is determined by the settings in parameters L6-02 and L6-03. The multi-function output settings (H2- 01= B and 17) are also active if programmed. 0: Disabled 1: oL3 at Speed Agree - Alarm (overtorque detection only active during Speed Agree and operation continues after detection). 2: oL3 at RUN - Alarm (overtorque detection is always active and operation continues after detection). 3: oL3 at Speed Agree - Fault (overtorque detection only active during Speed Agree and drive output will shut down on an oL3 fault). 4: oL3 at RUN - Fault (overtorque detection is always active and drive output will shut down on an oL3 fault).	0 to 4	0	O	4A1	-
L6-02	Torque Detection Level 1	Sets the overtorque detection level. 100% is equal to the motor rated current.	0 to 300	150 %	O	4A2	-
L6-03	Torque Detection Time 1	Sets the length of time an overtorque condition must exist before Torque Detection is triggered.	0.0 to 10.0	0.1 s	O	4A3	-
<b>L8: Hardware Protection</b> Use L8 parameters to configure hardware protection functions.							
L8-01	Internal Dynamic Braking Resistor Protection Selection (ERF type)	Selects the Braking resistor when using a 3% duty cycle heatsink mounted braking resistor. This parameter does not enable or disable the braking transistor of the drive. 0: Resistor overheat protection disabled 1: Resistor overheat protection enabled	0, 1	0	O	4AD	-

## B.2 Parameter Table

No.	Name	Description	Range	Def.	Mode	Addr. Hex	Pg.
L8-05	Input Phase Loss Protection Selection	Selects the detection of input current phase loss, power supply voltage imbalance, or main circuit electrolytic capacitor deterioration. 0: Disabled 1: Enabled <b>Note:</b> This parameter is disabled in 200 V single-phase drives.	0, 1	1	O	4B1	-
L8-10	Heatsink Cooling Fan Operation Selection	Controls the heatsink cooling fan operation. 0: Run with timer (Fan operates only during run and for 60 seconds after stop.) 1: Run always (Cooling fan operates whenever the drive is powered up.)	0, 1	0	O	4B6	-
L8-12	Ambient Temperature Setting	Used to input the ambient temperature. This value adjusts the drive oL2 detection level.	-10 to 50	30 °C	O	4B8	-
L8-18	Soft Current Limit Selection	Selects the software current limit function. Typically no adjustment is required. 0: Disabled 1: Enabled	0, 1	1	O	4BE	-
L8-35 <3>	Installation Method Selection	Selects the installation type: 0: IP20/IP00 Drive 1: Side-by-Side Mounting 2: NEMA Type 1 Drive 3: Finless Drive or External Heatsink Installation	0 to 3	0	O	4EC	-
L8-38	Carrier Frequency Reduction	Provides protection to the IGBTs by reducing the carrier frequency at low speeds. 0: Disabled 1: Enabled below 6 Hz 2: Enabled for the whole speed range 	0 to 2	1	O	4EF	-

- <1> When enabled, the drive stops accelerating when it exceeds the value of L3-02, Stall Prevention Level. The drive decelerates after 100 ms and begins accelerating again after restoring the current level.
- <2> Default setting value is 120% when C6-01 is set to 1 (ND) and 150% when C6-01 is set to 0 (HD).
- <3> This parameter is not reset to the default value when the drive is reinitialized using A1-03.
- <4> The default setting and the upper limit of the setting range are determined by C6-01, Drive Duty Mode, and L8-38, Carrier Frequency Reduction Selection.



## ◆ n: Advanced Performance Set-Up

The n parameters are used to adjust more advanced performance characteristics.

No.	Name	Description	Range	Def.	Mode	Addr. Hex	Pg.
<b>n1: Hunting Prevention</b> Use n1 parameters to configure hunting prevention operation.							
n1-02	Hunting Prevention Gain Setting	Sets the gain for the Hunting Prevention Function. If the motor vibrates while lightly loaded, increase the gain by 0.1 until vibration ceases. If the motor stalls, decrease the gain by 0.1 until the stalling ceases.	0.00 to 2.50	1.00	O	581	-
<b>n3: Overexcitation Braking</b> Use n3 parameters to configure the overexcitation braking function.							
n3-13	Overexcitation Deceleration Gain	Applies a gain to the V/f pattern during deceleration (L3-04 = 4). Returns to normal values after ramp to stop or at re-acceleration. To increase the braking power of overexcitation, increase the gain by 1.25 to 1.30.	1.00 to 1.40	1.10	O	531	-

## ◆ o: Operator Related Parameters

o parameters are used to set up the LED digital operator displays.

No.	Name	Description	Range	Def.	Mode	Addr. Hex	Pg.
<b>o1: Display Settings</b> Use o1 parameters to configure the digital operator display.							
o1-02	User Monitor Selection After Power Up	Selects the information displayed when power is applied. 1: Frequency Reference (U1-01) 2: Forward/Reverse 3: Output Frequency (U1-02) 4: Output Current (U1-03)	1 to 4	1	O	501	-
o1-03	Digital Operator Display Selection	Sets the units to display the frequency reference and output frequency. 0: 0.01 Hz 1: 0.01% (100% = E1-04)	0, 1	0	O	502	-
<b>o2: Operator Keypad Functions</b> Use o2 parameters to configure LED digital operator key functions.							
o2-02	STOP Key Function Selection	Determines if the STOP key on the digital operator will stop the drive when operating from the external terminals or via serial communication. 0: Disabled 1: Enabled	0, 1	1	O	506	-

## B.2 Parameter Table

No.	Name	Description	Range	Def.	Mode	Addr. Hex	Pg.
o2-04	Drive Model Selection	Sets the drive model. This parameter only needs to be set when installing a new control board. Do not change for other reason.	0 to FF	dep. on drive spec.	O	508	–
o2-05	Frequency Reference Setting Method Selection	Selects if the ENTER key must be pressed when inputting the frequency reference by the operator keypad. 0: Data/Enter key must be pressed to enter a frequency reference. 1: Data/Enter key is not required. The output frequency changes immediately when the reference is changed by the UP or DOWN keys on the digital operator. The ENTER key does not need to be pressed. <b>Note:</b> When o2-05 is set to 1, the power supply to the drive must remain on for at least 5 seconds after making changes to the frequency reference.	0, 1	0	O	509	–
o2-06	Operation Selection when Digital Operator is Disconnected	Sets drive action when the digital operator is removed in LOCAL mode or with b1-02 = 0 (valid for optional remote operator only). 0: The drive will continue operation 1: The drive will trigger a fault (oPr) and the motor will coast to stop	0, 1	0	O	50A	–
o2-09	–	Factory use.	–	–	–	–	–
<b>o3: Copy Function</b>							
Use o3 parameters to Read, Copy and Verify the parameter settings to and from the drive.							
o3-01	Copy Function Selection	0: Copy select 1: INV → OP READ (Read parameters from the drive, saving them onto the digital operator.) 2: OP → INV WRITE (Copy parameters from the digital operator, writing them to the drive.) 3: OP → INV VERIFY (Verify parameter settings on the drive to check if they match the data saved on the operator.) To read the drive parameter settings into the digital operator, set o3-02 to 1 (to allow reading).	0 to 3	0	O	515	–
o3-02	Copy Allowed Selection	Locks the READ operation to prevent accidental overwriting of the data stored in the LED operator. 0: READ operation prohibited 1: READ operation allowed	0, 1	0	O	516	–
<b>o4: Maintenance Period</b>							
Use o4 parameters to perform maintenance.							
o4-01	Accumulated Operation Time Setting	Sets the value for the cumulative operation time of the drive in units of 10 h.	0 to 9999	0	O	50B	–
o4-02	Accumulated Operation Time Selection	Determines, how the cumulative operation time (U4-01) is counted. 0: Logs power-on time 1: Logs operation time when the drive output is active (output operation time).	0, 1	0	O	50C	–

No.	Name	Description	Range	Def.	Mode	Addr. Hex	Pg.
o4-03	Cooling Fan Operation Time Setting	Sets the value of the fan operation time in units of 10 h.	0 to 9999	0	O	50E	–
o4-05	Capacitor Maintenance Setting	Sets the value of the capacitor maintenance time monitor U4-05.	0 to 150	0%	O	51D	–
o4-07	DC Bus Pre-Charge Relay Maintenance Setting	Sets the value of the Soft Charge Bypass Relay Maintenance monitor U4-06.	0 to 150	0%	O	523	–
o4-09	IGBT Maintenance Setting	Sets the value of the IGBT Maintenance monitor U4-07.	0 to 150	0%	O	525	–
o4-11	U2 Initialization	0: U2-□□ monitor data are not reset when the drive is initialized using A1-03. 1: U2-□□ monitor data are reset when the drive is initialized using A1-03. (The value of o4-11 is automatically returned to 0.)	0, 1	0	O	510	–


















<1> Parameter can be changed during run.

### ◆ U: Monitors

Monitor parameters allow the user to view drive status, fault information, and other information about drive operation.

No.	Name	Description	Analog Output Level	Unit	Mode	Addr. Hex
<b>U1: Operation Status Monitors</b> Use U1 monitors to display the operation status of the drive.						
U1-01	Frequency Reference	Monitors the frequency reference	10 V: Max frequency	0.01 Hz	O	40
U1-02	Output Frequency	Displays the output frequency. Display units are determined by o1-03.	10 V: Max frequency	0.01 Hz	O	41
U1-03	Output Current	Displays the output current.	10 V: Drive rated current	0.01 A <1>	O	42
U1-06	Output Voltage Reference	Displays the output voltage.	10 V: 200 Vrms (400 Vrms)	0.1 V	O	45
U1-07	DC Bus Voltage	Displays the DC bus voltage.	10 V: 400 V (800 V)	1 V	O	46

## B.2 Parameter Table

No.	Name	Description	Analog Output Level	Unit	Mode	Addr. Hex
U1-10	Input Terminal Status	<p>Displays the input terminal status.</p>  <ul style="list-style-type: none"> <li> Digital input terminal S1 enabled</li> <li> Digital input terminal S2 enabled</li> <li> Digital input terminal S3 enabled</li> <li> Digital input terminal S4 enabled</li> <li> Digital input terminal S5 enabled</li> </ul>	No output signal available	–	O	49
U1-11	Output Terminal Status	<p>Displays the output terminal status.</p>  <ul style="list-style-type: none"> <li> Multi-Function Digital Output (fault) (terminal MA/MB-MC)</li> </ul>	No output signal available	–	O	4A
U1-13	Terminal Input Level	Displays analog input A1 level: 100% when input is 10 V or 20 mA.	10 V/20 mA: 100%	0.1%	O	4E
U1-19	MEMOBUS/Modbus Error Code	<p>Displays the contents of a MEMOBUS/Modbus error.</p>  <ul style="list-style-type: none"> <li> CRC Error</li> <li> Data Length Error</li> <li> Not Used</li> <li> Parity Error</li> <li> Overrun Error</li> <li> Framing Error</li> <li> Timed Out</li> <li> Not Used</li> </ul>	No output signal available	–	O	66
U1-25	Software No. (ROM)	ROM ID	No signal output avail.	–	O	4D
U1-26	Software No. (Flash)	Flash ID	No signal output avail.	–	O	5B

## B.2 Parameter Table

No.	Name	Description	Analog Output Level	Unit	Mode	Addr. Hex
<b>U2: Fault History</b> Use U2 monitors to view fault history data.						
U2-01	Current Fault	Displays the current fault.	No signal output avail.	–	O	80
U2-02	Previous Fault	Displays the previous fault. o4-11 resets the values for U2-02	No signal output avail.	–	O	81
<b>U4: Maintenance Monitors</b> Use U4 monitors to display drive maintenance information.						
U4-01 <3>	Accumulated Operation Time	Displays the cumulative operation time of the drive. The value for the cumulative operation time counter can be reset in parameter o4-01. Use parameter o4-02 to determine if the operation time should start as soon as the power is switched on or only while the run command is present. The maximum number displayed is 99999, after which the value is reset to 0.	No signal output avail.	1 h	O	4C
U4-04	Cooling Fan Maintenance	Displays main cooling fan usage time as a percentage of the expected performance life. Parameter o4-03 can be used to reset this monitor.	No signal output avail.	1%	O	7E
U4-05 <2>	Capacitor Maintenance	Displays main circuit capacitor usage time as a percentage of the expected performance life. Parameter o4-05 can be used to reset this monitor.	No signal output avail.	1%	O	7C
U4-06 <2>	Soft Charge Bypass Relay Maintenance	Displays the soft charge bypass relay maintenance time as a percentage of the estimated product life. Parameter o4-07 can be used to reset this monitor.	No signal output avail.	1%	O	7D6
U4-07 <2>	IGBT Maintenance	Displays IGBT usage time as a percentage of expected performance life. Parameter o4-09 can be used to reset this monitor.	No signal output avail.	1%	O	7D7
U4-08	Heatsink Temperature	Displays the heatsink temperature.	10 V: 100 °C	1 °C	O	68
U4-09	LED Check	Lights all segments of the LED to verify that the display is working properly.	No signal output avail.	–	O	3C
U4-13	Peak Hold Current	Displays the peak hold current during run.	No signal output avail.	0.01 A <1>	O	7CF

- <1> U1-03 and U4-13 display monitor contents in amp units. When reading the value of these monitors via MEMOBUS/Modbus, a value of 8192 is equal to 100% of the drive rated output current.
- <2> When this value reaches 100%, the maintenance period has been reached for the component in question and the drive is at risk of faulting out due to component failure. Periodically check the maintenance monitors to avoid this situation.
- <3> MEMOBUS/Modbus communications data is in 10 h units. If data in 1 h units are also required, refer to register 0099H.

# B.3 Defaults by Drive Model and Duty Rating ND/HD

**Table B.2 Single-Phase, 200 V Class Drives Default Settings by Drive Capacity and ND/HD Settings**

No.	Description	Unit	Default Settings					
			BA0001		BA0002		BA0003	
-	Model	-	30		31		32	
o2-04	Drive Model Selection	Hex	HD	ND	HD	ND	HD	ND
C6-01	Normal/Heavy Duty	-	0	1	0	1	0	1
-	Motor rated power	kW	0.1	0.18	0.25	0.37	0.55	0.75
C6-02	Carrier frequency	-	4	7	4	7	4	7
E2-01	Motor rated current	A	0.60	1.10	1.10	1.90	1.90	3.30
E2-02	Motor rated slip	Hz	2.50	2.60	2.60	2.90	2.90	2.50
E2-03	Motor no-load current	A	0.40	0.80	0.80	1.20	1.20	1.80
E2-05	Motor line-to-line resistance	Ω	35.98	20.56	20.56	9.84	9.842	5.156
-	Momentary power loss ride-through time	s	0.1	0.1	0.1	0.1	0.1	0.1
-	Mom. power loss Baseblock time	s	0.2	0.2	0.2	0.2	0.2	0.3

No.	Description	Unit	Default Settings			
			BA0006		BA0010	
-	Model	-	33		34	
o2-04	Drive Model Selection	Hex	HD	ND	HD	ND
C6-01	Normal/Heavy Duty	-	0	1	0	1
C6-02	Carrier frequency	-	4	7	3	7
E2-01	Motor rated current	A	3.30	6.20	6.20	8.50
E2-02	Motor rated slip	Hz	2.50	2.60	2.60	2.90
E2-03	Motor no-load current	A	1.80	2.80	2.80	3.00
E2-05	Motor line-to-line resistance	Ω	5.156	1.997	1.997	1.601
-	Momentary power loss ride-through time	s	0.2	0.2	0.3	0.3
-	Momentary power loss Baseblock time	s	0.3	0.4	0.4	0.5

### B.3 Defaults by Drive Model and Duty Rating ND/HD

**Table B.3 Three-Phase, 200 V Class Drives Default Settings by Drive Capacity and ND/HD Setting**

No.	Description	Unit	Default Settings									
			2A0001		2A0002		2A0004		2A0006		2A0010	
–	<b>Model</b>	–	<b>60</b>		<b>61</b>		<b>62</b>		<b>63</b>		<b>65</b>	
<b>o2-04</b>	<b>Drive Model Selection</b>	Hex	<b>60</b>		<b>61</b>		<b>62</b>		<b>63</b>		<b>65</b>	
<b>C6-01</b>	<b>Normal/Heavy Duty</b>	–	HD	ND	HD	ND	HD	ND	HD	ND	HD	ND
			<b>0</b>	<b>1</b>	<b>0</b>	<b>1</b>	<b>0</b>	<b>1</b>	<b>0</b>	<b>1</b>	<b>0</b>	<b>1</b>
–	<b>Motor rated power</b>	<b>kW</b>	<b>0.1</b>	<b>0.18</b>	<b>0.25</b>	<b>0.37</b>	<b>0.55</b>	<b>0.75</b>	<b>1.1</b>	<b>1.1</b>	<b>1.5</b>	<b>2.2</b>
C6-02	Carrier frequency	–	4	7	4	7	4	7	4	7	3	7
E2-01	Motor rated current	A	0.60	1.10	1.10	1.90	1.90	3.30	3.30	4.90	6.20	8.50
E2-02	Motor rated slip	Hz	2.50	2.60	2.60	2.90	2.90	2.50	2.50	2.60	2.60	2.90
E2-03	Motor no-load current	A	0.40	0.80	0.80	1.20	1.20	1.80	1.80	2.30	2.80	3.00
E2-05	Motor line-to-line resistance	Ω	35.98	20.56	20.56	9.84	9.842	5.156	5.156	3.577	1.997	1.601
–	Momentary power loss ride-through time	s	0.1	0.1	0.1	0.1	0.1	0.1	0.2	0.2	0.3	0.3
–	Momentary power loss Baseblock time	s	0.2	0.2	0.2	0.2	0.2	0.3	0.3	0.4	0.4	0.5

No.	Description	Unit	Default Settings			
			2A0012		2A0020	
–	<b>Model</b>	–	<b>2A0012</b>		<b>2A0020</b>	
<b>o2-04</b>	<b>Drive Model Selection</b>	Hex	<b>66</b>		<b>68</b>	
<b>C6-01</b>	<b>Normal/Heavy Duty</b>	–	HD	ND	HD	ND
			<b>0</b>	<b>1</b>	<b>0</b>	<b>1</b>
–	<b>Motor rated power</b>	<b>kW</b>	<b>2.2</b>	<b>3.0</b>	<b>4.0</b>	<b>5.5</b>
C6-02	Carrier frequency	–	3		7	
E2-01	Motor rated current	A	8.50		11.40	
E2-02	Motor rated slip	Hz	2.90		2.70	
E2-03	Motor no-load current	A	3.00		3.70	
E2-05	Motor line-to-line resistance	Ω	1.601		1.034	
–	Momentary power loss ride-through time	s	0.5		0.5	
–	Momentary power loss Baseblock time	s	0.5		0.5	

## B.3 Defaults by Drive Model and Duty Rating ND/HD

Table B.4 Three-Phase 400 V Class Drives Default Settings by Drive Capacity and ND/HD Setting

No.	Description	Unit	Default Settings							
			4A0001		4A0002		4A0004		4A0005	
–	Model	–	91		92		93		94	
o2-04	Drive Model Selection	Hex	HD	ND	HD	ND	HD	ND	HD	ND
C6-01	Normal/Heavy Duty	–	0	1	0	1	0	1	0	1
–	Motor rated power	kW	0.37	0.37	0.55	0.75	1.1	1.5	1.5	2.2
C6-02	Carrier frequency	–	3	7	3	7	3	7	3	7
E2-01	Motor rated current	A	0.60	1.00	1.00	1.60	1.60	3.10	3.10	4.20
E2-02	Motor rated slip	Hz	2.50	2.90	2.90	2.60	2.60	2.50	2.50	3.00
E2-03	Motor no-load current	A	0.40	0.60	0.60	0.80	0.80	1.40	1.40	1.50
E2-05	Motor line-to-line resistance	Ω	83.94	38.20	38.198	22.459	22.459	10.1	10.1	6.495
–	Momentary power loss ride-through time	s	0.1	0.1	0.1	0.1	0.2	0.2	0.3	0.3
–	Momentary power loss Baseblock time	s	0.2	0.2	0.2	0.3	0.3	0.4	0.4	0.5

No.	Description	Unit	Default Setting					
			4A0007		4A0009		4A0011	
–	Model	–	95		96		97	
o2-04	Drive Model Selection	–	HD	ND	HD	ND	HD	ND
C6-01	Normal/Heavy Duty	–	0	1	0	1	0	1
–	Motor rated power	kW	2.2	3.0	3.0	4.0	4.0	5.5
C6-02	Carrier frequency	–	3	7	3	7	3	7
E2-01	Motor rated current	A	4.20	5.70	5.70	7.00	7.00	9.80
E2-02	Motor rated slip	Hz	3.00	2.70	2.70	2.70	2.70	1.50
E2-03	Motor no-load current	A	1.50	1.90	1.90	2.30	2.30	2.60
E2-05	Motor line-to-line resistance	Ω	6.495	4.360	4.360	3.333	3.333	1.595
–	Momentary power loss ride-through time	s	0.5	0.5	0.5	0.5	0.5	0.5
–	Momentary power loss Baseblock time	s	0.5	0.5	0.5	0.6	0.6	0.7



# Appendix: C

## Standards Compliance

---

This appendix explains the guidelines and criteria for maintaining CE and UL standards.

<b>C.1</b>	<b>SECTION SAFETY.....</b>	<b>242</b>
<b>C.2</b>	<b>EUROPEAN STANDARDS.....</b>	<b>245</b>
<b>C.3</b>	<b>UL STANDARDS.....</b>	<b>254</b>

# C.1 Section Safety

### DANGER

#### Electrical Shock Hazard

**Do not connect or disconnect wiring while the power is on.**

Failure to comply will result in death or serious injury.

### WARNING

#### Electrical Shock Hazard

**Do not operate equipment with covers removed.**

Failure to comply could result in death or serious injury.

The diagrams in this section may show drives without covers or safety shields to show details. Be sure to reinstall covers or shields before operating the drives and run the drives according to the instructions described in this manual.

**Always ground the motor-side grounding terminal.**

Improper equipment grounding could result in death or serious injury by contacting the motor case.

**Do not touch any terminals before the capacitors have fully discharged.**

Failure to comply could result in death or serious injury.

Before wiring terminals, disconnect all power to the equipment. The internal capacitor remains charged even after the power supply is turned off. The charge indicator LED will extinguish when the DC bus voltage is below 50 Vdc. To prevent electric shock, wait at least one minute after all indicators are off and measure the DC bus voltage level to confirm safe level.

**Do not allow unqualified personnel to perform work on the drive.**

Failure to comply could result in death or serious injury.

Installation, maintenance, inspection, and servicing must be performed only by authorized personnel familiar with installation, adjustment and maintenance of AC drives.

 **WARNING**

**Do not perform work on the drive while wearing loose clothing, jewelry or without eye protection.**

Failure to comply could result in death or serious injury.

Remove all metal objects such as watches and rings, secure loose clothing, and wear eye protection before beginning work on the drive.

**Do not remove covers or touch circuit boards while the power is on.**

Failure to comply could result in death or serious injury.

### **Fire Hazard**

**Tighten all terminal screws to the specified tightening torque.**

Loose electrical connections could result in death or serious injury by fire due to overheating of electrical connections.

**Do not use an improper voltage source.**

Failure to comply could result in death or serious injury by fire.

Verify that the rated voltage of the drive matches the voltage of the incoming power supply before applying power.

**Do not use improper combustible materials.**

Failure to comply could result in death or serious injury by fire.

Attach the drive to metal or other noncombustible material.

**Install adequate branch circuit protection according to applicable local codes and this manual.**

Failure to comply could result in fire and damage to the drive or injury to personnel. The device is suitable for use on a circuit capable of delivering not more than 31,000 RMS symmetrical amperes, 240 Vac maximum (200 V class) and 480 Vac maximum (400 V class) when protected by branch circuit protection devices specified in this manual.

### NOTICE

**Observe proper electrostatic discharge procedures (ESD) when handling the drive and circuit boards.**

Failure to comply may result in ESD damage to the drive circuitry.

**Never connect or disconnect the motor from the drive while the drive is outputting voltage.**

Improper equipment sequencing could result in damage to the drive.

**Do not use unshielded cable for control wiring.**

Failure to comply may cause electrical interference resulting in poor system performance. Use shielded twisted-pair wires and ground the shield to the ground terminal of the drive.

**Do not allow unqualified personnel to use the product.**

Failure to comply could result in damage to the drive or braking circuit.

Carefully review instruction manual TOBPC72060000 when connecting a braking option to the drive.

**Do not modify the drive circuitry.**

Failure to comply could result in damage to the drive and will void warranty.

Yaskawa is not responsible for modification of the product made by the user. This product must not be modified.

**Check all the wiring to ensure that all connections are correct after installing the drive and connecting other devices.**

Failure to comply could result in damage to the drive.

## C.2 European Standards



Figure C.1 CE Mark

The CE mark indicates compliance with European safety and environmental regulations and is required for engaging in business and commerce in Europe.

European standards include the Machinery Directive for machine manufacturers, the Low Voltage Directive for electronics manufacturers and the EMC guidelines for controlling noise.

This drive displays the CE mark based on the EMC guidelines and the Low Voltage Directive.

- **EMC Guidelines:** 2004/108/EC
- **Low Voltage Directive:** 2006/95/EC

### ◆ CE Low Voltage Directive Compliance

This drive has been tested according to IEC/EN 61800-5-1, and it fully complies with the Low Voltage Directive.

To comply with the Low Voltage Directive, be sure to meet the following conditions when combining this drive with other devices:

#### ■ Area of Use

Do not use drives in areas with pollution higher than severity 2 and overvoltage category 3 in accordance with IEC/EN 664.

#### ■ Factory Recommended Branch Circuit Protection

Yaskawa recommends installing one of the following types of branch circuit protection to maintain compliance with UL508C. Semiconductor protective type fuses are preferred. Alternate branch circuit protection devices are also listed in [Table C.1](#).

**NOTICE:** *If a fuse is blown or a Ground Fault Circuit Interrupter (GFCI) is tripped, check the wiring and the selection of peripheral devices to identify the cause. Contact Yaskawa before restarting the drive or the peripheral devices if the cause cannot be identified.*

## C.2 European Standards

**Table C.1 Factory Recommended Drive Branch Circuit Protection**

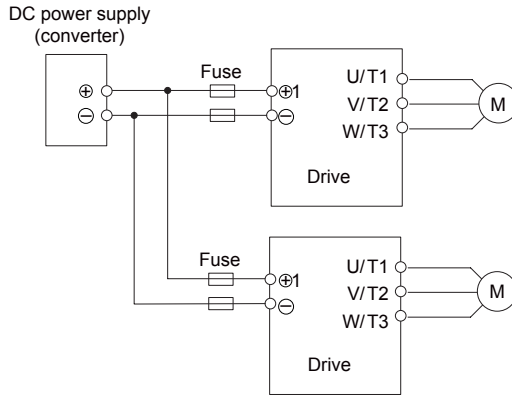
Drive Model	Fuse Type	
	Manufacturer: Bussmann	
	Model	Fuse Ampere Rating (A)
<b>Single-Phase 200 V Class</b>		
BA0001	FWH-25A14F	25
BA0002	FWH-25A14F	25
BA0003	FWH-60B	60
BA0006	FWH-80B	80
BA0010	FWH-100B	100
<b>Three-Phase 200 V Class</b>		
2A0001	FWH-25A14F	25
2A0002	FWH-25A14F	25
2A0004	FWH-25A14F	25
2A0006	FWH-25A14F	25
2A0010	FWH-70B	70
2A0012	FWH-70B	70
2A0020	FWH-90B	90
<b>Three-Phase 400 V Class</b>		
4A0001	FWH-40B	40
4A0002	FWH-40B	40
4A0004	FWH-50B	50
4A0005	FWH-70B	70
4A0007	FWH-70B	70
4A0009	FWH-90B	90
4A0011	FWH-90B	90

### ■ Grounding

The drive is designed to be used in T-N (grounded neutral point) networks. If installing the drive in other types of grounded systems, contact your dealer or Yaskawa for instructions.

### ■ CE Standards Compliance for DC Power Supply Input

Install the fuses in the following tables to meet CE standards.



**Figure C.2 Example of DC Power Supply Input (Two Drives Connected in Series)**

- Note:**
1. When connecting multiple drives together, make sure that each drive has its own fuse. Replace all fuses when one fuse blows.
  2. [Refer to on page 39](#) for an AC power supply.
  3. The recommended fuses and fuse holders are made by Fuji Electric.

**Table C.2 Single-Phase 200 V Class Fuses and Fuse Holders**

Drive Model	DC Power Supply Input				
	Fuse			Fuse Holder	
	Manufacturer: Fuji Electric				
	Type	Rated Short Circuit Braking Current (kA)	Qty.	Type	Qty.
BA0001	CR6L-20/UL	100	2	CMS-4	2
BA0002	CR6L-30/UL			CMS-4	
BA0003	CR6L-50/UL			CMS-4	
BA0006	CR6L-75/UL			CMS-5	
BA0010	CR6L-100/UL			CMS-5	

## C.2 European Standards

**Table C.3 Three-Phase 200 V Class Fuses and Fuse Holders**

Drive Model	DC Power Supply Input				
	Fuse			Fuse Holder	
	Manufacturer: Fuji Electric				
	Type	Rated Short Circuit Braking Current (kA)	Qty.	Type	Qty.
2A0001	CR6L-20/UL	100	2	CMS-4	2
2A0002	CR6L-20/UL			CMS-4	
2A0004	CR6L-20/UL			CMS-4	
2A0006	CR6L-30/UL			CMS-4	
2A0010	CR6L-50/UL			CMS-4	
2A0012	CR6L-50/UL			CMS-4	
2A0020	CR6L-75/UL			CMS-5	

**Table C.4 Three-Phase 400 V Class Fuses and Fuse Holders**

Drive Model	DC Power Supply Input				
	Fuse			Fuse Holder	
	Manufacturer: Fuji Electric				
	Type	Rated Short Circuit Braking Current (kA)	Qty.	Type	Qty.
4A0001	CR6L-20/UL	100	2	CMS-4	2
4A0002	CR6L-20/UL			CMS-4	
4A0004	CR6L-50/UL			CMS-4	
4A0005	CR6L-50/UL			CMS-4	
4A0007	CR6L-50/UL			CMS-4	
4A0009	CR6L-50/UL			CMS-4	
4A0011	CR6L-50/UL			CMS-4	

### ■ Guarding Against Harmful Materials

When installing IP20/Open-Chassis enclosure drives, use an enclosure that prevents foreign material from entering the drive from above or below.

### ◆ EMC Guidelines Compliance

This drive is tested according to EN 61800-3:2004/A1:2012 and it complies with the EMC guidelines.



### ■ EMC Filter Installation

The following conditions must be met to ensure continued compliance with guidelines. *Refer to EMC Filters on page 252* for EMC filter selection.

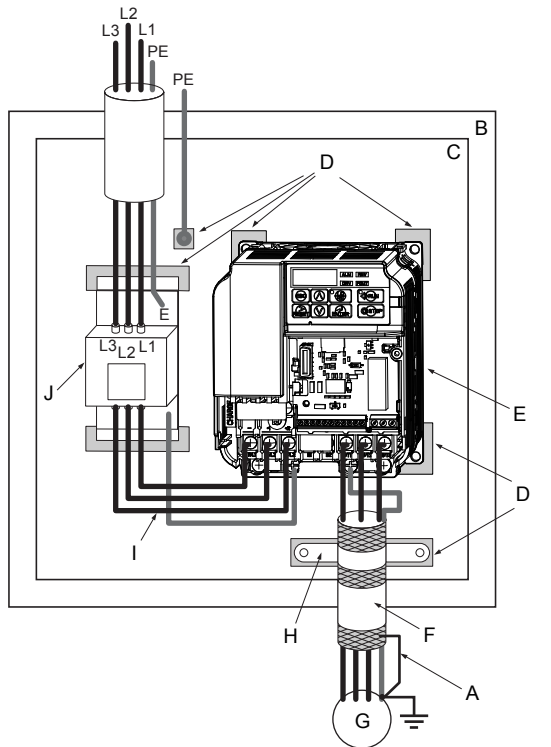
#### Installation Method

Verify the following installation conditions to ensure that other devices and machinery used in combination with this drive also comply with EMC guidelines.

1. Install an EMC noise filter to the input side specified by Yaskawa for compliance with European standards.
2. Place the drive and EMC noise filter in the same enclosure.
3. Use braided shield cable for the drive and motor wiring or run the wiring through a metal conduit.
4. Keep wiring as short as possible. Ground the shield on both the drive side and the motor side.
5. Ground the largest possible surface area of the shield to the metal conduit when using braided shield cable. Yaskawa recommends using a cable clamp.

## C.2 European Standards

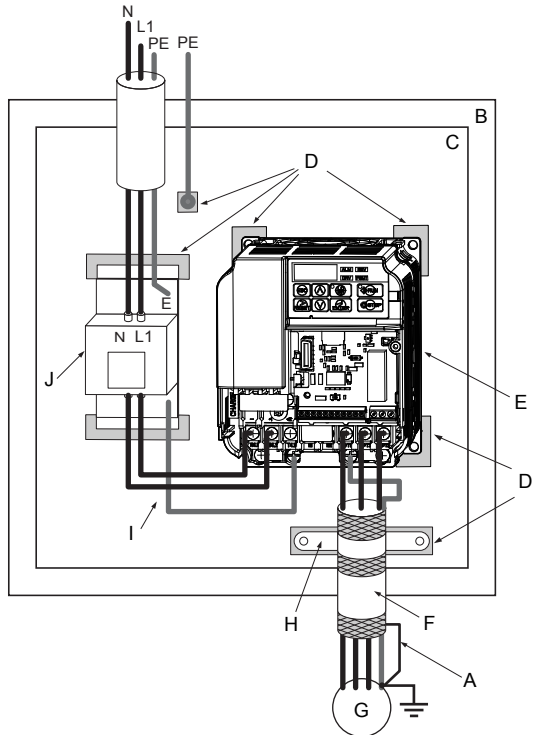
### Three-Phase 200 V / 400 V Class



- |  |   |
|--|---|
| A – Ground the cable shield                            | F – Motor cable (braided shield cable, max. 20 m) |
| B – Enclosure panel                                    | G – Motor   |
| C – Metal plate  | H – Cable clamp                                   |
| D – Grounding surface<br>(remove any paint or sealant) | I – Wiring distance as short as possible          |
| E – Drive  | J – EMC noise filter                              |

Figure C.3 EMC Filter and Drive Installation for CE Compliance  
(Three-Phase 200 V / 400 V Class)

Single-Phase 200 V Class



- |   |   |
|---|---|
| A – Ground the cable shield                         | F – Motor cable (braided shield cable, max. 20 m) |
| B – Enclosure panel                                 | G – Motor   |
| C – Metal plate                                     | H – Cable clamp                                   |
| D – Grounding surface (remove any paint or sealant) | I – Wiring distance as short as possible          |
| E – Drive   | J – EMC noise filter                              |

Figure C.4 EMC Filter and Drive Installation for CE Compliance (Single-Phase 200 V Class)

## C.2 European Standards

### ■ EMC Filters

Install the drive with the EMC filters listed below to comply with the EN 61800-3:2004/A1:2012, category C1 requirements.

**Table C.5 EN 61800-3:2004/A1:2012 Category C1 Filters**

Drive Model	Filter Data (Manufacturer: Schaffner)						
	Type	Rated Current (A)	Weight (lb)	Dimensions [W x L x H] (in)	Mounting Dimensions [Y x X] (mm)	Drive Mounting Screw A	Filter Mounting Screw
<b>200 V Single-Phase Units</b>							
BA0001	FS23638-10-07	10	0.97	2.8 x 6.7 x 1.8	2.0 x 6.1	M4	M5
BA0002	FS23638-10-07	10	0.97	2.8 x 6.7 x 1.8	2.0 x 6.1	M4	M5
BA0003	FS23638-10-07	10	0.97	2.8 x 6.7 x 1.8	2.0 x 6.1	M4	M5
BA0006	FS23638-20-07	20	1.65	4.4 x 6.7 x 2.0	3.6 x 6.1	M4	M5
BA0010	FS23638-20-07	20	1.65	4.4 x 6.7 x 2.0	3.6 x 6.1	M4	M5
<b>200 V Three-Phase Units</b>							
2A0001	FS23637-8-07	7.3	0.88	2.8 x 6.7 x 1.6	2.0 x 6.1	M4	M5
2A0002	FS23637-8-07	7.3	0.88	2.8 x 6.7 x 1.6	2.0 x 6.1	M4	M5
2A0004	FS23637-8-07	7.3	0.88	2.8 x 6.7 x 1.6	2.0 x 6.1	M4	M5
2A0006	FS23637-8-07	7.3	0.88	2.8 x 6.7 x 1.6	2.0 x 6.1	M4	M5
2A0010	FS23637-14-07	14	1.28	4.4 x 6.7 x 1.8	3.6 x 6.1	M4	M5
2A0012	FS23637-14-07	14	1.28	4.4 x 6.7 x 1.8	3.6 x 6.1	M4	M5
2A0020	FS23637-24-07	24	1.98	5.7 x 6.9 x 2.0	4.7 x 6.1	M4	M5
<b>400 V Three-Phase Units</b>							
4A0001	FS23639-5-07	5	1.10	4.4 x 6.7 x 1.8	3.6 x 6.1	M4	M5
4A0002	FS23639-5-07	5	1.10	4.4 x 6.7 x 1.8	3.6 x 6.1	M4	M5
4A0004	FS23639-5-07	5	1.10	4.4 x 6.7 x 1.8	3.6 x 6.1	M4	M5
4A0005	FS23639-10-07	10	1.54	4.4 x 6.7 x 1.8	3.6 x 6.1	M4	M5
4A0007	FS23639-10-07	10	1.54	4.4 x 6.7 x 1.8	3.6 x 6.1	M4	M5
4A0009	FS23639-10-07	10	1.54	4.4 x 6.7 x 1.8	3.6 x 6.1	M4	M5
4A0011	FS23639-15-07	15	1.98	5.7 x 6.9 x 2.0	4.7 x 6.3	M4	M5

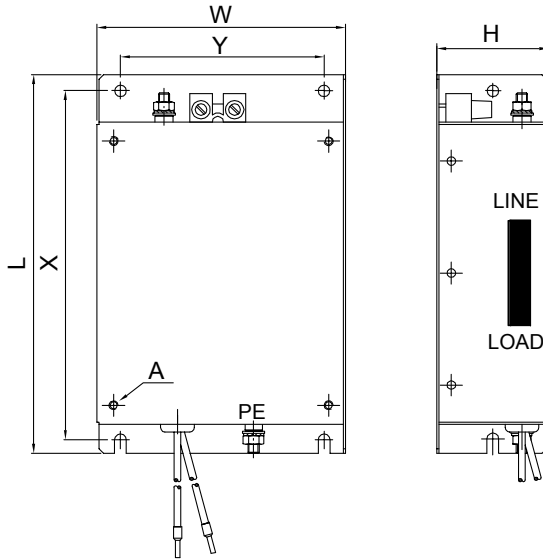


Figure C.5 EMC Filter Dimensions

### ■ DC Link Chokes for IEC/EN 61000-3-2 Compliance

Table C.6 DC Link Chokes for Harmonics Reduction

Drive Model	DC Link Choke	
	Model	Rating
<b>200V Three-Phase Units</b>		
2A0004	UZDA-B	5.4 A 8 mH
2A0006		
<b>400 V Three-Phase Units</b>		
4A0002	UZDA-B	3.2 A 28 mH
4A0004		

**Note:** Models not listed in the above table do not require a DC link choke for EMC compliance.

# C.3 UL Standards

---

## ◆ UL Standards Compliance

The UL/cUL mark applies to products in the United States and Canada indicates that UL has performed product testing and evaluation and determined that their stringent standards for product safety have been met. For a product to receive UL certification, all components inside that product must also receive UL certification.



Figure C.6 UL/cUL Mark

This drive is tested in accordance with UL standard UL508C, E131457 and complies with UL requirements. The following conditions must be met to maintain compliance when using this drive in combination with other equipment:

### ■ Installation Area

Do not install the drive to an area greater than pollution severity 2 (UL standard).

### ■ Ambient Temperature

IP20/NEMA Type 1 enclosure: -10 °C to +40 °C (14 °F to 104 °F)

IP20/IP00 Open-Chassis enclosure: -10 °C to +50 °C (14 °F to 122 °F)

Finless Type: IP20 enclosure: -10 °C to +50 °C (14 °F to 122 °F)

### ■ Main Circuit Terminal Wiring

Yaskawa recommends using closed-loop crimp terminals on all drive models. UL/cUL approval requires the use of UL Listed closed-loop crimp terminals when wiring the drive main circuit terminals. Use only the tools recommended by the terminal manufacturer for crimping. The wire gauges listed in [Table C.7](#), [Table C.8](#), and [Table C.9](#) are Yaskawa recommendations. Refer to local codes for proper wire gauge selections.

**Table C.7 Wire Gauge and Torque Specifications**

Drive Model	Terminal	Recomm. Gauge AWG, kcmil	Wire Range AWG, kcmil	Screw Size	Tightening Torque N·m (lb.in.)
BA0001 BA0002 BA0003	R/L1, S/L2, T/L3	14	18 to 14	M3.5	0.8 to 1.0 (7.1 to 8.9)
	U/T1, V/T2, W/T3	14	18 to 14		
	ϕ, ϕ1, ϕ2	–	18 to 14		
	B1, B2	–	18 to 14		
	⊕	14	18 to 14		
BA0006	R/L1, S/L2, T/L3	12	14 to 10	M4	1.2 to 1.5 (10.6 to 13.3)
	U/T1, V/T2, W/T3	14	14 to 10		
	ϕ, ϕ1, ϕ2	–	14 to 10		
	B1, B2	–	14 to 10		
	⊕	10	14 to 10		
BA0010	R/L1, S/L2, T/L3	10	14 to 10	M4	1.2 to 1.5 (10.6 to 13.3)
	U/T1, V/T2, W/T3	14	14 to 10		
	ϕ, ϕ1, ϕ2	–	14 to 10		
	B1, B2	–	14 to 10		
	⊕	10	14 to 10		

**Table C.8 Wire Gauge and Torque Specifications**

Drive Model	Terminal	Recomm. Gauge AWG, kcmil	Wire Range AWG, kcmil	Screw Size	Tightening Torque N·m (lb.in.)
2A0001 2A0002 2A0004 2A0006	R/L1, S/L2, T/L3	14	18 to 14	M3.5	0.8 to 1.0 (7.1 to 8.9)
	U/T1, V/T2, W/T3	14	18 to 14		
	ϕ, ϕ1, ϕ2	–	18 to 14		
	B1, B2	–	18 to 14		
	⊕	14	18 to 14		
2A0010	R/L1, S/L2, T/L3	14	14 to 10	M4	1.2 to 1.5 (10.6 to 13.3)
	U/T1, V/T2, W/T3	14	14 to 10		
	ϕ, ϕ1, ϕ2	–	14 to 10		
	B1, B2	–	14 to 10		
	⊕	10	14 to 10		



## C.3 UL Standards

Drive Model	Terminal	Recomm. Gauge AWG, kcmil	Wire Range AWG, kcmil	Screw Size	Tightening Torque N•m (lb.in.)
2A0012	R/L1, S/L2, T/L3	12	14 to 10	M4	1.2 to 1.5 (10.6 to 13.3)
	U/T1, V/T2, W/T3	14	14 to 10		
	ϕ, ϕ1, ϕ2	–	14 to 10		
	B1, B2	–	14 to 10		
	⊕	10	14 to 10		
2A0020	R/L1, S/L2, T/L3	10	14 to 10	M4	1.2 to 1.5 (10.6 to 13.3)
	U/T1, V/T2, W/T3	10	14 to 10		
	ϕ, ϕ1, ϕ2	–	14 to 10		
	B1, B2	–	14 to 10		
	⊕	10	14 to 10		

**Table C.9 Wire Gauge and Torque Specifications**

Drive Model	Terminal	Recomm. Gauge AWG, kcmil	Wire Range AWG, kcmil	Screw Size	Tightening Torque N•m (lb.in.)
4A0001 4A0002 4A0004	R/L1, S/L2, T/L3	14	14 to 10	M4	1.2 to 1.5 (10.6 to 13.3)
	U/T1, V/T2, W/T3	14	14 to 10		
	ϕ, ϕ1, ϕ2	–	14 to 10		
	B1, B2	–	14 to 10		
	⊕	14	14 to 10		
4A0005 4A0007 4A0009	R/L1, S/L2, T/L3	14	14 to 10	M4	1.2 to 1.5 (10.6 to 13.3)
	U/T1, V/T2, W/T3	14	14 to 10		
	ϕ, ϕ1, ϕ2	–	14 to 10		
	B1, B2	–	14 to 10		
	⊕	10	14 to 10		
4A0011	R/L1, S/L2, T/L3	12	14 to 10	M4	1.2 to 1.5 (10.6 to 13.3)
	U/T1, V/T2, W/T3	14	14 to 10		
	ϕ, ϕ1, ϕ2	–	14 to 10		
	B1, B2	–	14 to 10		
	⊕	10	14 to 10		

**Note:** Use crimp insulated terminals or insulated tubing for wiring these connections. Wires should have a continuous maximum allowable temperature of 75 °C 600 V UL approved vinyl sheathed insulation. Ambient temperature should not exceed 30 °C.



### Closed-Loop Crimp Terminal Recommendations

Yaskawa recommends crimp terminals made by JST and Tokyo DIP for the insulation cap.

**Table C.10** matches the wire gauges and terminal screw sizes with Yaskawa-recommended crimp terminals, tools, and insulation caps. Refer to the appropriate Wire Gauge and Torque Specifications table for the wire gauge and screw size for your drive model. Place orders with a Yaskawa representative or the Yaskawa sales department.

The closed-loop crimp terminal sizes and values listed in **Table C.10** are Yaskawa recommendations. Refer to local codes for proper selections.

**Table C.10 Closed-Loop Crimp Terminal Sizes**

Wire Gauge	Terminal Screws	Crimp Terminal Model Number	Tool		Insulation Cap Model No.	Code <1>
			Machine No.	Die Jaw		
18 AWG	M3.5	R1.25-3.5	YA-4	AD-900	TP-003	100-066-217
16 AWG	M3.5	R1.25-3.5	YA-4	AD-900	TP-003	100-066-217
14 AWG	M3.5	R2-3.5	YA-4	AD-900	TP-003	100-066-218
	M4	R2-4	YA-4	AD-900	TP-003	100-054-028
12 / 10 AWG	M4	R5.5-4	YA-4	AD-900	TP-005	100-054-029

<1> Codes refer to a set of three crimp terminals and three insulation caps. Prepare input and output wiring using two sets for each connection.

Example: Models with 14 AWG for both input and output require one set for input terminals and one set for output terminals, so the user should order two sets of [100-066-218].

**Note:** Consider the amount of voltage drop when selecting wire gauges. Increase the wire gauge when the voltage drop is greater than 2% of motor rated voltage. Ensure the wire gauge is suitable for the terminal block. Use the following formula to calculate the amount of voltage drop:  
 Line drop voltage (V) =  $\sqrt{3} \times \text{wire resistance } (\Omega/\text{km}) \times \text{wire length (m)} \times \text{current (A)} \times 10^{-3}$

### ■ Factory Recommended Branch Circuit Protection

Yaskawa recommends installing one of the following types of branch circuit protection to maintain compliance with UL508C. Semiconductor protective type fuses are preferred.

Branch circuit protection shall be provided by any of the following according to **Table C.11**.

- Non-time Delay Class J, T, or CC fuses.
- Time Delay Class J, T, CC, or RK5 fuses.
- Semiconductor fuses.
- Molded Case Circuit Breakers (MCCB).

## C.3 UL Standards

Table C.11 Factory Recommended Drive Branch Circuit Protection

Drive Model	Non-time Delay Fuse Rating (A) <1>	Time Delay Fuses		Bussmann Semiconductor Fuse Part Number (Fuse Ampere) <4>	MCCB <5>	
		Class J, T, or CC Fuse Rating (A) <2>	Class RK5 Fuse Rating (A) <3>		Rating (A)	Minimum Enclosure Volume (in <sup>3</sup> )
<b>200 V Class Single-Phase Drives</b>						
BA0001	6	3.5	4	FWH-25A14F (25)	15	600
BA0002	10	6	8	FWH-25A14F (25)	15	600
BA0003	20	10	15	FWH-60B (60)	15	600
BA0006	40	20	30	FWH-80B (80)	30	1152
BA0010	40	35	45	FWH-100B (100)	50	1152
<b>200 V Class Three-Phase Drives</b>						
2A0001	3	1.5	2	FWH-25A14F (25)	15	600
2A0002	6 <6>	3	3	FWH-25A14F (25)	15	600
2A0004	15 <7>	6	8	FWH-25A14F (25)	15	600
2A0006	20	10	15	FWH-25A14F (25)	15	1152
2A0010	25	15	20	FWH-70B (70)	25	1152
2A0012	25	20	30	FWH-70B (70)	30	1152
2A0020	40	40	50	FWH-90B (90)	60	1152
<b>400 V Class Three-Phase Drives</b>						
4A0001	3	2	2	FWH-40B (40)	15	1152
4A0002	6	3.5	3	FWH-40B (40)	15	1152
4A0004	15 <7>	7	8	FWH-50B (50)	15	1152
4A0005	20 <8>	10	10	FWH-70B (70)	15	1152
4A0007	25 <9>	12	15	FWH-70B (70)	20	1152
4A0009	25	15	20	FWH-90B (90)	20	1152
4A0011	30	20	30	FWH-90B (90)	35	1152

- <1> Maximum 300% of drive input current rating for any Class J, T, or CC fuse except for models 2A0002, 2A0004, 4A0004, 4A0005, and 4A0007.
- <2> Maximum 175% of drive input current rating for any Class J, T, or CC fuse.
- <3> Maximum 225% of drive input current rating for any Class RK5 fuse.
- <4> When using semiconductor fuses, Bussmann FWH are required for UL compliance.
- <5> Maximum MCCB Rating is 15 A or 200% of drive input current rating, whichever is larger. MCCB voltage rating must be 600 Vac or greater. Additionally, when using MCCBs for protection, the drive must be installed in a ventilated enclosure with minimum volume according to the "Minimum Enclosure Volume" column.
- <6> Model 2A0002 requires Mersen (Ferraz) part number A6T6 for compliance.
- <7> Models 2A0004 and 4A0004 require Mersen (Ferraz) part number A6T15 for compliance.

- <8> Model 4A0005 requires Mersen (Ferraz) part number A6T20 for compliance.
- <9> Model 4A0007 requires Mersen (Ferraz) part number A6T25 for compliance.

## C.3 UL Standards

---

### ■ Low Voltage Wiring for Control Circuit Terminals

Wire low voltage wires with NEC Class 1 circuit conductors. Refer to national state or local codes for wiring. The external power supply shall be a UL-Listed Class 2 power source or equivalent.

Table C.12 Control Circuit Terminal Power Supply

Input / Output	Terminal Signal	Power Supply Specifications
Multi-function digital inputs	S1, S2, S3, S4, S5, SC	Use the internal power supply of the drive. Use class 2 for external power supply.
Main frequency reference	+V, A1, AC	Use the internal power supply of the drive. Use class 2 for external power supply.

### ■ Drive Short-Circuit Rating

This drive has undergone the UL short-circuit test, which certifies that during a short circuit in the power supply the current flow will not rise above 31,000 amps maximum at 240 V for 200 V class drives and 480 V for 400 V class drives.

- The MCCB and breaker protection and fuse ratings shall be equal to or greater than the short-circuit tolerance of the power supply being used.
- Suitable for use on a circuit capable of delivering not more than 31,000 RMS symmetrical amperes for 240 V in 200 V class drives (up to 480 V for 400 V class drives) motor overload protection.

---

### ◆ Drive Motor Overload Protection

Set parameter E2-01 (motor rated current) to the appropriate value to enable motor overload protection. The internal motor overload protection is UL listed and in accordance with the NEC and CEC.

#### ■ E2-01: Motor Rated Current

Setting Range: Model Dependent

Default Setting: Model Dependent

Parameter E2-01 (motor rated current) protects the motor if parameter L1-01 is not set to 0 (default is 1, standard induction motor protection enabled).

#### ■ L1-01: Motor Overload Protection Selection

The drive has an electronic overload protection function (oL1) based on time, output current and output frequency, which protects the motor from overheating. The electronic thermal overload function is UL-recognized, so it does not require an external thermal overload relay for single motor operation.

This parameter selects the motor overload curve used according to the type of motor applied.

Table C.13 Overload Protection Settings

Setting	Description
0	Disabled
1	General Purpose Motor (Standard Fan-Cooled) (default)
2	Drive Dedicated Motor with a Speed Range of 1:10

Disable the electronic overload protection (L1-01 = 0: Disabled) and wire each motor with its own motor thermal overload when connecting the drive to more than one motor for simultaneous operation.

Enable the motor overload protection (L1-01 = 1 or 2) when connecting the drive to a single motor unless there is another means of preventing motor thermal overload. The electronic thermal overload function causes an oL1 fault, which shuts off the output of the drive and prevents additional overheating of the motor. The motor temperature is continually calculated as long as the drive is powered up.

Setting L1-01 = 1 selects a motor with limited cooling capability below rated (base) speed when running at 100% load. The oL1 function derates the motor when it is running below base speed.

Setting L1-01 = 2 selects a motor capable of cooling itself over a 10:1 speed range when running at 100% load. The oL1 function derates the motor when it is running at 1/10 or less of its rated speed.

## ■ L1-02: Motor Overload Protection Time

Setting Range: 0.1 to 5.0 Minutes

Factory Default: 1.0 Minutes

The L1-02 parameter sets the allowed operation time before the oL1 fault occurs when the drive is running at 60 Hz and 150% of the full load amp rating (E2-01) of the motor. Adjusting the value of L1-02 can shift the set of oL1 curves up the Y-axis of the diagram below but will not change the shape of the curves.

### C.3 UL Standards

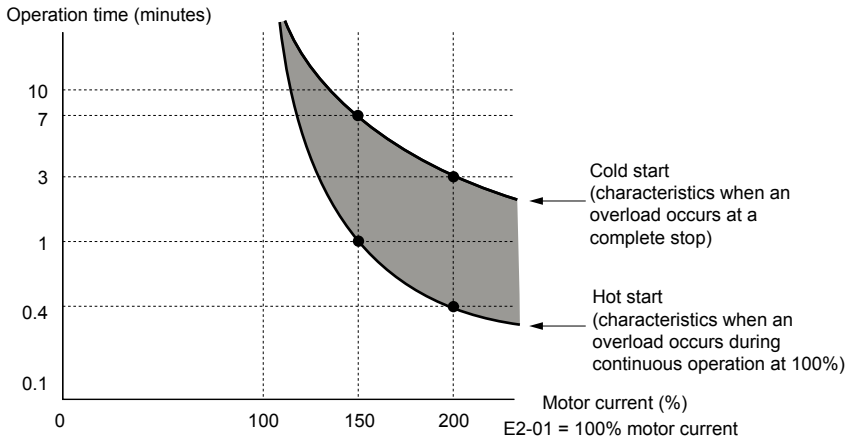


Figure C.7 Motor Overload Protection Time

# Index

## Numerics

2-Wire Initialization .....	88
2-Wire Sequence .....	91
3-Wire Initialization .....	88
3-Wire Sequence .....	91, 224
3-Wire Sequence Example .....	41

## A

A/D Conversion Error .....	128, 131
A1-01 .....	117, 215
A1-03 .....	88, 92, 215
A1-04 .....	117, 151, 215
A1-05 .....	117, 151, 215
A1 Initialization Parameters .....	215
Accel/Decel .....	94
Accel/Decel Ramp Hold .....	224
Accel/Decel Time .....	126
Accel/Decel Time 1 .....	224
Acceleration/Deceleration .....	92, 94
Acceleration Time 1 .....	93, 217
Acceleration Time 2 .....	217
Access Level Selection .....	117, 215
Accumulated Operation Time .....	110, 237
Accumulated Operation Time Selection .....	234
Accumulated Operation Time Setting .....	234
Alarm Causes and Solutions .....	141
Alarm Displays .....	141
Alarm Outputs for Maintenance Monitors .....	169
Alarms and Errors .....	127

Allowable Frequency Fluctuation .....	201, 203
Allowable Voltage Fluctuation .....	201, 203
Altitude Derating .....	212
Ambient Temperature Setting .....	211, 232
Analog Filter Time Constant .....	126
Analog Input Filter Time Constant .....	227

## B

b1-01 .....	88, 100, 152, 216
b1-02 .....	90, 91, 152, 216
b1-03 .....	92, 93
b1-04 .....	159, 216
b1-07 .....	216
b1-08 .....	216
b1-14 .....	216
b1-17 .....	216
b1 Operation Mode Selection .....	216
b2-02 .....	92, 157, 217
b2-03 .....	157, 217
b2-04 .....	92, 157, 217
b2 DC Injection Braking .....	217
Baseblock .....	141
Baseblock Command (N.C.) .....	224
Baseblock Command (N.O.) .....	224
bb .....	129, 141
Braking Resistor .....	64
Braking Resistor, Installation .....	64
Braking Resistor Overheat .....	139
Buzzing Sound from Motor at 2 kHz .....	158

## Index

<b>C</b>	
C1-01	84, 85, 92, 159
C1-02	93
C1-09	93, 217
C1 Acceleration and Deceleration Times	217
C2-01	218
C2-01 through C2-04	126
C2-02	218
C2-03	218
C2-04	218
C2 S-Curve Characteristics	217
C3-01	125
C3-02	218
C3 Slip Compensation	218
C4-01	125, 153
C4 Torque Compensation	218
C6-02	67, 125, 156, 157, 159, 160, 219
C6-03	219
C6-04	219
C6-05	157, 219
C6 Carrier Frequency	218
Cable Length Between Drive and Motor	49
CALL	129, 141
Cannot Change Parameter Settings	151
Can Not Reset	129, 142
Capacitor Maintenance	110, 237
Capacitor Maintenance Setting	235
Carrier Frequency Lower Limit	219
Carrier Frequency Proportional Gain	219
Carrier Frequency Reduction	232
Carrier Frequency Selection	125, 219
Carrier Frequency Setting Error	129, 148
Carrier Frequency Upper Limit	219
CE	128, 129, 130, 141
CE mark	245
clock error	131
Clock Fault	128
Closed-Loop Crimp Terminal Sizes	257
Coast to Stop	93
CoF	128, 130
Comm. Fault Detection Selection	228
Communication Parity Selection	227
Communication Speed Selection	227
Communications Test Mode	225
Connected Machinery Vibrates When Motor Rotates	157
Control Circuit Connection Diagram	52
Control Circuit Fault	128
Control Circuit Input Terminals	53
Control Circuit Output Terminals	54
Control Circuit Terminal Block Functions	53
Control Circuit Terminal Configuration	54
Cooling Fan Maintenance	110
Cooling Fan Maintenance Setting (Operation Time)	235
Cooling Fan Replacement	172
CPF02	131
CPF06	131
CPF08	131
CPF20	131
CPF21	131
CPF22	128, 131
CPF23	128, 132
CPF24	128, 132
CrST	129, 142
C Tuning	217
Current Fault	110, 237
Current Offset Fault	128, 130
<b>D</b>	
d1-01	97, 100
d1-02	97
d1-03	97
d1-04	97
d1 Frequency Reference	220
d2-01	158, 220
d2-02	220
d2 Frequency Upper and Lower Limits	220
d3-01	157, 221
d3-01 through d3-04	126
d3-02	221
d3-04	157, 221
d3 Jump Frequency	220
d4-01	221
d4 Frequency Reference Hold	221
DC Bus Pre-Charge Relay Maintenance Setting	235
DC Bus Undervoltage	139, 226
DC Bus Voltage	110, 235
DC Injection Braking at start	157
DC Injection Braking at Stop	157
DC Injection Braking Current	157, 217
DC Injection Braking Time/DC Excitation Time at Start	217



Deceleration Time 1 .....	93, 217	EF3 .....	132, 143
Deceleration Time 2 .....	217	EF4 .....	132, 143
Digital Operator Display Selection .....	233	EF5 .....	132, 143
DIP Switch S1 .....	62	Electrical Thermal Motor Protection .....	107
Down Command .....	224	EMC Guidelines .....	245
d References .....	220	Err. ....	133
Drive/kVA Selection .....	234	European Standards .....	245
Drive Baseblock .....	129	Excessive Motor Oscillation and Erratic Rotation .....	157
Drive Capacity Setting Fault .....	147	External Digital Operator Connection Fault .....	137
Drive Capacity Signal Fault .....	128	External Fault (user selection possible) .....	225
Drive Cooling Fans .....	167	External Search Command 1 .....	225
Drive Dedicated Motor (Constant Torque, 1:10) .....	109	External Search Command 2 .....	225
Drive Mode .....	79, 80, 81		
Drive Motor Overload Protection .....	260	<b>F</b>	
Drive Overload .....	128, 136	Fast-stop (N.C.) .....	224
Drive Ready .....	226	Fast-Stop (N.O.) .....	224
Drive Short-Circuit Rating .....	260	Fast-stop Time .....	217
Drive Slave Address .....	227	Fault .....	226
Drive Status Monitors .....	110	Fault Causes and Solutions .....	130
Drive Transmit Wait Time .....	228	Fault Detection .....	130
Drive Unit Setting Error .....	129	Fault Displays .....	130
Drive Watt Loss Data .....	209	Fault History Example .....	149
During Baseblock .....	226	Fault Reset .....	224
During Run .....	225	Fault Reset Example .....	127
Dynamic Braking Resistor .....	128	Faults .....	127, 128
		FLASH memory error .....	131
<b>E</b>		FLASH Memory Fault .....	128
E1-04 .....	155, 156, 158	Forward/Reverse Run Command Input Error .....	142
E1-06 .....	156	Forward Run Command (2-Wire sequence) .....	225
E1-08 .....	125, 153	Freq/Fout Agree 1 .....	225
E1-09 .....	152, 153, 158, 159	Frequency (FOUT) Detection 1 .....	225
E1-10 .....	125, 153, 156	Frequency (FOUT) Detection 2 .....	226
E1 V/f Pattern Characteristics .....	222	Frequency Reference .....	110, 235
E2-01 .....	108, 125, 222, 260	Frequency Reference 1 .....	97, 220
E2-02 .....	104, 125, 222	Frequency Reference 2 .....	97, 220
E2-03 .....	105, 125, 223	Frequency Reference 3 .....	97, 220
E2-05 .....	105, 223	Frequency Reference 4 .....	97, 220
E2 Motor Parameters .....	222	Frequency Reference 5 .....	220
EEPROM Data Error .....	131	Frequency Reference 6 .....	220
EEPROM Serial Communication Fault .....	131	Frequency Reference 7 .....	220
EEPROM Write Error .....	133	Frequency Reference 8 .....	220
EF .....	129, 142	Frequency Reference Hold Function Selection .....	221
EF0 .....	132	Frequency Reference Selection .....	216
EF1 .....	132, 143	Frequency Reference Selection 1 .....	152
EF1 to EF5 .....	129	Frequency Reference Setting Method Selection .....	234
EF2 .....	132, 143	Frequency Reference Upper Limit .....	220

Frequency Reference Wiring .....	58
Fuse (CE) .....	246, 247
Fuse Holder (CE) .....	247
Fuse Selection .....	246

## G

General-Purpose Motor (Standard Self-Cooled) .....	109
General Safety Information .....	11
Ground Fault Interrupter Activates When Drive is Running .....	160
Ground Wiring .....	49

## H

H1-01 .....	223
H1-02 .....	223
H1-03 .....	223
H1-04 .....	223
H1-05 .....	41, 223
H1 Multi-Function Digital Input .....	223
H1 Multi-Function Digital Input Selections .....	224
H2-01 .....	105, 225
H2 Multi-Function Digital Outputs .....	225
H2 Multi-Function Digital Output Settings .....	225
H3-01 .....	63, 152, 226
H3-01 Details .....	63
H3-13 .....	126, 157
H3 Analog Input A1 .....	226
H4-01 .....	227
H4-03 .....	227
H4 Multi-Function Analog Output AM .....	227
H5-01 .....	227
H5-02 .....	227
H5-03 .....	227
H5-04 .....	228
H5-05 .....	228
H5-06 .....	228
H5-07 .....	228
H5-12 .....	228
H5-13 .....	228
H5 MEMOBUS/Modbus Communications .....	227
Heatsink Cooling Fan Operation Selection .....	232
Heatsink Overheat .....	128, 129, 143
Heatsink Temperature .....	111
Heavy Duty Ratings .....	200
Hunting Prevention Gain .....	125
Hunting Prevention Gain Setting .....	233

## I

I/O Connections .....	39
IGBT Maintenance .....	111, 237
IGBT Maintenance Setting .....	235
Initialize Parameters .....	88, 215
Initial Operation .....	87
Input Current (A) .....	201, 203
Input Fuses .....	246
Input Phase Loss .....	128, 138
Input Terminals .....	86
Input Terminal Status .....	110
Input Voltage Setting .....	222
Inrush Prevention Circuit Fault .....	140
Inspection .....	165, 167
Installation Environment .....	29
Installation Orientation .....	30
Installation Spacing .....	30
Installing Multiple Drives .....	31
Internal Dynamic Braking Resistor Protection .....	65
Internal Dynamic Braking Resistor Protection Selection (ERF type) .....	231

## J

Jog Frequency Reference .....	220
Jog Reference Selection .....	224
Jump Frequency .....	126
Jump Frequency 1 .....	221
Jump Frequency 2 .....	221
Jump Frequency Width .....	221

## L

L1-01 .....	108, 109, 110, 229, 260, 261
L1-02 .....	108, 229, 261
L1-13 .....	229
L1 Motor Protection Functions .....	229
L2-01 .....	229
L2 Momentary Power Loss .....	229
L3-01 .....	230
L3-01 through L3-06 .....	126
L3-02 .....	155, 158, 230
L3-04 .....	156, 230
L3-05 .....	230
L3-06 .....	155, 230
L3 Stall Prevention Function .....	229
L4-01 .....	230
L4 Frequency Detection .....	230

L5-01 .....	231	Memobus/Modbus Error Code .....	110
L5 Fault Reset .....	231	MEMOBUS/Modbus Test Mode Complete .....	129
L6-01 .....	231	MEMOBUS/Modbus Test Mode Fault .....	129
L6-02 .....	231	Mid Output Voltage A .....	125
L6-03 .....	231	Minimum Output Frequency .....	158, 159
L6 Overtorque Detection .....	231	Minimum Output Voltage .....	125
L8: Hardware Protection .....	231	Minor Alarms .....	128
L8-01 .....	231	Minor Faults .....	127, 128
L8-10 .....	232	Modes .....	79
L8-12 .....	211, 232	Momentary Power Loss Operation Selection .....	229
L8-18 .....	232	Monitor Output .....	54
L8-29 .....	211	Motor Does Not Operate When an External Run Command is Input .....	158
L8-35 .....	232	Motor Does Not Operate When the RUN Button on the Digital Operator is Pressed .....	158
L8-38 .....	158, 232	Motor Does Not Rotate .....	152
LED Check .....	111, 237	Motor Hunting and Oscillation Control Parameters ..	126
LED Operator .....	22, 74, 75, 90	Motor Hunting Occurs When Operating With a Light Load .....	156
LF .....	128, 133	Motor is Too Hot .....	154
LO/RE .....	76, 85, 114	Motor Line-to-Line Resistance .....	105, 223
LOCAL .....	85	Motor No-Load Current .....	105, 223
Local/Remote Run Selection .....	216	Motor Overload .....	128, 135
Local/Remote Selection .....	224	Motor Overload Protection Selection .....	108, 229, 260
Low Voltage Directive .....	245	Motor Overload Protection Time .....	108, 229, 261
Low Voltage Wiring .....	260	Motor Parameters .....	104
L Protection Function .....	229	Motor protection operation time .....	109
<b>M</b>			
Magnetic Flux Compensation Capacity .....	217	Motor Rated Current .....	104, 108, 222, 260
Main Circuit Connection Diagram .....	42, 51	Motor Rated Slip .....	104, 222
Main Circuit Terminal Functions .....	46	Motor Rotates After the Drive Output is Shut Off ...	157
Main Circuit Terminal Power Supply .....	49	Motor Rotates Faster Than the Frequency Reference ..	155
Main Circuit Terminals Connection .....	42	Motor Rotates in One Direction Only .....	159
Main Circuit Terminal Wiring .....	24, 254	Motor Stalls During Acceleration or With Large Loads	154
Main Frequency Reference .....	62	Motor Stops During Acceleration or When a Load is Connected .....	159
Main Frequency Reference Input .....	53	Motor Wiring .....	49
Maintenance Alarms .....	169	Multi-Function Analog 1 (Terminal AM Monitor Selection) .....	227
Master Speed Reference Lower Limit .....	220	Multi-Function Analog Outputs .....	105
Maximum Motor Size Allowed (HP) .....	201	Multi-Function Contact Input .....	98
Maximum Motor Size Allowed (kW) .....	203	Multi-Function Contact Output .....	105
Maximum Output Frequency .....	222	Multi-Function Digital Inputs .....	53
MEMOBUS/Modbus Communication Error ... 128, 129, 130, 141		Multi-Function Digital Input Terminal S1 Function Selection .....	223
MEMOBUS/Modbus Communications Test Mode Complete .....	145	Multi-Function Digital Input Terminal S2 Function Selection .....	223
MEMOBUS/Modbus Communications Test Mode Error .....	145		
MEMOBUS/Modbus Error Code .....	236		

## Index

Multi-Function Digital Input Terminal S3 Function Selection .....	223	oPE .....	147
Multi-Function Digital Input Terminal S4 Function Selection .....	223	oPE01 .....	129, 147
Multi-Function Digital Input Terminal S5 Function Selection .....	223	oPE02 .....	129, 147
Multi-Function Digital Output .....	54	oPE03 .....	129, 147
Multi-Function Input Selection Error .....	147	oPE05 .....	129, 148
Multi-Function Input Setting Error .....	129	oPE10 .....	129, 148
Multiple Drive Wiring .....	50	oPE11 .....	129, 148
Multi-Step Speed Operation (4-Step Speed) .....	97	Open-Chassis IP20 .....	32, 33
Multi-Step Speed Reference .....	224	Operating with the Load Connected .....	116
<b>N</b>		Operation Errors .....	127, 129
n1-02 .....	125, 233	Operator Connection Fault .....	128
n1 Hunting Prevention .....	233	Operator Programming Errors .....	147
n3: Overexcitation Braking .....	233	Operator Related Parameters .....	233
n3-13 .....	233	oPr .....	128, 137
n Advanced Performance Set Up .....	233	Option Card Fault .....	135
Noise From the Drive or Output Lines When the Drive is Powered On .....	156	Option Unit Fault .....	128
No-Load Operation .....	114	Oscillation or Hunting .....	157
Normal Duty Ratings .....	200	Output Current .....	110, 235
Number of Auto Restart Attempts .....	231	Output Current (A) .....	201, 203
<b>O</b>		Output Frequency .....	110, 235
o1 Display Settings .....	233	Output Frequency is not as High as Frequency Reference .....	158
o2-02 .....	153, 233	Output Phase Loss .....	128, 133
o2-04 .....	234	Output Terminal Status .....	110, 236
o2-05 .....	234	Output Voltage Reference .....	110, 235
o2 Multi-Function Selections .....	233	ov .....	128, 129, 137, 144
o4-01 .....	234	Overcurrent .....	128, 133
o4-02 .....	234	Overexcitation Deceleration Gain .....	233
o4-03 .....	235	Overheat 1 (Heatsink Overheat) .....	135
o4-05 .....	235	Overload Tolerance .....	201, 203
o4-07 .....	235	Overtorque 1 .....	129, 144
o4-09 .....	235	Overtorque Detection 1 .....	128, 137
o4-11 .....	235	Overvoltage .....	128, 129, 137
o4 Maintenance Period .....	234	ov Occurs When Starting a Fan or Motor Speed Loss Occurs .....	157
oC .....	128, 133	<b>P</b>	
oFA01 .....	128, 135	Parameter Range Setting Error .....	147
oH .....	129, 143	Parameter Setting Range Error .....	129
oH1 .....	128, 135	Parameter Settings .....	83
oL1 .....	128, 135	PASS .....	129, 145
oL2 .....	128, 136, 158	Password .....	215
oL3 .....	128, 129, 137, 144	Password Setting .....	215
		Password Settings .....	117
		Peak Hold Current .....	111, 237
		Peripheral Devices Affected by Drive Operation .....	159

PF .....	128, 138	Serial Communication Transmission Error .....	129, 141
Phase Order Selection .....	216	Setup Mode .....	81, 86
Poor Speed Control Accuracy .....	155	Shielded Twisted-Pair Cables .....	57
Power Specifications 200 V Class Models .....	201	Side-by-Side Setup .....	31
Power Specifications 400 V Class Models .....	203	Sinking/Sourcing Mode Switch .....	24
Previous Fault .....	110, 237	Slip Compensation Gain .....	218
Programming Mode .....	79, 81, 82	Slip Compensation Primary Delay Time .....	218
Protective Covers, Reattaching .....	197	Soft Charge Circuit Fault .....	128
Protective Covers, Removing .....	44, 196	Soft Current Limit Selection .....	232
PWM Feedback Data Fault .....	128	Software No. (Flash) .....	236
PWM Feedback Fault .....	132	Software No. (ROM) .....	236
<b>R</b>		Software Number (Flash) .....	110
RAM Fault .....	128, 131	Software Number (ROM) .....	110
Ramp to Stop .....	92	Speed Agreement Detection Level .....	230
Rated Frequency .....	201, 203	Speed Search .....	226
Rated Output Capacity (kVA) .....	201	Stall Prevention .....	126
Rated Voltage .....	201, 203	Stall Prevention During Deceleration .....	65
REMOTE .....	85	Stall Prevention Level during Acceleration .....	230
Replacement Parts .....	211	Stall Prevention Level during Run .....	230
Restart Enabled .....	226	Stall Prevention Selection during Acceleration .....	230
Reverse Direction .....	226	Stall Prevention Selection during Deceleration .....	230
Reverse Operation Selection .....	216	Stall Prevention Selection during Run .....	230
Reverse Run Command (2-Wire sequence) .....	225	Standard Connection Diagram .....	39, 40
rH .....	128, 139	STOP Key Function Selection .....	233
RTS Control Selection .....	228	Stopping Method .....	92
Run command .....	93	Stopping Method After Communication Error .....	228
Run Command at Power Up .....	216	<b>T</b>	
Run Command Input Error .....	129	Terminal A1 Bias Setting .....	226
Run Command Input Selection .....	90	Terminal A1 Gain Setting .....	226
Run Command Selection .....	152, 216	Terminal A1 Input Voltage .....	110
Run Command Selection during Program .....	216	Terminal A1 Signal Level Selection .....	226
Run Command Selection Error .....	129	Terminal Block Configuration .....	43
<b>S</b>		Terminal Board Wiring Guide .....	57
S1 .....	91	Terminal M1 thru M2 Function Selection (relay) .....	105
S2 .....	91	Terminal MA, MB and MC Function Selection (relay) .....	105, 225
Safety Hazard Definitions .....	11	Test Run .....	115
Safety Information .....	11	Tightening Torque .....	46
S-Curve Characteristic at Accel End .....	218	Timing Fault .....	128
S-Curve Characteristic at Accel Start .....	218	Torque Compensation Gain .....	125, 218
S-Curve Characteristic at Decel End .....	218	Torque Detection 1 (N.O.) .....	226
S-Curve Characteristic at Decel Start .....	218	Torque Detection 2 (N.O.) .....	226
S-Curve Characteristics .....	94, 126	Torque Detection Level 1 .....	231
SE .....	129, 145	Torque Detection Selection 1 .....	231
Serial Communication Reference Selection .....	224	Torque Detection Time 1 .....	231

## Index

---

Torque Specifications, Single Phase 200 V Class .	47, 255	Verify Menu .....	81
Torque Specifications, Three Phase 200 V Class .	47, 255	<b>W</b>	
Torque Specifications, Three Phase 400 V Class .	48, 256	Watchdog Circuit Exception .....	128, 131
Transistor Input Signal .....	60, 61	Watt Loss 200 V Class Single Phase Models .....	209
<b>U</b>		Watt Loss 200 V Class Three Phase Models .....	209
U1-01.....	110, 152, 155, 235	Watt Loss 400 V Class Three Phase Models .....	209
U1-02.....	110, 235	Wire Gauge, Single Phase 200 V Class .....	47, 255
U1-03.....	110, 235	Wire Gauge, Three Phase 200 V Class.....	47, 255
U1-06.....	110, 235	Wire Gauge, Three Phase 400 V Class.....	48, 256
U1-07.....	110, 151, 235	Wire Gauges .....	46
U1-09.....	152	Wiring Checklist .....	67
U1-10.....	110	Wiring Procedure .....	56
U1-11.....	110, 236	<b>Z</b>	
U1-13.....	110, 236	Zero Speed .....	225
U1-19.....	110, 236		
U1-25.....	110, 236		
U1-26.....	110, 236		
U1 Operation Status Monitors .....	235		
U2-01.....	110, 237		
U2-02.....	110, 149, 237		
U2 Fault History.....	237		
U2 Initialization .....	235		
U4: Maintenance Monitors .....	237		
U4-01.....	110		
U4-04.....	110		
U4-05.....	110, 237		
U4-06.....	237		
U4-07.....	111, 237		
U4-08.....	111, 237		
U4-09.....	111, 237		
U4-13.....	111, 237		
UL Standards.....	254		
U Monitors .....	235		
Undervoltage .....	128, 129, 145		
Undervoltage 3 .....	140		
Unexpected Noise from Connected Machinery .....	157		
Up Command .....	224		
User Monitor Selection After Power Up .....	233		
Uv .....	129, 145		
Uv1 .....	128, 139		
Uv3 .....	128, 140		
<b>V</b>			
V/f Data Setting Error .....	129, 148		
V/f Pattern Selection .....	222		

**This Page Intentionally Blank**

## Revision History

The revision dates and the numbers of the revised manuals appear on the bottom of the back cover.

MANUAL NO.

TOEP C710606 26A <1>

Revision number

Published in Japan July 2009

Date of publication

Date of Publication	Revision Number	Section	Revised Content
May 2015	<4>	Front Cover, Spine	Revision: Format
		All	Revision: Reviewed and corrected documentation
		Chapter 3	Addition: Safety message regarding motor leads
		Appendix C	Revision: UL Factory Recommended Branch Circuit Protection
		Back Cover	Revision: Format and address
March 2014	<3>	All	Revision: Reviewed and corrected documentation
		Chapter 2	Revision: Ambient Temperature
		Appendix A	Revision: Ambient Temperature Revision: Standards
		Appendix C	Addition: Fuse List for European Standards Addition: Ambient Temperature for UL Standards Revision: Wire Gauge and Torque Specifications for UL Standards Revision: Standards Revision: Low Voltage Wiring for Control Circuit Terminals
		Back Cover	Revision: Address
December 2011	<2>	Front Cover	Revision: Format
		All	Revision: Reviewed and corrected documentation
		Chapter 3 Chapter 7	Revision: Precautions on installing a leakage breaker Revision: Wire Gauge and Torque Specifications
		Appendix C	Revision: Wire Gauge and Torque Specifications Revision: Closed-Loop Crimp Terminal Size Revision: Fuse list
		Back Cover	Revision: Format and address
July 2009	<1>	Back Cover	Revision: Address
February 2008	-	-	First Edition





# YASKAWA AC Drive-J1000

## Compact V/f Control Drive

## Quick Start Guide

---

### YASKAWA AMERICA, INC.

2121, Norman Drive South, Waukegan, IL 60085, U.S.A.  
Phone: 1-800-YASKAWA (927-5292) or 1-847-887-7000 Fax: 1-847-887-7310  
<http://www.yaskawa.com>

### DRIVE CENTER (INVERTER PLANT)

2-13-1, Nishimiyaichi, Yukuhashi, Fukuoka, 824-8511, Japan  
Phone: 81-930-25-3844 Fax: 81-930-25-4369  
<http://www.yaskawa.co.jp>

### YASKAWA ELECTRIC CORPORATION

New Pier Takeshiba South Tower, 1-16-1, Kaigan, Minatoku, Tokyo, 105-6891, Japan  
Phone: 81-3-5402-4502 Fax: 81-3-5402-4580  
<http://www.yaskawa.co.jp>

### YASKAWA ELÉTRICO DO BRASIL LTDA.

777, Avenida Piraporinha, Diadema, São Paulo, 09950-000, Brasil  
Phone: 55-11-3585-1100 Fax: 55-11-3585-1187  
<http://www.yaskawa.com.br>

### YASKAWA EUROPE GmbH

185, Hauptstraße, Eschborn, 65760, Germany  
Phone: 49-6196-569-300 Fax: 49-6196-569-398  
<http://www.yaskawa.eu.com>

### YASKAWA ELECTRIC KOREA CORPORATION

9F, Kyobo Securities Bldg., 26-4, Yeouido-dong, Yeongdeungpo-gu, Seoul, 150-737, Korea  
Phone: 82-2-784-7844 Fax: 82-2-784-8495  
<http://www.yaskawa.co.kr>

### YASKAWA ELECTRIC (SINGAPORE) PTE. LTD.

151, Lorong Chuan, #04-02A, New Tech Park, 556741, Singapore  
Phone: 65-6282-3003 Fax: 65-6289-3003  
<http://www.yaskawa.com.sg>

### YASKAWA ELECTRIC (THAILAND) CO., LTD.

252/125-126, 27/1 Floor, Muang Thai-Pratra Tower B, Rachadapisek Road, Huaykwang, Bangkok, 10310, Thailand  
Phone: 66-2693-2200 Fax: 66-2693-4200  
<http://www.yaskawa.co.th>

### YASKAWA ELECTRIC (CHINA) CO., LTD.

22F, One Corporate Avenue, No.222, Hubin Road, Shanghai, 200021, China  
Phone: 86-21-5385-2200 Fax: 86-21-5385-3299  
<http://www.yaskawa.com.cn>

### YASKAWA ELECTRIC (CHINA) CO., LTD. BEIJING OFFICE

Room 1011, Tower W3 Oriental Plaza, No. 1, East Chang An Ave.,  
Dong Cheng District, Beijing, 100738, China  
Phone: 86-10-8518-4086 Fax: 86-10-8518-4082

### YASKAWA ELECTRIC TAIWAN CORPORATION

9F, 16, Nanking E. Rd., Sec. 3, Taipei, 104, Taiwan  
Phone: 886-2-2502-5003 Fax: 886-2-2505-1280

### YASKAWA INDIA PRIVATE LIMITED

#17A, Electronics City, Hosur Road, Bangalore, 560 100 (Karnataka), India  
Phone: 91-80-4244-1900 Fax: 91-80-4244-1901  
<http://www.yaskawaindia.in>

---

# YASKAWA

YASKAWA ELECTRIC CORPORATION

In the event that the end user of this product is to be the military and said product is to be employed in any weapons systems or the manufacture thereof, the export will fall under the relevant regulations as stipulated in the Foreign Exchange and Foreign Trade Regulations. Therefore, be sure to follow all procedures and submit all relevant documentation according to any and all rules, regulations and laws that may apply.

Specifications are subject to change without notice for ongoing product modifications and improvements.

© 2008-2015 YASKAWA ELECTRIC CORPORATION



\*TOEPC71060626\*

MANUAL NO.  
TOEP C710606 26D <4>  
Published in Japan May 2015  
14-10-13\_YAI